

ESTADO LIBRE ASOCIADO DE PUERTO RICO  
DEPARTAMENTO DE SALUD  
PUERTO RICO

Programa Graduado de Demografía



**CDCES** CENTRO DE  
DATOS CENSALES  
Y ESTADÍSTICAS  
DE SALUD  
Recinto de Ciencias Médicas  
Programa Graduado de Demografía



*Secretaría Auxiliar de Planificación, Evaluación,  
Estadísticas y Sistemas de Información  
División de Estadísticas  
San Juan, Puerto Rico*

**ESTADO LIBRE ASOCIADO DE PUERTO RICO  
DEPARTAMENTO DE SALUD  
SECRETARIA AUXILIAR DE PLANIFICACIÓN,  
EVALUACIÓN, ESTADÍSTICA  
Y SISTEMAS DE INFORMACION**

**RESUMEN DE ESTADISTICAS  
VITALES  
PUERTO RICO, 1999**

**San Juan, Puerto Rico  
Mayo de 2002**

**DEPARTAMENTO DE SALUD**

**DR. JOHNNY RULLAN  
SECRETARIO DE SALUD**

**SECRETARÍA AUXILIAR DE PLANIFICACIÓN, EVALUACIÓN,  
ESTADÍSTICAS Y SISTEMAS DE INFORMACIÓN**

**DALIDIA COLON, SECRETARIA AUXILIAR**

**Esta publicación fue preparada por:**

**Mario R. Zuleta, Consultor en Demografía  
Sonia M. González, Estadístico  
Orlando Rosado, Estadístico  
Ivette Rolland, Estadístico  
Yairellys Cruz, Oficinista Dactilógrafo  
Ruth Arocho, Oficinista**

**Los datos en este Informe son públicos, sin embargo, se requiere que, en caso de ser citados o divulgados, se reconozca apropiadamente la fuente de donde proviene la información.**

**Cita sugerida: Resumen de Estadísticas Vitales de Puerto Rico, 1999  
Departamento de Salud, SAPEESI, San Juan, Puerto Rico**

## **TABLA DE CONTENIDO**

<b>INTRODUCCIÓN.....</b>	<b>1</b>
<b>DATOS SOBRESALIENTES .....</b>	<b>6</b>
<b>ESTADÍSTICAS DEMOGRÁFICAS GENERALES .....</b>	<b>10</b>
<b>NACIMIENTOS VIVOS.....</b>	<b>17</b>
<b>MORTALIDAD GENERAL.....</b>	<b>23</b>
<b>MUERTES FETALES.....</b>	<b>39</b>
<b>MORTALIDAD INFANTIL.....</b>	<b>43</b>
<b>MORTALIDAD MATERNA.....</b>	<b>48</b>
<b>MATRIMONIOS Y DIVORCIOS.....</b>	<b>51</b>
<b>TABLAS DE VIDA.....</b>	<b>56</b>

## **RESUMEN DE ESTADÍSTICAS VITALES PUERTO RICO, 1999**

### **INTRODUCCIÓN**

**El Departamento de Salud, pone a disposición de las instituciones públicas, privadas y usuarios en general, el documento: Resumen de Estadísticas Vitales 1999. El mismo forma parte de la serie de documentos de Estadísticas Vitales que publica el Departamento de Salud con la finalidad de ofrecer información para un mayor conocimiento de la dinámica poblacional.**

**El documento contiene información de los nacimientos, matrimonios y defunciones inscritos en las oficinas del Registro Demográfico durante el año 1999, asimismo se presentan datos de los divorcios registrados en el mismo periodo.**

**Por otra parte, cabe mencionar que el Departamento de Salud se encuentra en proceso de actualización y fortalecimiento de los sistemas de producción de información en salud. El mismo, contempla entre otros, la implantación de la Décima Clasificación Internacional de Enfermedades (CIE-10), que dicho sea de paso, fue la que se utilizó para la tabulación de datos de mortalidad presentados en esta publicación.**

**Confiamos en que la información presentada en este documento, servirá de insumo para estudios e investigaciones especiales que permitan conocer la situación social en general y del campo de la salud en particular.**

# EVENTOS VITALES PUERTO RICO, 1999

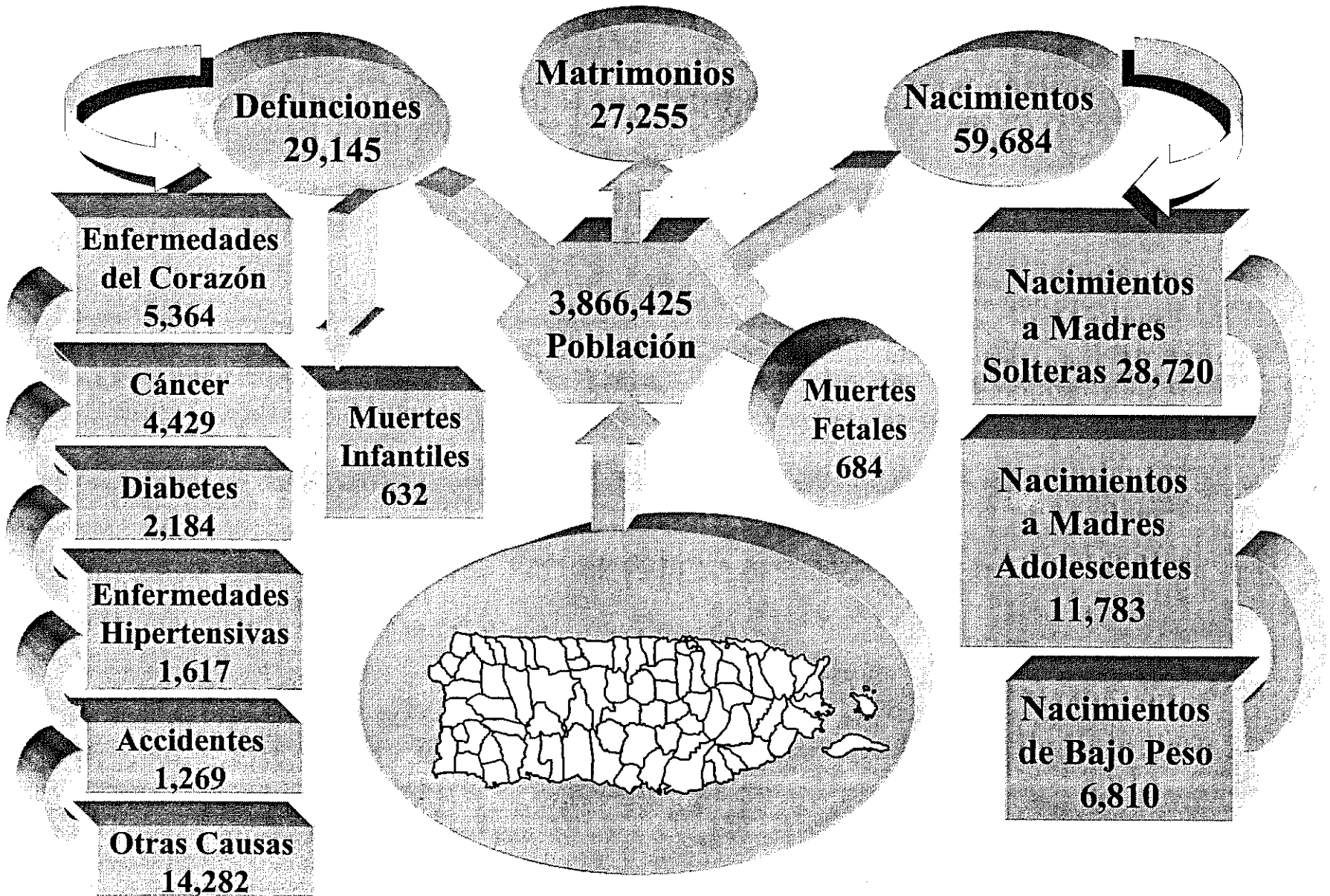



# CADA DIA EN 1999

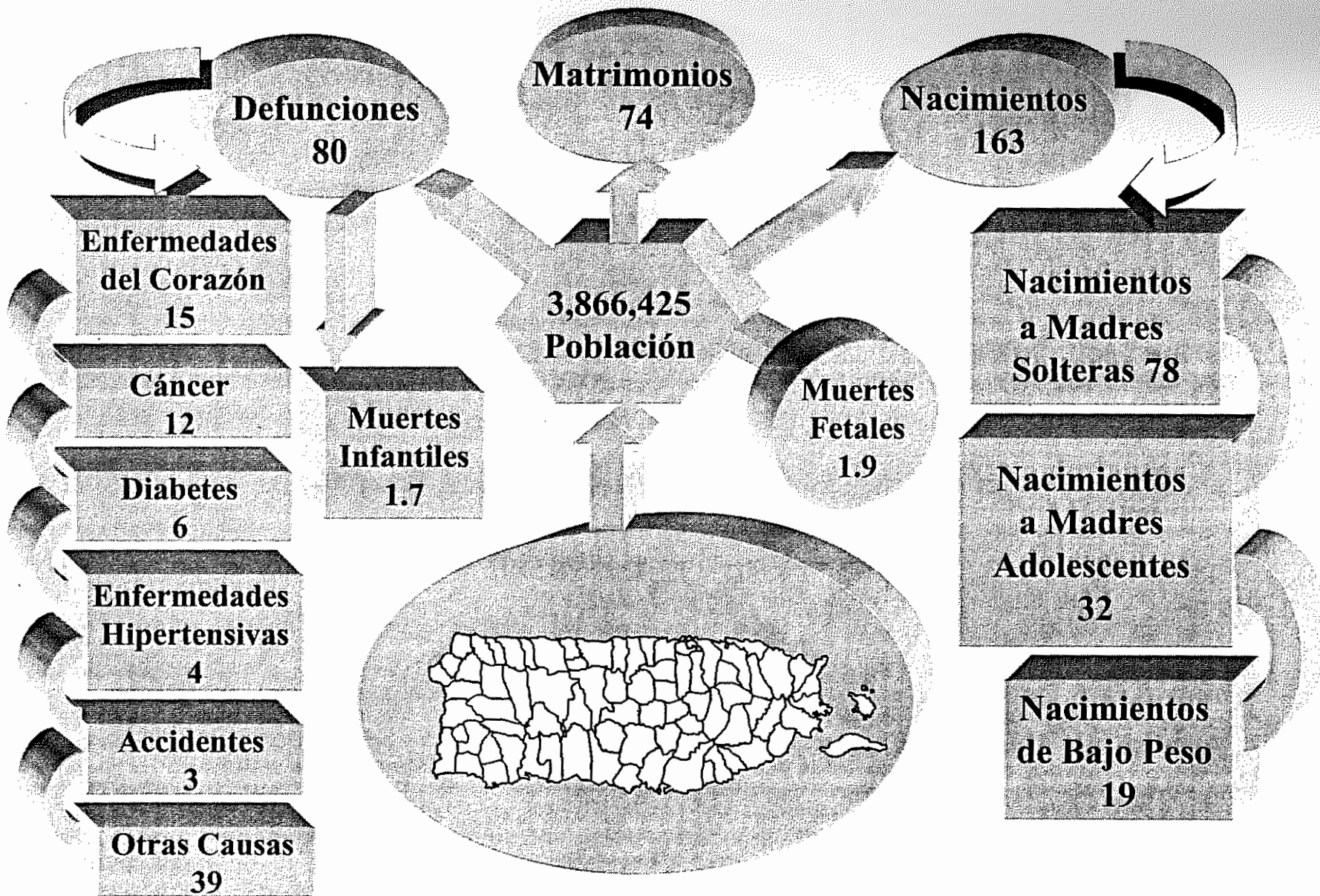

## RESUMEN DEMOGRAFICO

<b>Eventos y Tasas</b>	<b>1999</b>	<b>1998</b>
<b>Población Total<sup>1</sup></b>	<b>3,866,426</b>	<b>3,833,482</b>
<b>Nacimientos</b>	<b>59,684</b>	<b>60,518</b>
<b>Tasa Bruta de Natalidad</b>	<b>15.4</b>	<b>15.8</b>
<b>Defunciones</b>	<b>29,145</b>	<b>29,990</b>
<b>Tasa Bruta de Mortalidad</b>	<b>7.5</b>	<b>7.8</b>
<b>Muertes Infantiles</b>	<b>632</b>	<b>637</b>
<b>Tasa de Mortalidad Infantil</b>	<b>10.6</b>	<b>10.5</b>
<b>Muertes Neonatales</b>	<b>438</b>	<b>466</b>
<b>Tasa de Mortalidad Neonatal</b>	<b>7.3</b>	<b>7.7</b>
<b>Muertes Postneonatales</b>	<b>193</b>	<b>170</b>
<b>Tasa de Mortalidad Postneonatal</b>	<b>3.2</b>	<b>2.8</b>
<b>Muertes Fetales</b>	<b>684</b>	<b>692</b>
<b>Tasa Mortalidad Fetal</b>	<b>11.3</b>	<b>11.3</b>
<b>Muertes Maternas</b>	<b>11</b>	<b>4</b>
<b>Tasa de Mortalidad Materna</b>	<b>18.4</b>	<b>6.6</b>
<b>Matrimonios</b>	<b>27,255</b>	<b>26,760</b>
<b>Tasa de Matrimonios<sup>2</sup></b>	<b>9.3</b>	<b>9.3</b>
<b>Divorcios</b>	<b>15,527</b>	<b>13,832</b>
<b>Tasa de Divorcios<sup>2</sup></b>	<b>5.3</b>	<b>4.8</b>

1) Estimada por la Junta de Planificación al 1ro de julio.

2) Tasa por 1,000 habitantes mayores de 15 años.



## **POBLACIÓN**

**En 1999, la población estimada para Puerto Rico, fue de 3,866,426 habitantes; 0.9 por ciento mayor que en 1998 (3,833,482). Unas 30,539 personas se sumaron a la población total como producto del crecimiento natural (la diferencia entre 59,684 nacimientos y 29,145 defunciones).**

## **NACIMIENTOS**

**Hubo un total de 59,684 nacimientos, de los cuales 59,546 nacimientos (99.8%) ocurrieron en hospitales. El 33.9 por ciento (29,231) de los nacimientos ocurridos en hospitales fueron en hospitales del gobierno y el 65.9 por ciento (39,315) en hospitales privados. Un total de 138 nacimientos ocurrieron en el hogar y otros lugares.**

**Unos 6,810 nacimientos fueron de bajo peso al nacer (5 lbs. 8 oz. o menos), lo que representa una proporción de 11.4 por ciento. Para el año 1998, la proporción fue de 10.9 por ciento. La proporción de muy bajo peso (3 lbs. 4 oz. o menos) fue de 1.3 con 797 nacimientos (1.3% en 1998 con 804 nacimientos). Del total de nacimientos de bajo peso (6,810) el 23.5 por ciento (1,597) fueron de madres adolescentes.**

**Hubo 11,783, (19.7%). nacimientos a madres menores de 20 años (madres adolescentes). La proporción observada en 1998 fue de 20.4 por ciento (12,327 nacimientos). Lo que refleja una reducción de 3.4 por ciento en los nacimientos a madres menores de 20 años.**

**El 48.1 por ciento (28,720) de los nacimientos fueron a madres solteras. Esta proporción fue de 46.9 por ciento en 1998 y continúa en aumento ininterrumpido desde 1977, cuando fue de 18.6 por ciento. En el 73.1 por ciento de los nacimientos a madres adolescentes, éstas eran solteras (8,610 de 11,783).**

**En el 77.4 por ciento (46,179) de los nacimientos, las madres comenzaron el cuidado prenatal en el primer trimestre de embarazo. Esta proporción fue de 78.6 por ciento en el año 1998 (47,552).**

Unos 22,572 nacimientos (37.8 %) fueron por cesárea, siendo los hospitales privados los que reportan la tasa mayor de cesáreas. Para 1998, estos nacimientos fueron 21,230 (35.1%). Se refleja un aumento en los nacimientos por cesárea de 1,342 (6.3%).

### **MORTALIDAD GENERAL**

Las Enfermedades del Corazón y los Neoplasmas Malignos (Cáncer) fueron las dos principales causas de muerte, responsables en conjunto del 33.6 por ciento (9,793) del total de defunciones. Las Enfermedades del Corazón (18.4%) continúan siendo la primera causa de muerte. Unas 5,364 personas murieron por esta causa en este período y para 1998 murieron 6,038 personas por esta misma causa.

Las Enfermedades Cardiovasculares (incluyendo aquí las enfermedades del corazón, cerebrovasculares, hipertensión y arterioesclerosis), causaron 8,429 muertes, lo que equivale al 28.9 por ciento del total de muertes ocurridas.

Los Tumores Malignos (Cáncer) ocuparon el segundo lugar de las causas de muerte con 4,429 muertes, para un 15.2 por ciento del total de las muertes. Entre las mujeres hubo un total de 1,840 muertes por cáncer y entre los hombres hubo 2,589. Ocurrieron 402 muertes de Cáncer del Colon, 448 de Cáncer de Próstata y 308 de Cáncer de la Mama de la Mujer.

La Diabetes Mellitus ocupó el tercer lugar (desde 1989 ocupa este lugar), por esta causa murieron 2,184 personas, el 7.5 por ciento del total de muertes en 1999. En el año 1998 las muertes por esta causa fueron 2,295 (111 muertes más que en 1999).

Para 1999, la causa que ocupó el cuarto lugar fueron las Enfermedades Hipertensivas con 1,617 muertes equivalentes al 5.5 por ciento del total. Esta causa ocupó el quinto lugar para 1998 con 1,395 muertes.

El quinto lugar es ocupado por los Accidentes con 1,269 muertes. Esta causa ocupó el sexto lugar en 1998 con 1,387 muertes.

Las Enfermedades Cerebrovasculares ocupan el sexto lugar con 1,266 muertes (4.3%), mientras que para 1998 ocuparon el cuarto lugar con 1,420 muertes.

El séptimo lugar es ocupado por la Enfermedad Pulmonar Obstructiva Crónica (COPD por sus siglas en Inglés), esta causó 1,240 defunciones (4.3%). Esta causa, incluye las muertes por bronquitis, enfisema, asma, bronquiectasia, alveolitis alérgica y bronquitis.

La Neumonía e Influenza ocupan el octavo lugar con 1,069 (3.7%) muertes. En 1998 esta causa ocupó el octavo lugar, causando 1,314 muertes (4.4%).

El noveno lugar fue ocupado por Nefritis y Nefrosis que causó 937 (3.2%) muertes. Esta causa ocupó el decimocuarto lugar en 1998 y causó 538 (1.8%) muertes.

Las Enfermedades del Hígado y Cirrosis fueron la décima causa con 878 (3.0%) muertes. Para 1998 esta causa ocupó el décimo lugar con 672 (2.2%) muertes.

El undécimo lugar fue ocupado por Septicemia con 726 (2.5%). En 1998 esta causa ocupó el mismo lugar que en 1999 con 599 (2.0%) muertes.

Los Homicidios e Intervención Legal ocuparon el lugar 12 con 705 (2.4%) muertes. Mientras que para 1998, estos ocuparon el noveno lugar con 819 muertes.

Para 1999 la Infección por el Virus de Inmunodeficiencia Humana, virus causante del Síndrome de Inmunodeficiencia Adquirida (SIDA), ocupó el lugar número trece con 610 muertes, mientras que en 1998 ocupó el decimocuarto lugar con 582 muertes.

Alzheimer y las Enfermedades Originadas en el Período Perinatal ocuparon el decimocuarto y decimoquinto con 587 y 400 muertes, respectivamente.

### **MORTALIDAD INFANTIL**

En el año 1999 ocurrieron 632 muertes infantiles con una tasa de 10.6 por cada mil nacimientos vivos. Se reportaron 5 muertes infantiles menos que en el 1998 (637 muertes infantiles).

De las 632 muertes de menores de un año ocurridas en Puerto Rico para 1999, 438 muertes ocurrieron en el período neonatal (menores de 28 días de vida) y 193 ocurrieron en el período postneonatal (desde los 28 días, pero sin lograr alcanzar su primer año).

## **MORTALIDAD FETAL Y MATERNA**

**Para el año 1999, se informaron 684 muertes fetales, lo que representa una tasa de 11.5 por cada mil nacidos vivos. La mortalidad fetal para 1999 se redujo en 8 muertes con relación a las muertes fetales reportadas para 1998 (692 muertes con una tasa de 11.4 por cada 1,000 nacidos vivos).**

**Las muertes maternas reportadas para 1999, fueron 12. Esto representa una tasa de 18.4. Para 1998, se reportaron 4 muertes maternas con una tasa de 6.6 por cada 100,000 nacidos vivos.**

## **MATRIMONIOS**

**Se celebraron 27,255 matrimonios, 495 más que en 1998 (26,760). La tasa de matrimonios por cada mil habitantes mayores de quince años fue de 9.3, tanto para 1999 como para 1998. El mayor número de matrimonios se produjo en el grupo 20 a 24 años para las mujeres (8,420) y en el de 24 a 29 años para los hombres (6,538). Los matrimonios por primera vez fueron 17,067 (62.2%) del total de matrimonios. De estos, el grupo de edad con el mayor número de matrimonios correspondió al de 20 a 24 años para ambos sexos.**

## **DIVORCIOS**

**Se informaron 15,527 divorcios, 1,695 divorcios más que el período anterior, lo que representa una tasa de 5.3 por cada mil habitantes de quince años o más. En 1998 la tasa fue de 4.8. Del total de divorcios concedidos, 7,792 (50.2%) fueron por consentimiento mutuo y 4,517 (29.1%) por separación por más de dos años. El mes con mayor número de divorcios concedidos fue el de junio con 1,529 divorcios.**

Tabla 1 - ESTADÍSTICAS DEMOGRÁFICAS EN PUERTO RICO POR AÑOS  
Table 1 - DEMOGRAPHIC STATISTICS IN PUERTO RICO BY YEARS  
PUERTO RICO, 1999

Años Years	POBLACION * POPULATION	Nacimientos Vivos Live Births		Mortalidad General Total Deaths		Mortalidad Infantil Infant Deaths		Muertes Maternas Maternal Deaths		Mortinatos Stillbirths		Matrimonios Marriages		Divorcios Divorces	
		Número	Tasa 1/	Número	Tasa 1/	Número	Tasa 2/	Número	Tasa 3/	Número	Tasa 2/	Número	Tasa 1/	Número	Tasa 1/
1999	3,886,425	59,684	15.4	29,145	7.5	632	10.6	11	18.4	684	11.5	27,255	9.3	15,527	5.3
1998	3,833,482	60,518	15.8	29,990	7.8	637	10.5	4	6.6	692	11.4	26,760	9.3	13,832	4.8
1997	3,805,003	64,214	16.9	29,119	7.7	729	11.4	10	15.6	740	11.7	31,480	11.0	13,737	4.8
1996	3,733,326	63,259	17.0	29,871	8.0	665	10.5	11	17.4	708	11.1	32,572	11.7	13,172	4.7
1995	3,719,317	63,518	17.0	30,196	8.1	809	12.7	9	14.2	650	10.1	32,514	11.7	13,648	4.9
1994	3,685,729	64,325	17.4	28,444	7.7	738	11.5	5	7.7	646	9.9	33,200	12.3	13,724	5.1
1993	3,621,538	65,242	18.0	28,494	7.9	874	13.4	9	13.8	734	11.1	33,262	12.6	14,198	5.4
1992	3,578,980	64,481	18.0	27,397	7.7	822	12.7	14	21.7	649	10.0	34,222	9.6	14,227	5.5
1991	3,549,160	64,516	18.2	26,328	7.4	841	13.0	13	20.2	631	9.7	33,222	12.9	13,571	5.3
1990	3,527,796	66,555	18.9	26,148	7.4	893	13.4	13	19.5	666	9.9	33,080	12.9	13,695	5.3
1989	3,497,287	66,692	19.1	25,987	7.4	952	14.3	13	19.5	620	9.2	31,642	12.5	13,838	5.5
1988	3,461,385	64,081	18.5	25,123	7.3	810	12.6	11	17.2	647	10.0	32,214	12.9	13,930	5.6
1987	3,433,345	64,393	18.8	23,954	7.0	916	14.2	11	17.1	626	9.6	33,285	13.6	14,611	6.0
1986	3,406,229	63,551	18.7	23,387	6.9	873	13.7	10	15.7	642	10.5	32,335	13.4	13,554	5.6
1985	3,378,126	63,629	18.8	23,194	6.9	947	14.9	8	12.6	657	10.2	30,306	12.7	14,686	6.2
1984	3,348,754	63,321	18.9	21,733	6.5	991	15.7	6	9.5	673	10.5	29,695	12.3	13,698	5.7
1983	3,321,848	65,742	19.8	21,499	6.5	1,140	17.3	4	6.1	710	10.7	29,632	12.8	13,164	5.7
1982	3,290,435	69,336	21.1	21,522	6.5	1,193	17.2	8	11.5	757	10.8	30,385	13.3	14,084	6.2
1981	3,251,847	71,365	21.9	21,197	6.5	1,325	18.6	12	16.8	775	10.7	31,916	14.3	14,247	6.4
1980	3,203,956	73,060	22.8	20,486	6.4	1,386	19.0	6	8.2	820	11.1	33,167	15.1	15,276	6.9
1979	3,160,700	73,781	23.3	20,390	6.5	1,469	19.9	8	10.8	854	11.6	33,768	15.7	14,791	6.9
1978	3,121,600	75,066	24.0	19,876	6.4	1,390	18.5	4	5.3	950	12.7	33,253	16.0	14,753	7.1
1977	3,074,100	75,151	24.4	19,895	6.5	1,507	20.1	10	13.3	1,007	13.4	34,541	16.9	12,085	5.9
1976	3,018,300	72,883	24.1	19,893	6.6	1,472	20.2	9	12.3	1,035	14.2	33,741	17.1	12,357	6.3
1975	2,938,800	69,691	23.7	19,073	6.5	1,455	20.9	11	15.8	1,047	15.0	32,731	17.2	12,905	6.8
1974	2,890,000	70,082	24.2	19,490	6.7	1,609	23.0	19	27.1	1,100	15.7	33,410	17.9	11,688	6.3
1973	2,872,300	68,821	24.0	19,257	6.7	1,667	24.2	9	13.1	1,158	16.8	34,221	18.5	12,593	6.8
1972	2,865,100	68,914	24.1	19,011	6.6	1,866	27.1	27	39.2	1,219	17.7	33,555	18.2	13,269	7.2
1971	2,779,300	71,117	25.6	18,144	6.5	1,957	27.5	20	28.1	1,280	18.0	32,069	18.4	10,770	6.2
1970	2,716,000	67,438	24.8	18,080	6.7	1,930	28.6	18	26.7	1,276	18.9	29,653	10.9	9,713	3.6
1969	2,706,000	67,577	25.0	17,669	6.5	2,005	29.7	24	35.5	1,367	20.2	29,741	11.0	9,509	3.5
1968	2,665,000	67,989	25.5	17,481	6.6	1,986	29.2	12	17.6	1,394	20.5	29,036	10.9	8,929	3.4
1967	2,634,000	70,755	26.9	16,780	6.4	2,317	32.7	26	36.7	1,673	23.6	26,406	10.0	7,728	2.9
1966	2,612,000	75,735	29.0	17,506	6.7	2,850	37.6	34	44.9	1,798	23.7	25,542	9.8	7,517	2.9
1965	2,583,000	79,586	30.8	17,719	6.9	3,421	43.0	40	50.3	2,072	26.0	25,184	9.7	8,035	3.1
1964	2,542,000	78,837	31.0	18,556	7.3	4,074	51.7	46	58.3	2,132	27.0	23,773	9.4	7,460	2.9
1963	2,491,000	77,382	31.1	17,386	7.0	3,467	44.8	42	54.3	2,186	28.2	23,465	9.4	6,309	2.5
1962	2,447,000	76,677	31.3	16,575	6.8	2,192	28.6	58	75.6	2,187	28.5	22,883	9.4	6,565	2.7
1961	2,402,000	75,563	31.5	16,361	6.8	3,193	42.3	44	58.2	2,202	29.1	21,440	8.9	5,697	2.4
1960	2,360,000	76,015	32.2	15,841	6.7	3,325	43.7	38	50.0	2,276	29.9	20,580	8.7	5,386	2.3

\* Población al 1ro de julio. 1/ Tasa por 1,000 habitantes. - Rates per 1,000 inhabitants. 2/ Tasas por 1,000 nacidos vivos. - Rates per 1,000 live births.

3/ Tasa por 100,000 nacidos vivos. - Rates per 100,000 live births.

Fuente: Departamento de Salud, SAPEESI, División de Estadísticas, San Juan, PR.

**Gráfica 1**  
**TASAS\* DE NATALIDAD Y MORTALIDAD POR AÑOS**  
**PUERTO RICO, 1960 - 1999**

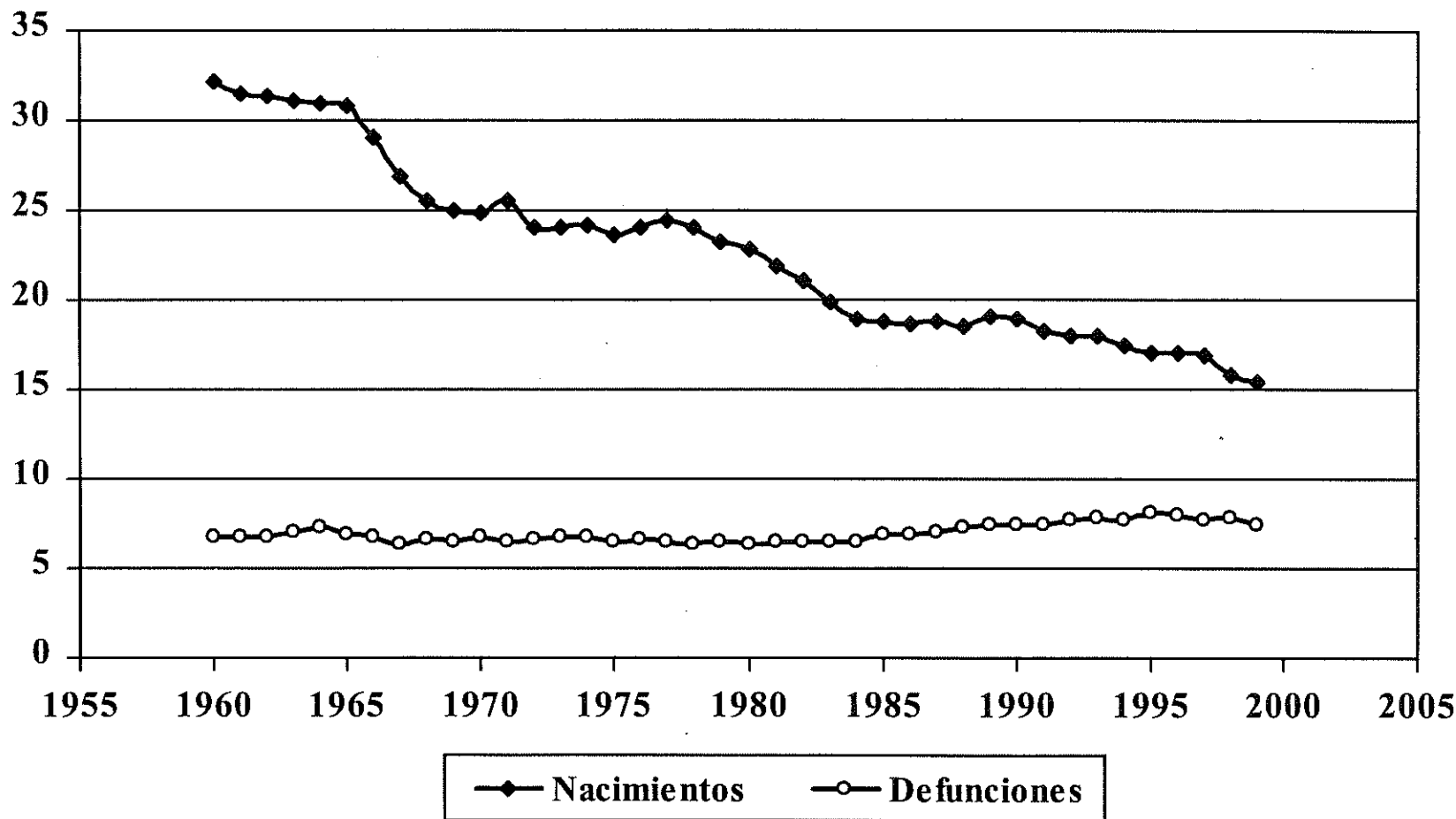

\* TASAS POR 1,000 HABITANTES RATES PER 1,000 POPULATION  
 FUENTE: DEPARTAMENTO DE SALUD, SAPEESI, DIVISION DE ESTADISTICAS, SAN JUAN, PUERTO RICO  
 SOURCE: DEPARTMENT OF HEALTH, ASPESIS, DIVISION OF STATISTICS, SAN JUAN, PUERTO RICO

Tabla 2 - ESTADISTICAS DEMOGRAFICAS POR REGIONES , AREAS DE SALUD Y MUNICIPIO  
 Table 2 - DEMOGRAPHIC STATISTICS BY REGIONS,HEALTH AREAS AND MUNICIPALITY  
 PUERTO RICO, 1999

Pag 1 de 4

MUNICIPIOS MUNICIPALITIES	1	2		2		3		4		3		5	
	POBLACION POPULATION	NACIMIENTOS VIVOS LIVE BIRTHS		DEFUNCIONES DEATHS		MUERTES INFANTILES INFANT DEATHS		MUERTE MATERNA MATERNAL DEATH		MORTINATOS STILLBIRTHS		MATRIMONIOS MARRIAGES	
		NUM. NO.	TASA RATE	NUM. NO.	TASA RATE	NUM. NO.	TASA RATE	NUM. NO.	TASA RATE	NUM. NO.	TASA RATE	NUM. NO.	TASA RATE
<b>TOTAL</b>	<b>3,866,426</b>	<b>59,684</b>	<b>15.4</b>	<b>29,145</b>	<b>7.5</b>	<b>632</b>	<b>10.6</b>	<b>11</b>	<b>18.4</b>	<b>660</b>	<b>10.8</b>	<b>27,255</b>	<b>7.1</b>
REGION ARECIBO	464,307	7,333	15.8	3,590	7.7	76	10.4	1	13.6	63	8.4	3,543	7.7
AREA DE ARECIBO	269,430	3,927	14.6	2,110	7.8	41	10.4	1	25.5	36	8.6	2,159	8
ARECIBO	101,701	1,454	14.3	924	9.1	20	13.8	-	-	36	22.7	779	7.6
CAMUY	33,045	537	16.3	213	6.4	5	9.3	1	186.2	-	-	288	8.7
HATILLO	40,656	547	13.5	291	7.2	5	9.1	-	-	-	-	328	8.2
LARES	32,821	520	15.8	222	6.8	4	7.7	-	-	-	-	255	7.9
QUEBRADILLAS	25,942	393	15.1	164	6.3	-	-	-	-	-	-	234	8.8
UTUADO	35,265	476	13.5	296	8.4	7	14.7	-	-	-	-	275	7.7
AREA DE MANATI	194,877	3,406	17.5	1,480	7.6	35	10.3	-	-	27	8	1,384	7.3
BARCELONETA	27,361	357	13	186	6.8	4	11.2	-	-	-	-	151	5.7
CIALES	20,864	361	17.3	172	8.2	6	16.6	-	-	-	-	163	8.3
FLORIDA	9,054	200	22.1	88	9.7	1	5	-	-	-	-	141	15.7
MANATI	41,821	827	19.8	343	8.2	9	10.9	-	-	26	32.4	376	9.2
MOROVIS	33,812	587	17.4	183	5.4	4	6.8	-	-	-	-	135	4.1
VEGA BAJA	61,965	1,074	17.3	508	8.2	11	10.2	-	-	1	0.9	418	6.7
REGION BAYAMON	635,115	10,048	15.8	4,186	6.6	96	9.6	-	-	89	8.7	3,915	6.2
AREA BARRANQUITAS	140,002	2,199	15.7	910	6.5	23	10.5	-	-	-	-	804	5.7
BARRANQUITAS	28,859	470	16.3	206	7.1	2	4.3	-	-	-	-	204	7.1
COMERIO	20,461	258	12.6	143	7	3	11.6	-	-	-	-	96	4.5
COROZAL	36,581	546	14.9	222	6.1	6	11	-	-	-	-	231	6.3
NARANJITO	29,098	495	17	193	6.6	8	16.2	-	-	-	-	156	5.3
OROCOVIS	25,003	430	17.2	146	5.8	4	9.3	-	-	-	-	117	4.7
AREA DE BAYAMON	333,801	5,259	15.8	2,249	6.7	49	9.3	-	-	88	16.8	2,215	6.7
BAYAMON	235,253	3,574	15.2	1,720	7.3	38	10.6	-	-	88	24.6	1,628	7
TOA ALTA	61,219	1,049	17.1	283	4.6	4	3.8	-	-	-	-	309	5.1
VEGA ALTA	37,329	636	17	246	6.6	7	11	-	-	-	-	278	7.7
AREA DE CATANO	161,312	2,590	16.1	1,027	6.4	24	9.3	-	-	1	0.4	896	5.6
CATANO	32,183	513	15.9	241	7.5	6	11.7	-	-	-	-	197	6.1
DORADO	34,863	593	17	240	6.9	2	3.4	-	-	1	1.7	263	7.9
TOA BAJA	94,266	1,484	15.7	546	5.8	16	10.8	-	-	-	-	436	4.6



Tabla 2 - ESTADISTICAS DEMOGRAFICAS POR REGIONES , AREAS DE SALUD Y MUNICIPIO  
 Table 2 - DEMOGRAPHIC STATISTICS BY REGIONS,HEALTH AREAS AND MUNICIPALITY  
 PUERTO RICO, 1999

Pag 2 de 4

MUNICIPIOS  MUNICIPALITIES	1	2		2		3		4		3		5	
	POBLACION  POPULATION	NACIMIENTOS VIVOS LIVE BIRTHS		DEFUNCIONES  DEATHS		MUERTES INFANTILES INFANT DEATHS		MUERTE MATERNA MATERNAL DEATH		MORTINATOS  STILLBIRTHS		MATRIMONIOS  MARRIAGES	
		NUM. NO.	TASA RATE	NUM. NO.	TASA RATE	NUM. NO.	TASA RATE	NUM. NO.	TASA RATE	NUM. NO.	TASA RATE	NUM. NO.	TASA RATE
REGION DE CAGUAS	591,871	8,879	15	4,126	7	98	11	1	11.3	81	8.8	4,149	7.1
AREA DE CAGUAS	291,369	4,530	15.5	2,143	7.4	56	12.4	-	-	46	10.1	1,967	6.9
AGUAS BUENAS	31,650	493	15.6	213	6.7	5	10.1	-	-	-	-	188	6.1
CAGUAS	144,350	2,262	15.7	1,139	7.9	30	13.3	-	-	46	19.9	1,064	7.5
GURABO	33,810	574	17	226	6.7	6	10.5	-	-	-	-	255	7.6
JUNCOS	43,325	577	13.3	261	6	8	13.9	-	-	-	-	229	5.4
SAN LORENZO	38,234	624	16.3	304	8	7	11.2	-	-	-	-	231	6.2
AREA DE CAYEY	128,354	1,736	13.5	803	6.3	22	12.7	-	-	14	7.1	589	4.5
AIBONITO	27,828	386	13.9	193	6.9	3	7.8	-	-	9	18.5	192	6.8
CAYEY	50,822	739	14.5	387	7.6	12	16.2	-	-	5	6.2	326	6.3
CIDRA	49,704	611	12.3	223	4.5	7	11.5	-	-	-	-	263	5.3
AREA DE HUMACAO	172,148	2,613	15.2	1,180	6.9	20	7.7	1	38.3	21	7.9	1,401	8.2
HUMACAO	59,698	935	15.7	414	6.9	5	5.3	-	-	21	21.8	572	9.8
LAS PIEDRAS	31,943	529	16.6	209	6.5	7	13.2	-	-	-	-	269	8.4
MAUNABO	13,788	185	13.4	90	6.5	2	10.8	-	-	-	-	92	6.9
NAGUABO	25,226	370	14.7	201	8	2	5.4	-	-	-	-	188	7.5
YABUCOA	41,493	594	14.3	266	6.4	4	6.7	1	168.4	-	-	280	6.7
REGION MAYAGUEZ	315,428	4,578	14.5	2,580	8.2	50	10.9	2	43.7	45	9.6	2,233	4.1
AREA DE MAYAGUEZ	224,447	3,167	14.1	1,826	8.1	31	9.8	1	31.6	36	10.9	1,641	7.3
ANASCO	28,389	424	14.9	213	7.5	6	14.2	-	-	-	-	210	7.5
CABO ROJO	49,082	673	13.7	412	8.4	7	10.4	1	148.6	-	-	336	6.9
HORMIGUEROS	16,971	213	12.6	125	7.4	2	9.4	-	-	-	-	134	7.8
LAS MARIAS	9,828	139	14.1	67	6.8	-	-	-	-	-	-	68	6.9
MARICAO	6,096	107	17.6	33	5.4	2	18.7	-	-	-	-	33	5.4
MAYAGUEZ	99,849	1,366	13.7	863	8.6	14	10.2	-	-	36	23.7	741	7.3
RINCON	14,232	245	17.2	113	7.9	-	-	-	-	-	-	119	8.7
AREA DE SAN GERMAN	90,981	1,411	15.5	754	8.3	19	13.5	1	70.9	9	6.6	592	6.7
LAJAS	27,631	372	13.5	209	7.6	4	10.8	-	-	-	-	154	5.7
SABANA GRANDE	24,767	423	17.1	217	8.8	4	9.5	-	-	-	-	130	5.4
SAN GERMAN	38,583	616	16	328	8.5	11	17.9	1	162.3	9	16.6	308	8.3

Tabla 2 - ESTADISTICAS DEMOGRAFICAS POR REGIONES , AREAS DE SALUD Y MUNICIPIO  
 Table 2 - DEMOGRAPHIC STATISTICS BY REGIONS,HEALTH AREAS AND MUNICIPALITY  
 PUERTO RICO, 1999

Pag 3 de 4

MUNICIPIOS MUNICIPALITIES	1 POBLACION POPULATION	2 NACIMIENTOS VIVOS LIVE BIRTHS		2 DEFUNCIONES DEATHS		3 MUERTES INFANTILES INFANT DEATHS		4 MUERTE MATERNA MATERNAL DEATH		3 MORTINATOS STILLBIRTHS		5 MATRIMONIOS MARRIAGES	
		NUM. NO.	TASA RATE	NUM. NO.	TASA RATE	NUM. NO.	TASA RATE	NUM. NO.	TASA RATE	NUM. NO.	TASA RATE	NUM. NO.	TASA RATE
		SUB REGION AGUADILLA	231,086	3,449	14.9	1,742	7.5	25	7.2	-	-	36	10.5
AGUADA	39,774	624	15.7	281	7.1	5	8	-	-	-	-	303	7.8
AGUADILLA	66,655	902	13.5	522	7.8	6	6.7	-	-	17	18.7	551	8.4
ISABELA	42,867	619	14.4	354	8.3	3	4.8	-	-	1	1.6	345	8.3
MOCA	38,198	672	17.6	241	6.3	5	7.4	-	-	17	25.8	318	8.5
SAN SEBASTIAN	43,592	632	14.5	344	7.9	6	9.5	-	-	1	1.6	341	7.8
REGION PONCE	600,585	9,936	16.5	4,616	7.7	124	12.5	3	30.2	137	13.4	4,092	6.9
AREA DE GUAYAMA	116,027	1,894	16.3	921	7.9	26	13.7	1	52.8	13	6.4	804	7
ARROYO	20,035	286	14.3	161	8	8	28	-	-	2	6.4	124	6.2
GUAYAMA	43,802	762	17.4	343	7.8	3	3.9	-	-	11	13.9	335	7.8
PATILLAS	21,770	292	13.4	159	7.3	4	13.7	1	342.5	-	-	165	7.5
SALINAS	30,420	554	18.2	258	8.5	11	19.9	-	-	-	-	180	6
AREA DE PONCE	362,639	6,205	17.1	2,794	7.7	75	12.1	2	32.2	114	18.2	2,518	7.1
ADJUNTAS	19,528	300	15.4	156	8	3	10	-	-	-	-	140	7.1
COAMO	37,102	669	18	277	7.5	10	14.9	-	-	-	-	212	5.7
JAYUYA	16,793	306	18.2	109	6.5	5	16.3	-	-	-	-	135	8.2
JUANA DIAZ	52,133	867	16.6	387	7.4	10	11.5	-	-	-	-	307	6.1
PONCE	192,483	3,069	15.9	1,579	8.2	33	10.8	-	-	114	36.2	1,432	7.5
SANTA ISABEL	20,037	451	22.5	136	6.8	5	11.1	1	221.7	-	-	120	6.1
VILLALBA	24,563	543	22.1	150	6.1	9	16.6	1	184.2	-	-	172	7.3
AREA DE YAUCO	121,919	1,837	15.1	901	7.4	23	12.5	-	-	10	5.2	770	6.3
GUANICA	21,504	330	15.3	175	8.1	4	12.1	-	-	-	-	129	5.9
GUAYANILLA	28,366	357	12.6	189	6.7	6	16.8	-	-	-	-	169	5.9
PEÑUELAS	27,036	478	17.7	158	5.8	5	10.5	-	-	-	-	141	5.2
YAUCO	45,013	672	14.9	379	8.4	8	11.9	-	-	10	13.5	331	7.5
REGION METROPOLITANA	889,809	13,034	14.6	7,088	8	139	10.7	2	15.3	206	15.3	6,252	6.1
AREA DE CAROLINA	348,440	5,123	14.7	2,242	6.4	35	6.8	2	39	28	5.4	2,169	6.3
CANOVANAS	51,614	823	15.9	310	6	4	4.9	-	-	1	1.2	340	6.6
CAROLINA	190,937	2,729	14.3	1,343	7	21	7.7	2	73.3	27	9.9	1,345	7.1
LOIZA	27,905	407	14.6	177	6.3	4	9.8	-	-	-	-	140	5
TRUJILLO ALTO	77,984	1,164	14.9	412	5.3	6	5.2	-	-	-	-	344	4.5

Tabla 2 - ESTADISTICAS DEMOGRAFICAS POR REGIONES , AREAS DE SALUD Y MUNICIPIO  
 Table 2 - DEMOGRAPHIC STATISTICS BY REGIONS, HEALTH AREAS AND MUNICIPALITY  
 PUERTO RICO, 1999

Pag 4 de 4

MUNICIPIOS MUNICIPALITIES	1 POBLACION POPULATION	2 NACIMIENTOS VIVOS LIVE BIRTHS		2 DEFUNCIONES DEATHS		3 MUERTES INFANTILES INFANT DEATHS		4 MUERTE MATERNA MATERNAL DEATH		3 MORTINATOS STILLBIRTHS		5 MATRIMONIOS MARRIAGES	
		NUM. NO.	TASA RATE	NUM. NO.	TASA RATE	NUM. NO.	TASA RATE	NUM. NO.	TASA RATE	NUM. NO.	TASA RATE	NUM. NO.	TASA RATE
		AREA DE SAN JUAN	541,369	7,911	14.6	4,846	9	104	13.1	-	-	178	21.4
GUAYNABO	104,303	1,471	14.1	712	6.8	13	8.8	-	-	-	-	668	6.4
SAN JUAN	437,066	6,440	14.7	4,134	9.5	91	14.1	-	-	178	26.5	3,415	7.8
SUB REGION FAJARDO	138,225	2,306	16.7	1,029	7.4	20	8.7	2	86.7	3	1.3	1,213	8.9
CEIBA	18,835	278	14.8	105	5.6	2	7.2	1	359.7	-	-	156	8.5
CULEBRA	1,760	16	9.1	16	9.1	-	-	-	-	-	-	12	7.2
FAJARDO	38,376	690	18	308	8	4	5.8	-	-	3	4.2	418	10.9
LUQUILLO	18,765	337	18	152	8.1	4	11.9	-	-	-	-	176	9.4
RIO GRANDE	50,961	838	16.4	363	7.1	10	11.9	1	119.3	-	-	392	7.8
VIEQUES	9,528	147	15.4	85	8.9	-	-	-	-	-	-	59	6.5
P R NO ESPECIFICADO	-	-	-	-	-	-	-	-	-	-	-	-	-
DESCONOCIDO	-	24	-	8	-	1	41.7	-	-	-	-	-	-
OTROS PAISES	-	97	-	180	-	3	30.9	-	-	-	-	-	-

(1) POBLACION AL 1RO. DE JULIO 1999 - POPULATION AS OF JULY 1ST. 1999.  
 NACIMIENTOS, DEFUNCIONES, MUERTES INFANTILES Y MORTINATOS POR MUNICIPIO DE RESIDENCIA - LIVE BIRTHS, DEATHS, INFANT DEATHS,  
 STILLBIRTHS BY MUNICIPALITY OF RESIDENCE.  
 MATRIMONIOS POR MUNICIPIO DE OCURRENCIA - MARRIAGES BY MUNICIPALITY OF OCCURRENCE.

(2) TASAS POR 1,000 HABITANTES - RATES PER 1,000 POPULATION.  
 (3) TASAS POR 1,000 NACIDOS VIVOS - RATES PER 1,000 LIVE BIRTHS.  
 (4) TASAS POR 100,000 NACIDOS VIVOS - RATES PER 100,000 LIVE BIRTHS.  
 (5) TASAS POR 1,000 HABITANTES DE 15 AÑOS O MAS - RATES PER 1,000 POPULATION FROM FIFTEEN YEARS OR MORE  
 FUENTE: DEPARTAMENTO DE SALUD, SAPEESI, DIVISION DE ESTADISTICAS, SAN JUAN, PUERTO RICO  
 SOURCE: DEPARTMENT OF HEALTH, ASPESIS, DIVISION OF STATISTICS, SAN JUAN, PUERTO RICO



Tabla 3 - PERFIL DE LOS NACIMIENTOS EN HOSPITALES PUBLICOS Y PRIVADOS  
 Table 3 - PROFILE OF LIVE BIRTHS BY TYPE OF MEDICAL FACILITY  
 PUERTO RICO, 1999

CARACTERISTICAS SOBRESALIENTES IMPORTANT CHARACTERISTICS	TIPO DE HOSPITAL - TYPE OF MEDICAL FACILITY							
	TOTAL		PUBLICO		PRIVADO		OTROS LUGARES	
	Número	Por ciento	Número	Por ciento	Número	Por ciento	Número	Por ciento
TOTAL DE NACIMIENTOS OCURRIDOS TOTAL BIRTHS	59,684	100	20,231	33.9	39,315	65.87	138	0.23
EDAD DE LA MADRE - MOTHER'S AGE								
MADRES ADOLESCENTES (<20) TEENAGE MOTHERS	11,783	19.74	5,730	48.63	6,032	51.19	21	0.18
MADRES MENORES DE 25 AÑOS MOTHERS < 25	19,098	32	7,110	37.23	11,941	62.52	47	0.25
MADRES DE 25 A 29 AÑOS MOTHERS FROM 25 TO 29	15,111	25.32	4,016	26.58	11,065	73.22	30	0.25
MADRES DE 30 AÑOS O MAS MOTHERS > 30	13,645	22.86	3,350	24.55	10,257	75.17	38	0.28
DESCONOCIDO UNSPECIFIED	47	0.08	25	53.19	20	42.55	2	4.26
NACIMIENTOS BAJO PESO LOW BIRTH WEIGHT BABIES	6,810	11.41	2,952	43.35	3,821	56.11	37	0.54
TRIMESTRE COMENZO CUIDADO PRENATAL - TRIMESTER PRENATAL CARE BEGAN								
1ER TRIMESTRE - 1ST TRIMESTER	46,179	77.37	14,154	30.65	31,965	69.22	60	0.13
2DO TRIMESTRE - 2NO TRIMESTER	11,081	18.57	4,853	43.8	6,190	55.86	38	0.34
3ER TRIMESTRE - 3RD TRIMESTER	1,620	2.71	692	42.72	924	57.04	4	0.25
NAC. SIN CUIDADO PRENATAL NO PRENATAL CARE	566	0.95	460	81.27	78	13.78	28	4.95
DESCONOCIDO - UNSPECIFIED	238	0.4	72	30.25	158	66.39	8	3.36
ESCOLARIDAD DE LA MADRE - MOTHER'S EDUCATION								
MENOS DE 12 AÑOS DE ESCUELA LESS THAN 12 YEARS	16,038	26.87	8,792	54.82	7,183	44.79	63	0.39
12 AÑOS DE ESCUELA 12 YEARS	17,361	29.09	6,548	37.72	10,779	62.09	34	0.2
13 A 15 AÑOS DE ESCUELA 13 TO 15 YEARS	13,676	22.91	3,365	24.61	10,294	75.27	17	0.12
16 AÑOS DE ESCUELA O MAS 16 YEARS OR MORE	12,366	20.72	1,423	11.51	10,924	88.34	19	0.15
DESCONOCIDO UNSPECIFIED	243	0.41	103	42.39	135	55.56	5	2.06
NACIMIENTOS A MADRES SOLTERAS BIRTHS TO UNMARRIED MOTHERS	28,720	48.12	12,939	45.05	15,673	54.57	108	0.38

FUENTE: DEPARTAMENTO DE SALUD, SAPEESI, DIVISION DE ESTADISTICAS, SAN JUAN, PR.

SOURCE: DEPARTMENT OF HEALTH, ASPESIS, DIVISION OF STATISTICS, SAN JUAN, PR.

**Gráfica 2**  
**NACIMIENTOS VIVOS POR EDAD DE LA MADRE**  
**PUERTO RICO, 1999**

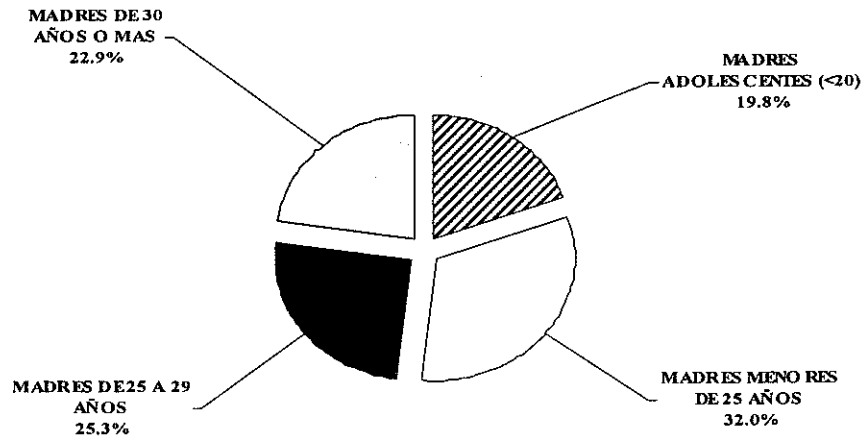

FUENTE: DEPARTAMENTO DE SALUD, SAPEESI, DIVISION DE ESTADISTICAS, SAN JUAN, PUERTO RICO  
 SOURCE: DEPARTMENT OF HEALTH, ASPEESI, DIVISION OF STATISTICS, SAN JUAN, PUERTO RICO

**Gráfica 3**  
**NACIMIENTOS VIVOS POR TIPO DE HOSPITAL**  
**PUERTO RICO, 1999**

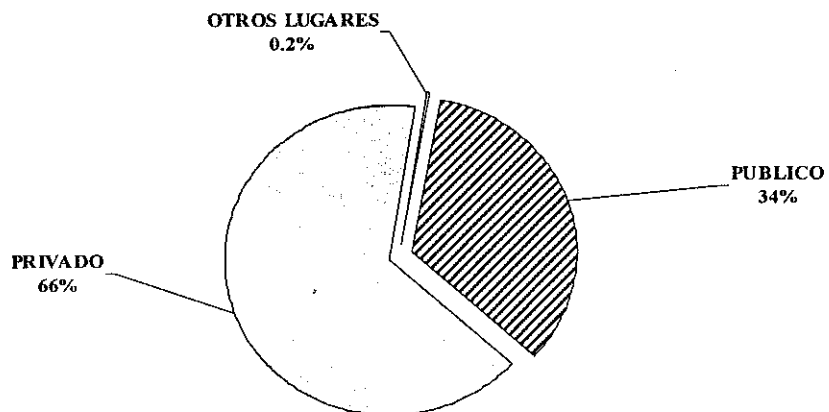

FUENTE: DEPARTAMENTO DE SALUD, SAPEESI, DIVISION DE ESTADISTICAS, SAN JUAN, PUERTO RICO  
 SOURCE: DEPARTMENT OF HEALTH, ASPEESI, DIVISION OF STATISTICS, SAN JUAN, PUERTO RICO

**Gráfica 4**  
**NACIMIENTOS VIVOS POR TRIMESTRE EN**  
**QUE COMENZO CUIDADO PRENATAL**  
**PUERTO RICO, 1999**

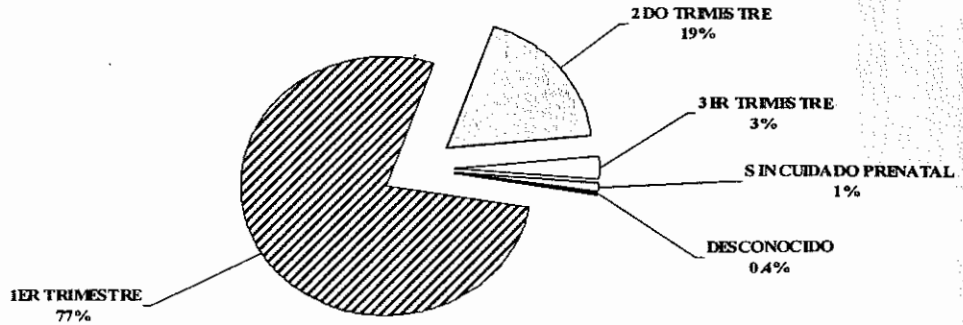

FUENTE: DEPARTAMENTO DE SALUD, SAPEESI, DIVISION DE ESTADISTICAS, SAN JUAN, PUERTO RICO  
 SOURCE: DEPARTMENT OF HEALTH, ASPESIS, DIVISION OF STATISTICS, SAN JUAN, PUERTO RICO

**Gráfica 5**  
**NACIMIENTOS VIVOS POR ESCOLARIDAD DE LA MADRE**  
**PUERTO RICO, 1999**

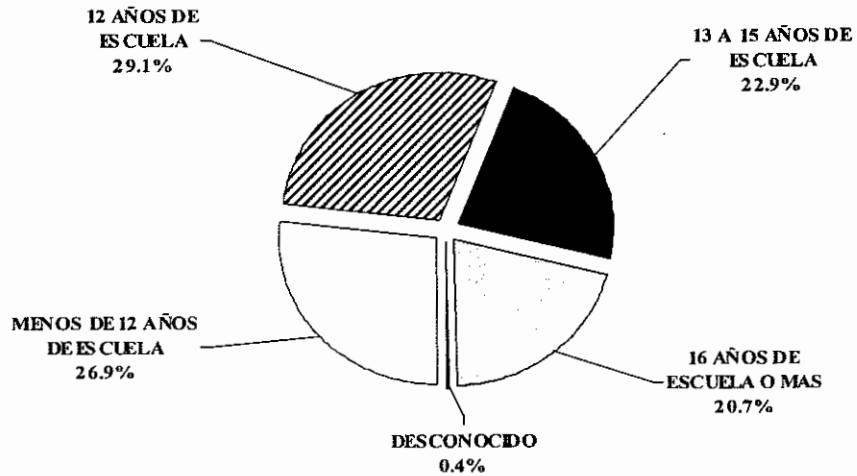

FUENTE: DEPARTAMENTO DE SALUD, SAPEESI, DIVISION DE ESTADISTICAS, SAN JUAN, PUERTO RICO  
 SOURCE: DEPARTMENT OF HEALTH, ASPESIS, DIVISION OF STATISTICS, SAN JUAN, PUERTO RICO



Tabla 4 - NACIMIENTOS VIVOS POR MUNICIPIO DE RESIDENCIA DE LA MADRE (BAJO PESO, ADOLESCENTES, SOLTERAS Y CUIDADO PRENATAL TEMPRANO)  
 Table 4 - LIVE BIRTHS BY MUNICIPALITY OF MOTHER'S RESIDENCE (LOW BIRTH WEIGHT, TEENAGE MOTHERS, ILLEGITIMATE AND EARLY PRENATAL CARE)  
 PUERTO RICO, 1999

Pag 1 de 3

REGION Y/O MUNICIPIO RESIDENCIA	TOTAL NAC. VIVOS	MUY BAJO PESO <1,500 GR O <3LB 5OZ		BAJO PESO <2,500 GR O <5LB 9OZ		MADRES ADOLESCENTES 10 A 19 AÑOS		MADRES SOLTERAS Y/O CONSENSUAL		CUIDADO PRENATAL PRIMER TRIMESTRE	
		NUMERO	POR CIENTO	NUMERO	POR CIENTO	NUMERO	POR CIENTO	NUMERO	POR CIENTO	NUMERO	POR CIENTO
<b>TOTAL</b>	<b>59,684</b>	<b>797</b>	<b>1.3</b>	<b>6,810</b>	<b>11.4</b>	<b>11,783</b>	<b>19.7</b>	<b>28,720</b>	<b>48.1</b>	<b>46,179</b>	<b>77.4</b>
<b>REGION ARECIBO</b>	<b>7,333</b>	<b>92</b>	<b>1.3</b>	<b>883</b>	<b>12</b>	<b>1,529</b>	<b>20.9</b>	<b>3,122</b>	<b>42.6</b>	<b>6,257</b>	<b>85.3</b>
AREA DE ARECIBO	3,927	49	1.2	516	13.1	798	20.3	1,460	37.2	3,377	86
ARECIBO	1,454	15	1	181	12.4	270	18.6	584	40.2	1,316	90.5
CAMUY	537	8	1.5	75	14	97	18.1	154	28.7	480	89.4
HATILLO	547	5	0.9	62	11.3	112	20.5	168	30.7	449	82.1
LARES	520	6	1.2	66	12.7	128	24.6	211	40.6	424	81.5
QUEBRADILLAS	393	6	1.5	62	15.8	102	26	141	35.9	317	80.7
UTUADO	476	9	1.9	70	14.7	89	18.7	202	42.4	391	82.1
AREA DE MANATI	3,406	43	1.3	367	10.8	731	21.5	1,662	48.8	2,880	84.6
BARCELONETA	357	5	1.4	25	7	57	16	160	44.8	310	86.8
CIALES	361	7	1.9	36	10	93	25.8	192	53.2	312	86.4
FLORIDA	200	0	0	11	5.5	38	19	76	38	172	86
MANATI	827	8	1	77	9.3	162	19.6	380	45.9	675	81.6
MOROVIS	587	5	0.9	87	14.8	147	25	332	56.6	537	91.5
VEGA BAJA	1,074	18	1.7	131	12.2	234	21.8	522	48.6	874	81.4
<b>REGION BAYAMON</b>	<b>10,048</b>	<b>134</b>	<b>1.3</b>	<b>1,200</b>	<b>11.9</b>	<b>1,944</b>	<b>19.3</b>	<b>5,106</b>	<b>50.8</b>	<b>7,635</b>	<b>76</b>
AREA BARRANQUITAS	2,199	16	0.7	236	10.7	541	24.6	1,262	57.4	1,832	83.3
BARRANQUITAS	470	3	0.6	43	9.1	123	26.2	289	61.5	403	85.7
COMERIO	258	2	0.8	31	12	77	29.8	164	63.6	213	82.6
COROZAL	546	5	0.9	61	11.2	126	23.1	279	51.1	482	88.3
NARANJITO	495	5	1	51	10.3	110	22.2	255	51.5	398	80.4
OROCOVIS	430	1	0.2	50	11.6	105	24.4	275	64	336	78.1
AREA DE BAYAMON	5,259	78	1.5	653	12.4	861	16.4	2,439	46.4	3,986	75.8
BAYAMON	3,574	63	1.8	484	13.5	557	15.6	1,691	47.3	2,621	73.3
TOA ALTA	1,049	5	0.5	92	8.8	146	13.9	409	39	809	77.1
VEGA ALTA	636	10	1.6	77	12.1	158	24.8	339	53.3	556	87.4
AREA DE CATAÑO	2,590	40	1.5	311	12	542	20.9	1,405	54.2	1,817	70.2
CATAÑO	513	13	2.5	69	13.5	144	28.1	356	69.4	286	55.8
DORADO	593	2	0.3	64	10.8	128	21.6	289	48.7	457	77.1
TOA BAJA	1,484	25	1.7	178	12	270	18.2	760	51.2	1,074	72.4
<b>REGION CAGUAS</b>	<b>8,879</b>	<b>119</b>	<b>1.3</b>	<b>1,008</b>	<b>11.4</b>	<b>1,784</b>	<b>20.1</b>	<b>4,414</b>	<b>49.7</b>	<b>6,956</b>	<b>78.3</b>
AREA DE CAGUAS	4,530	73	1.6	580	12.8	906	20	2,207	48.7	3,531	77.9
AGUAS BUENAS	493	7	1.4	41	8.3	111	22.5	234	47.5	350	71
CAGUAS	2,262	40	1.8	326	14.4	424	18.7	1,119	49.5	1,810	80
GURABO	574	12	2.1	71	12.4	107	18.6	250	43.6	461	80.3
JUNCOS	577	8	1.4	67	11.6	130	22.5	291	50.4	400	69.3
SAN LORENZO	624	6	1	75	12	134	21.5	313	50.2	510	81.7

Tabla 4 - NACIMIENTOS VIVOS POR MUNICIPIO DE RESIDENCIA DE LA MADRE (BAJO PESO, ADOLESCENTES, SOLTERAS Y CUIDADO PRENATAL TEMPRANO)  
 Table 4 - LIVE BIRTHS BY MUNICIPALITY OF MOTHER'S RESIDENCE (LOW BIRTH WEIGHT, TEENAGE MOTHERS, ILLEGITIMATE AND EARLY PRENATAL CARE)  
 PUERTO RICO, 1999

Pag 2 de 3

REGION Y/O MUNICIPIO RESIDENCIA	TOTAL NAC. VIVOS	MUY BAJO PESO <1,500 GR O <3LB 5OZ		BAJO PESO <2,500 GR O <5LB 9OZ		MADRES ADOLESCENTES 10 A 19 AÑOS		MADRES SOLTERAS Y/O CONSENSUAL		CUIDADO PRENATAL PRIMER TRIMESTRE	
		NUMERO	POR CIENTO	NUMERO	POR CIENTO	NUMERO	POR CIENTO	NUMERO	POR CIENTO	NUMERO	POR CIENTO
AREA DE CAYEY	1,736	20	1.2	188	10.8	349	20.1	926	53.3	1,314	75.7
AIBONITO	386	6	1.6	51	13.2	84	21.8	213	55.2	317	82.1
CAYEY	739	6	0.8	71	9.6	141	19.1	409	55.3	521	70.5
CIDRA	611	8	1.3	66	10.8	124	20.3	304	49.8	476	77.9
AREA DE HUMACAO	2,613	26	1	240	9.2	529	20.2	1,281	49	2,111	80.8
HUMACAO	935	7	0.7	76	8.1	182	19.5	463	49.5	737	78.8
LAS PIEDRAS	529	5	0.9	43	8.1	96	18.1	230	43.5	449	84.9
MAUNABO	185	3	1.6	16	8.6	49	26.5	105	56.8	161	87
NAGUABO	370	6	1.6	34	9.2	66	17.8	166	44.9	284	76.8
YABUCOA	594	5	0.8	71	12	136	22.9	317	53.4	480	80.8
<b>REGION MAYAGUEZ</b>	<b>4,578</b>	<b>65</b>	<b>1.4</b>	<b>556</b>	<b>12.1</b>	<b>839</b>	<b>18.3</b>	<b>1,815</b>	<b>39.6</b>	<b>3,607</b>	<b>78.8</b>
AREA DE MAYAGUEZ	3,167	51	1.6	364	11.5	592	18.7	1,267	40	2,511	79.3
AÑASCO	424	9	2.1	51	12	80	18.9	154	36.3	347	81.8
CABO ROJO	673	8	1.2	86	12.8	117	17.4	241	35.8	544	80.8
HORMIGUEROS	213	4	1.9	14	6.6	22	10.3	71	33.3	177	83.1
LAS MARIAS	139	1	0.7	13	9.4	30	21.6	62	44.6	119	85.6
MARICAO	107	5	4.7	25	23.4	39	36.4	57	53.3	89	83.2
MAYAGUEZ	1,366	20	1.5	155	11.3	276	20.2	594	43.5	1,023	74.9
RINCON	245	4	1.6	20	8.2	28	11.4	88	35.9	212	86.5
AREA DE SAN GERMAN	1,411	14	1	192	13.6	247	17.5	548	38.8	1,096	77.7
LAJAS	372	3	0.8	42	11.3	68	18.3	148	39.8	279	75
SABANA GRANDE	423	4	0.9	59	13.9	79	18.7	171	40.4	344	81.3
SAN GERMAN	616	7	1.1	91	14.8	100	16.2	229	37.2	473	76.8
<b>SUBREGION AGUADILLA</b>	<b>3,449</b>	<b>38</b>	<b>1.1</b>	<b>382</b>	<b>11.1</b>	<b>666</b>	<b>19.3</b>	<b>1,106</b>	<b>32.1</b>	<b>3,012</b>	<b>87.3</b>
AGUADA	624	5	0.8	64	10.3	97	15.5	178	28.5	567	90.9
AGUADILLA	902	12	1.3	112	12.4	182	20.2	339	37.6	777	86.1
ISABELA	619	7	1.1	66	10.7	129	20.8	203	32.8	524	84.7
MOCA	672	7	1	75	11.2	134	19.9	179	26.6	597	88.8
SAN SEBASTIAN	632	7	1.1	65	10.3	124	19.6	207	32.8	547	86.6
<b>REGION PONCE</b>	<b>9,936</b>	<b>116</b>	<b>1.2</b>	<b>1,101</b>	<b>11.1</b>	<b>2,200</b>	<b>22.1</b>	<b>5,210</b>	<b>52.4</b>	<b>7,674</b>	<b>77.2</b>
AREA DE GUAYAMA	1,894	19	1	192	10.1	450	23.8	1,062	56.1	1,510	79.7
ARROYO	286	4	1.4	29	10.1	57	19.9	157	54.9	233	81.5
GUAYAMA	762	3	0.4	71	9.3	176	23.1	424	55.6	611	80.2
PATILLAS	292	4	1.4	28	9.6	56	19.2	141	48.3	242	82.9
SALINAS	554	8	1.4	64	11.6	161	29.1	340	61.4	424	76.5
AREA DE PONCE	6,205	81	1.3	699	11.3	1,326	21.4	3,246	52.3	4,816	77.6
ADJUNTAS	300	5	1.7	41	13.7	76	25.3	145	48.3	253	84.3

Tabla 4 - NACIMIENTOS VIVOS POR MUNICIPIO DE RESIDENCIA DE LA MADRE (BAJO PESO, ADOLESCENTES, SOLTERAS Y CUIDADO PRENATAL TEMPRANO)  
 Table 4 - LIVE BIRTHS BY MUNICIPALITY OF MOTHER'S RESIDENCE (LOW BIRTH WEIGHT, TEENAGE MOTHERS, ILLEGITIMATE AND EARLY PRENATAL CARE)  
 PUERTO RICO, 1999

Pag 3 de 3

REGION Y/O MUNICIPIO RESIDENCIA	TOTAL NAC. VIVOS	MUY BAJO PESO <1,500 GR O <3LB 5OZ		BAJO PESO <2,500 GR O <5LB 9OZ		MADRES ADOLESCENTES 10 A 19 AÑOS		MADRES SOLTERAS Y/O CONSENSUAL		CUIDADO PRENATAL PRIMER TRIMESTRE	
		NUMERO	POR CIENTO	NUMERO	POR CIENTO	NUMERO	POR CIENTO	NUMERO	POR CIENTO	NUMERO	POR CIENTO
COAMO	669	8	1.2	77	11.5	152	22.7	367	54.9	549	82.1
JAYUYA	306	1	0.3	32	10.5	77	25.2	167	54.6	232	75.8
JUANA DIAZ	867	11	1.3	72	8.3	162	18.7	426	49.1	692	79.8
PONCE	3,069	40	1.3	353	11.5	647	21.1	1,592	51.9	2,276	74.2
SANTA ISABEL	451	8	1.8	62	13.7	104	23.1	272	60.3	390	86.5
VILLALBA	543	8	1.5	62	11.4	108	19.9	277	51	424	78.1
AREA DE YAUCO	1,837	16	0.9	210	11.4	424	23.1	902	49.1	1,348	73.4
GUANICA	330	2	0.6	43	13	93	28.2	161	48.8	238	72.1
GUAYANILLA	357	5	1.4	43	12	73	20.4	167	46.8	257	72
PENUELAS	478	4	0.8	46	9.6	116	24.3	254	53.1	363	75.9
YAUCO	672	5	0.7	78	11.6	142	21.1	320	47.6	490	72.9
<b>REGION METROPOLITANA</b>	<b>13,034</b>	<b>196</b>	<b>1.5</b>	<b>1,395</b>	<b>10.7</b>	<b>2,361</b>	<b>18.1</b>	<b>6,866</b>	<b>52.7</b>	<b>9,145</b>	<b>70.2</b>
AREA DE CAROLINA	5,123	83	1.6	584	11.4	928	18.1	2,521	49.2	3,676	71.8
CANOVANAS	823	16	1.9	91	11.1	169	20.5	414	50.3	585	71.1
CAROLINA	2,729	45	1.6	316	11.6	449	16.5	1,325	48.6	1,908	69.9
LOIZA	407	7	1.7	56	13.8	128	31.4	262	64.4	300	73.7
TRUJILLO ALTO	1,164	15	1.3	121	10.4	182	15.6	520	44.7	883	75.9
AREA DE SAN JUAN	7,911	113	1.4	811	10.3	1,433	18.1	4,345	54.9	5,469	69.1
GUAYNABO	1,471	26	1.8	132	9	228	15.5	615	41.8	1,077	73.2
SAN JUAN	6,440	87	1.4	679	10.5	1,205	18.7	3,730	57.9	4,392	68.2
<b>SUBREGION FAJARDO</b>	<b>2,306</b>	<b>29</b>	<b>1.3</b>	<b>266</b>	<b>11.5</b>	<b>450</b>	<b>19.5</b>	<b>1,019</b>	<b>44.2</b>	<b>1,818</b>	<b>78.8</b>
CEIBA	278	2	0.7	26	9.4	41	14.7	94	33.8	240	86.3
CULEBRA	16	0	0	2	12.5	4	25	6	37.5	12	75
FAJARDO	690	13	1.9	74	10.7	131	19	322	46.7	563	81.6
LUQUILLO	337	4	1.2	46	13.6	78	23.1	159	47.2	261	77.4
RIO GRANDE	838	7	0.8	99	11.8	151	18	339	40.5	638	76.1
VIEQUES	147	3	2	19	12.9	45	30.6	99	67.3	104	70.7
<b>NO RESIDENTE</b>	<b>97</b>	<b>5</b>	<b>5.2</b>	<b>13</b>	<b>13.4</b>	<b>10</b>	<b>10.3</b>	<b>39</b>	<b>40.2</b>	<b>65</b>	<b>67</b>
<b>DESCONOCIDO</b>	<b>24</b>	<b>3</b>	<b>12.5</b>	<b>6</b>	<b>25</b>	<b>0</b>	<b>0</b>	<b>23</b>	<b>95.8</b>	<b>10</b>	<b>41.7</b>

FUENTE: DEPARTAMENTO DE SALUD, SAPEESI, DIVISION DE ESTADISTICAS, SAN JUAN, PUERTO RICO.

SOURCE: DEPARTMENT OF HEALTH, ASPESIS, DIVISION OF STATISTICS, SAN JUAN, PUERTO RICO.

Tabla 5 - PRIMERAS DIECINUEVE CAUSAS DE MUERTE  
Table 5 - NINETEEN LEADING CAUSES OF DEATH  
PUERTO RICO, 1999 Y 1998

CAUSAS DE MUERTE 2/	1999				1998			
	Orden	Número	Por ciento	Tasa 1/	Orden	Número	Por ciento	Tasa 1/
TODAS LAS CAUSAS	---	29145	100	753.8	---	29990	100	782.3
ENFERMEDADES DEL CORAZON(I00 -I099,I20-I519)	1	5364	18.4	138.7	1	6038	20.1	157.5
TUMORES MALIGNOS(C00 -C97 )	2	4429	15.2	114.6	2	4658	15.5	121.5
DIABETES MELLITUS(E10 -E149)	3	2184	7.5	56.5	3	2295	7.7	59.9
ENFERMEDADES HIPERTENSIVAS(I10 ,I11 -139)	4	1617	5.5	41.8	5	1395	4.7	36.4
TODOS LOS ACCIDENTES(V01 -X599,Y85 Y869)	5	1269	4.4	32.8	6	1387	4.6	36.2
ENFERMEDADES CEREBROVASCULARES(I60 -I698)	6	1266	4.3	32.7	4	1420	4.7	37.0
ENFERMEDAD PULMONAR CRONICA(J40 -J47 )	7	1240	4.3	32.1	7	1385	4.6	36.1
NEUMONIA E INFLUENZA(J10 -J189)	8	1069	3.7	27.6	8	1314	4.4	34.3
NEFRITIS Y NEFROSIS(N00 N079,N17 -N19,N25 -N279)	9	937	3.2	24.2	14	538	1.8	14.0
ENFERMEDADES DEL HIGADO Y CIRROSIS(K70-K769)	10	878	3.0	22.7	10	672	2.2	17.5
SEPTICEMIA(A40 -A419)	11	726	2.5	18.8	11	599	2.0	15.6
HOMICIDIOS E INTERVENCION LEGAL(X85 -Y099,Y871)	12	705	2.4	18.2	9	819	2.7	21.4
INFECCION VIRUS INMUNODEFICIENCIA HUMANA(B20 -B24)	13	610	2.1	15.8	13	582	1.9	15.2
ALZHEIMER(G30 -G309)	14	587	2.0	15.2	12	593	2.0	15.5
COND. ORIGINADAS EN EL PERIODO PERINATAL(P00-P969)	15	400	1.4	10.3	15	389	1.3	10.1
SUICIDIOS(X60 -X84 ,Y870)	16	299	1.0	7.7	16	324	1.1	8.5
ATEROSCLEROSIS(I70 -I709)	17	182	0.6	4.7	17	169	0.6	4.4
ANOMALIAS CONGENITAS(Q00 -Q999)	18	135	0.5	3.5	18	185	0.6	4.8
SINDROME MUERTE SUBITA INFANTIL(R95)	19	7	0.0	0.2	19	6	0.0	0.2
OTRAS CAUSAS	20	5241	18.0	135.6	---	5222	17.4	136.2

1/ TASA POR 100,000 HABITANTES.

2/ CODIFICACION SEGUN DECIMA CLASIFICACION INTERNACIONAL DE ENFERMEDADES (ICD-10).

FUENTE: DEPARTAMENTO DE SALUD, SAPEESI, DIVISION DE ESTADISTICAS, SAN JUAN, PUERTO RICO.

SOURCE: DEPARTMENT OF HEALTH, ASPESIS, DIVISION OF STATISTICS, SAN JUAN, PUERTO RICO.



**Gráfica 6**  
**PRIMERAS DIECINUEVE CAUSAS DE MORTALIDAD**  
**PUERTO RICO, 1999**



\* TASAS POR 100,000 HABITANTES RATES PER 100,000 POPULATION

FUENTE: DEPARTAMENTO DE SALUD, SAPEESI, DIVISION DE ESTADISTICAS, SAN JUAN, PUERTO RICO  
 SOURCE: DEPARTMENT OF HEALTH, ASPESIS, DIVISION OF STATISTICS, SAN JUAN, PUERTO RICO

## Mapa 2 TASAS\* DE MORTALIDAD POR MUNICIPIOS PUERTO RICO, 1999

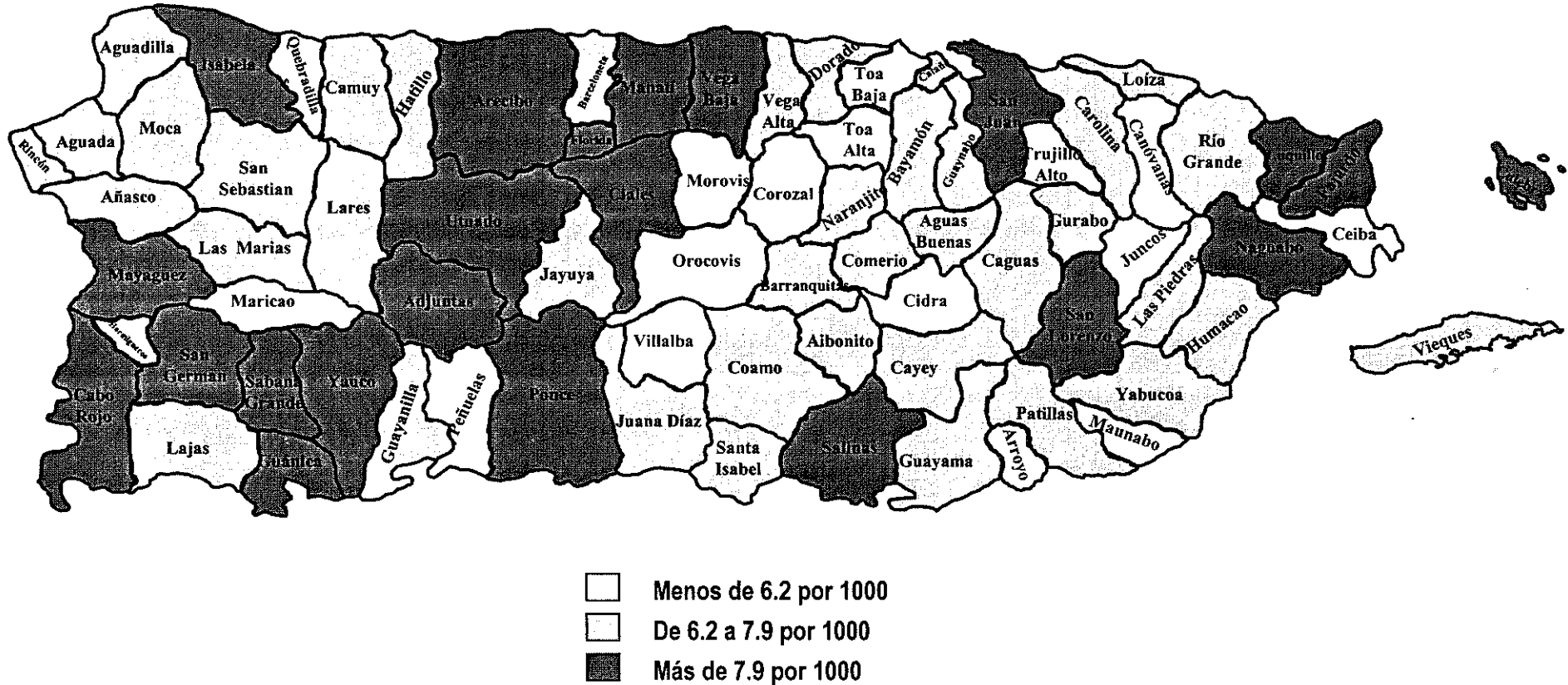

\* TASAS POR 1,000 HABITANTES RATES PER 1,000 POPULATION  
 FUENTE: DEPARTAMENTO DE SALUD, SAPEESI, DIVISION DE ESTADISTICAS, SAN JUAN, PUERTO RICO  
 SOURCE: DEPARTMENT OF HEALTH, ASPESI, DIVISION OF STATISTICS, SAN JUAN, PUERTO RICO

Tabla 6 - TASAS\* DE MORTALIDAD GENERAL POR REGIONES DE SALUD, MUNICIPIO DE RESIDENCIA Y CAUSAS ESPECIFICAS  
 Table 6 - GENERAL MORTALITY RATES BY REGIONS OF HEALTH, MUNICIPALITY OF RESIDENCE AND SELECTED CAUSES  
 PUERTO RICO, 1999

Pag 1 de 6

MUNICIPIOS MUNICIPALITIES	TOTAL		ENF. CORAZON Heart Diseases		CANCER		DIABETES MELLITUS		ACCIDENTES ACCIDENTS		SIDA		Cerebrovasculares Cerebrovasc. Dis.	
	Núm.	Tasa	Núm.	Tasa	Núm.	Tasa	Núm.	Tasa	Núm.	Tasa	Núm.	Tasa	Núm.	Tasa
<b>TOTAL</b>	<b>29,145</b>	<b>753.8</b>	<b>5,364</b>	<b>138.7</b>	<b>4,429</b>	<b>114.6</b>	<b>2,184</b>	<b>56.5</b>	<b>1,269</b>	<b>32.8</b>	<b>610</b>	<b>15.8</b>	<b>1,266</b>	<b>32.7</b>
REGION ARECIBO	3,590	773.2	588	126.6	518	111.6	306	65.9	142	30.6	64	13.8	143	30.8
AREA DE ARECIBO	2,110	783.1	330	122.5	297	110.2	200	74.2	76	28.2	28	10.4	73	27.1
ARECIBO	924	908.5	140	137.7	138	135.7	82	80.6	35	34.4	19	18.7	28	27.5
CAMUY	213	644.6	35	105.9	18	54.5	23	69.6	8	24.2	1	3	9	27.2
HATILLO	291	715.8	42	103.3	41	100.8	27	66.4	11	27.1	4	9.8	11	27.1
LARES	222	676.4	38	115.8	34	103.6	15	45.7	6	18.3	-	-	11	33.5
QUEBRADILLAS	164	632.2	26	100.2	17	65.5	22	84.8	7	27	2	7.7	5	19.3
UTUADO	296	839.4	49	138.9	49	138.9	31	87.9	9	25.5	2	5.7	9	25.5
AREA DE MANATI	1,480	759.5	258	132.4	221	113.4	106	54.4	66	33.9	36	18.5	70	35.9
BARCELONETA	186	679.8	33	120.6	28	102.3	17	62.1	19	69.4	1	3.7	3	11
CIALES	172	824.4	26	124.6	24	115	13	62.3	6	28.8	6	28.8	6	28.8
FLORIDA	88	971.9	15	165.7	16	176.7	8	88.4	2	22.1	2	22.1	3	33.1
MANATI	343	820.2	59	141.1	55	131.5	27	64.6	11	26.3	16	38.3	17	40.6
MOROVIS	183	541.2	27	79.9	28	82.8	13	38.4	6	17.7	4	11.8	12	35.5
VEGA BAJA	508	819.8	98	158.2	70	113	28	45.2	22	35.5	7	11.3	29	46.8
REGION BAYAMON	4,186	659.1	776	122.2	637	100.3	294	46.3	191	30.1	100	15.7	180	28.3
AREA BARRANQUITAS	910	650	161	115	103	73.6	65	46.4	37	26.4	17	12.1	50	35.7
BARRANQUITAS	206	713.8	30	104	19	65.8	20	69.3	7	24.3	5	17.3	9	31.2
COMERIO	143	698.9	26	127.1	12	58.6	9	44	8	39.1	-	-	15	73.3
COROZAL	222	606.9	43	117.5	19	51.9	15	41	12	32.8	5	13.7	8	21.9
NARANJITO	193	663.3	34	116.8	34	116.8	14	48.1	5	17.2	4	13.7	6	20.6
OROCOVIS	146	583.9	28	112	19	76	7	28	5	20	3	12	12	48
AREA DE BAYAMON	2,249	673.8	441	132.1	363	108.7	156	46.7	111	33.3	50	15	83	24.9
BAYAMON	1,720	731.1	348	147.9	279	118.6	127	54	77	32.7	46	19.6	61	25.9
TOA ALTA	283	462.3	47	76.8	48	78.4	18	29.4	19	31	3	4.9	14	22.9
VEGA ALTA	246	659	46	123.2	36	96.4	11	29.5	15	40.2	1	2.7	8	21.4
AREA DE CATAÑO	1,027	636.7	174	107.9	171	106	73	45.3	43	26.7	33	20.5	47	29.1
CATAÑO	241	748.8	34	105.6	31	96.3	14	43.5	10	31.1	15	46.6	8	24.9
DORADO	240	688.4	34	97.5	48	137.7	20	57.4	12	34.4	4	11.5	14	40.2
TOA BAJA	546	579.2	106	112.4	92	97.6	39	41.4	21	22.3	14	14.9	25	26.5
REGION DE CAGUAS	4,126	697.1	796	134.5	599	101.2	257	43.4	191	32.3	85	14.4	188	31.8
AREA DE CAGUAS	2,143	735.5	375	128.7	295	101.2	140	48	111	38.1	38	13	89	30.5
AGUAS BUENAS	213	673	31	97.9	31	97.9	21	66.4	11	34.8	3	9.5	14	44.2
CAGUAS	1,139	789.1	217	150.3	153	106	65	45	51	35.3	21	14.5	42	29.1
GURABO	226	668.4	36	106.5	27	79.9	21	62.1	14	41.4	6	17.7	9	26.6
JUNCOS	261	602.4	38	87.7	36	83.1	15	34.6	18	41.5	6	13.8	11	25.4
SAN LORENZO	304	795.1	53	138.6	48	125.5	18	47.1	17	44.5	2	5.2	13	34
AREA DE CAYEY	803	625.6	147	114.5	129	100.5	39	30.4	35	27.3	17	13.2	43	33.5
AIBONITO	193	693.5	30	107.8	34	122.2	7	25.2	11	39.5	2	7.2	17	61.1
CAYEY	387	761.5	79	155.4	54	106.3	19	37.4	16	31.5	8	15.7	13	25.6
CIDRA	223	448.7	38	76.5	41	82.5	13	26.2	8	16.1	7	14.1	13	26.2
AREA DE HUMACAO	1,180	685.5	274	159.2	175	101.7	78	45.3	45	26.1	30	17.4	56	32.5
HUMACAO	414	693.5	81	135.7	75	125.6	27	45.2	21	35.2	9	15.1	20	33.5
LAS PIEDRAS	209	654.3	39	122.1	31	97	17	53.2	4	12.5	4	12.5	8	25
MAUNABO	90	652.7	23	166.8	9	65.3	8	58	3	21.8	4	29	5	36.3
NAGUABO	201	796.8	68	269.6	25	99.1	17	67.4	5	19.8	5	19.8	11	43.6
YABUCOA	266	641.1	63	151.8	35	84.4	9	21.7	12	28.9	8	19.3	12	28.9



Tabla 6 - TASAS\* DE MORTALIDAD GENERAL POR REGIONES DE SALUD, MUNICIPIO DE RESIDENCIA Y CAUSAS ESPECIFICAS  
 Table 6 - GENERAL MORTALITY RATES BY REGIONS OF HEALTH, MUNICIPALITY OF RESIDENCE AND SELECTED CAUSES  
 PUERTO RICO, 1999

MUNICIPIOS MUNICIPALITIES	TOTAL		ENF. CORAZON Heart Diseases		CANCER		DIABETES MELLITUS		ACCIDENTES ACCIDENTS		SIDA		Cerebrovasculares Cerebrovasc. Dis.	
	Núm.	Tasa	Núm.	Tasa	Núm.	Tasa	Núm.	Tasa	Núm.	Tasa	Núm.	Tasa	Núm.	Tasa
REGION MAYAGUEZ	2,580	817.9	469	148.7	407	129	259	82.1	83	26.3	38	12	93	29.5
AREA DE MAYAGUEZ	1,826	813.6	331	147.5	288	128.3	189	84.2	62	27.6	29	12.9	64	28.5
AÑASCO	213	750.3	35	123.3	35	123.3	20	70.4	2	7	4	14.1	13	45.8
CABO ROJO	412	839.4	76	154.8	59	120.2	40	81.5	21	42.8	6	12.2	12	24.4
HORMIGUEROS	125	736.6	20	117.8	21	123.7	13	76.6	8	47.1	1	5.9	2	11.8
LAS MARIAS	67	681.7	22	223.9	9	91.6	9	91.6	-	-	1	10.2	2	20.4
MARICAO	33	541.3	3	49.2	6	98.4	5	82	1	16.4	-	-	1	16.4
MAYAGUEZ	863	864.3	155	155.2	134	134.2	92	92.1	23	23	15	15	31	31
RINCON	113	794	20	140.5	24	168.6	10	70.3	7	49.2	2	14.1	3	21.1
AREA DE SAN GERMAN	754	828.7	138	151.7	119	130.8	70	76.9	21	23.1	9	9.9	29	31.9
LAJAS	209	756.4	31	112.2	34	123.1	17	61.5	7	25.3	3	10.9	12	43.4
SABANA GRANDE	217	876.2	48	193.8	36	145.4	19	76.7	6	24.2	2	8.1	6	24.2
SAN GERMAN	328	850.1	59	152.9	49	127	34	88.1	8	20.7	4	10.4	11	28.5
SUB REGION AGUADILLA	1,742	753.8	358	154.9	250	108.2	176	76.2	81	35.1	12	5.2	66	28.6
AGUADA	281	706.5	68	171	32	80.5	26	65.4	14	35.2	3	7.5	15	37.7
AGUADILLA	522	783.1	90	135	84	126	52	78	22	33	4	6	20	30
ISABELA	354	825.8	60	140	63	147	38	88.6	18	42	4	9.3	11	25.7
MOCA	241	630.9	48	125.7	32	83.8	26	68.1	10	26.2	-	-	6	15.7
SAN SEBASTIAN	344	789.1	92	211	39	89.5	34	78	17	39	1	2.3	14	32.1
REGION PONCE	4,616	768.6	936	155.8	703	117.1	349	58.1	187	31.1	76	12.7	251	41.8
AREA DE GUAYAMA	921	793.8	173	149.1	154	132.7	58	50	44	37.9	17	14.7	57	49.1
ARROYO	161	803.6	31	154.7	26	129.8	10	49.9	7	34.9	1	5	6	29.9
GUAYAMA	343	783.1	65	148.4	64	146.1	17	38.8	21	47.9	5	11.4	25	57.1
PATILLAS	159	730.4	30	137.8	25	114.8	14	64.3	5	23	1	4.6	9	41.3
SALINAS	258	848.1	47	154.5	39	128.2	17	55.9	11	36.2	10	32.9	17	55.9
AREA DE PONCE	2,794	770.5	564	155.5	432	119.1	203	56	102	28.1	50	13.8	140	38.6
ADJUNTAS	156	798.9	41	210	17	87.1	6	30.7	5	25.6	1	5.1	18	92.2
COAMO	277	746.6	63	169.8	47	126.7	21	56.6	6	16.2	4	10.8	13	35
JAYUYA	109	649.1	23	137	12	71.5	15	89.3	4	23.8	2	11.9	8	47.6
JUANA DIAZ	387	742.3	59	113.2	63	120.8	23	44.1	16	30.7	8	15.3	21	40.3
PONCE	1,579	820.3	317	164.7	259	134.6	112	58.2	59	30.7	32	16.6	68	35.3
SANTA ISABEL	136	678.7	26	129.8	15	74.9	11	54.9	6	29.9	2	10	4	20
VILLALBA	150	610.7	35	142.5	19	77.4	15	61.1	6	24.4	1	4.1	8	32.6
AREA DE YAUCO	901	739	199	163.2	117	96	88	72.2	41	33.6	9	7.4	54	44.3
GUANICA	175	813.8	35	162.8	24	111.6	16	74.4	14	65.1	2	9.3	5	23.3
GUAYANILLA	189	666.3	42	148.1	29	102.2	17	59.9	4	14.1	1	3.5	12	42.3
PEÑUELAS	158	584.4	37	136.9	23	85.1	26	96.2	9	33.3	2	7.4	4	14.8
YAUCO	379	842	85	188.8	41	91.1	29	64.4	14	31.1	4	8.9	33	73.3
REGION METROPOLITANA	7,088	796.6	1,218	136.9	1,107	124.4	461	51.8	316	35.5	211	23.7	292	32.8
AREA DE CAROLINA	2,242	643.4	373	107	355	101.9	155	44.5	106	30.4	52	14.9	88	25.3
CANOVANAS	310	600.6	56	108.5	44	85.2	22	42.6	14	27.1	11	21.3	12	23.2
CAROLINA	1,343	703.4	236	123.6	218	114.2	105	55	59	30.9	32	16.8	50	26.2
LOIZA	177	634.3	19	68.1	22	78.8	11	39.4	11	39.4	6	21.5	6	21.5
TRUJILLO ALTO	412	528.3	62	79.5	71	91	17	21.8	22	28.2	3	3.8	20	25.6
AREA DE SAN JUAN	4,846	895.1	845	156.1	752	138.9	306	56.5	210	38.8	159	29.4	204	37.7
GUAYNABO	712	682.6	124	118.9	118	113.1	39	37.4	35	33.6	26	24.9	35	33.6
SAN JUAN	4,134	945.9	721	165	634	145.1	267	61.1	175	40	133	30.4	169	38.7
SUB REGION FAJARDO	1,029	744.4	181	130.9	185	133.8	78	56.4	50	36.2	22	15.9	49	35.4
CEIBA	105	557.5	12	63.7	19	100.9	10	53.1	7	37.2	1	5.3	4	21.2
CULEBRA	16	909.1	5	284.1	1	56.8	-	-	-	-	-	-	2	113.6

Tabla 6 - TASAS\* DE MORTALIDAD GENERAL POR REGIONES DE SALUD, MUNICIPIO DE RESIDENCIA Y CAUSAS ESPECIFICAS  
 Table 6 - GENERAL MORTALITY RATES BY REGIONS OF HEALTH, MUNICIPALITY OF RESIDENCE AND SELECTED CAUSES  
 PUERTO RICO, 1999

MUNICIPIOS MUNICIPALITIES	TOTAL		ENF. CORAZON Heart Diseases		CANCER		DIABETES MELLITUS		ACCIDENTES ACCIDENTS		SIDA		Cerebrovasculares Cerebrovasc. Dis.	
	Núm.	Tasa	Núm.	Tasa	Núm.	Tasa	Núm.	Tasa	Núm.	Tasa	Núm.	Tasa	Núm.	Tasa
FAJARDO	308	802.6	53	138.1	63	164.2	20	52.1	12	31.3	9	23.5	14	36.5
LUQUILLO	152	810	27	143.9	30	159.9	18	95.9	11	58.6	1	5.3	-	-
RIO GRANDE	363	712.3	65	127.5	55	107.9	23	45.1	19	37.3	9	17.7	24	47.1
VIEQUES	85	892.1	19	199.4	17	178.4	7	73.5	1	10.5	2	21	5	52.5
P R NO ESPECIFICADO	-	-	-	-	-	-	-	-	-	-	-	-	-	-
NO RESIDENTE	180	-	41	-	22	-	4	-	28	-	2	-	4	-
CANADA	4	-	-	-	2	-	1	-	-	-	-	-	-	-
CUBA	1	-	-	-	-	-	-	-	-	-	-	-	-	-
ESTADOS UNIDOS	103	-	34	-	6	-	2	-	19	-	2	-	1	-
GUAM	-	-	-	-	-	-	-	-	-	-	-	-	-	-
ISLAS VIRGENES	36	-	1	-	11	-	-	-	3	-	-	-	-	-
MEJICO	1	-	-	-	-	-	-	-	-	-	-	-	-	-
EPUBLICA DOMINICAN	8	-	2	-	-	-	1	-	4	-	-	-	-	-
OTROS PAISES	27	-	4	-	3	-	-	-	2	-	-	-	3	-
DESCONOCIDOS	8	-	1	-	1	-	-	-	-	-	-	-	-	-



Tabla 6 - TASAS\* DE MORTALIDAD GENERAL POR REGIONES DE SALUD, MUNICIPIO DE RESIDENCIA Y CAUSAS ESPECIFICAS  
 Table 6 - GENERAL MORTALITY RATES BY REGIONS OF HEALTH, MUNICIPALITY OF RESIDENCE AND SELECTED CAUSES  
 PUERTO RICO, 1999

Pag 4 de 6

MUNICIPIOS MUNICIPALITIES	ENF. PULMONAR OBST. - COPD		NEUMONIA E INFLUENZA		HIPERTENSIVAS HIPERTENSIVE		HOMICIDIOS HOMICIDES		CIRROSIS HEPATICA CIRROSIS OF LIVER		SEPTICEMIA SEPTICAEMIA		OTRAS CAUSAS OTHER CAUSES	
	Núm.	Tasa	Núm.	Tasa	Núm.	Tasa	Núm.	Tasa	Núm.	Tasa	Núm.	Tasa	Núm.	Tasa
<b>TOTAL</b>	<b>1,240</b>	<b>32.1</b>	<b>1,069</b>	<b>27.6</b>	<b>1,617</b>	<b>41.8</b>	<b>705</b>	<b>18.2</b>	<b>878</b>	<b>22.7</b>	<b>726</b>	<b>18.8</b>	<b>7,788</b>	<b>201.4</b>
REGION ARECIBO	251	54.1	147	31.7	212	45.7	40	8.6	89	19.2	94	20.2	996	214.5
AREA DE ARECIBO	166	61.6	79	29.3	125	46.4	24	8.9	53	19.7	57	21.2	602	223.4
ARECIBO	60	59	30	29.5	54	53.1	21	20.6	20	19.7	23	22.6	274	269.4
CAMUY	18	54.5	11	33.3	10	30.3	1	3	6	18.2	5	15.1	68	205.8
HATILLO	22	54.1	13	32	15	36.9	1	2.5	10	24.6	12	29.5	82	201.7
LARES	25	76.2	12	36.6	12	36.6	-	-	8	24.4	2	6.1	59	179.8
QUEBRADILLAS	18	69.4	5	19.3	11	42.4	-	-	3	11.6	9	34.7	39	150.3
UTUADO	23	65.2	8	22.7	23	65.2	1	2.8	6	17	6	17	80	226.9
AREA DE MANATI	85	43.6	68	34.9	87	44.6	16	8.2	36	18.5	37	19	394	202.2
BARCELONETA	12	43.9	5	18.3	8	29.2	2	7.3	6	21.9	4	14.6	48	175.4
CIALES	9	43.1	11	52.7	12	57.5	3	14.4	5	24	1	4.8	50	239.6
FLORIDA	2	22.1	1	11	6	66.3	1	11	-	-	3	33.1	29	320.3
MANATI	18	43	11	26.3	15	35.9	1	2.4	6	14.3	10	23.9	97	231.9
MOROVIS	14	41.4	10	29.6	11	32.5	1	3	6	17.7	7	20.7	44	130.1
VEGA BAJA	30	48.4	30	48.4	35	56.5	8	12.9	13	21	12	19.4	126	203.3
REGION BAYAMON	186	29.3	116	18.3	251	39.5	104	16.4	142	22.4	101	15.9	1,108	174.5
AREA BARRANQUITAS	64	45.7	38	27.1	58	41.4	13	9.3	39	27.9	15	10.7	250	178.6
BARRANQUITAS	23	79.7	8	27.7	9	31.2	-	-	14	48.5	5	17.3	57	197.5
COMERIO	8	39.1	7	34.2	11	53.8	2	9.8	7	34.2	2	9.8	36	175.9
COROZAL	12	32.8	8	21.9	21	57.4	6	16.4	8	21.9	2	5.5	63	172.2
NARANJITO	13	44.7	9	30.9	8	27.5	4	13.7	6	20.6	3	10.3	53	182.1
OROCOVIS	8	32	6	24	9	36	1	4	4	16	3	12	41	164
AREA DE BAYAMON	76	22.8	54	16.2	124	37.1	46	13.8	75	22.5	63	18.9	607	181.8
BAYAMON	54	23	40	17	80	34	38	16.2	56	23.8	47	20	467	198.5
TOA ALTA	9	14.7	7	11.4	20	32.7	3	4.9	13	21.2	9	14.7	73	119.2
VEGA ALTA	13	34.8	7	18.8	24	64.3	5	13.4	6	16.1	7	18.8	67	179.5
AREA DE CATAÑO	46	28.5	24	14.9	69	42.8	45	27.9	28	17.4	23	14.3	251	155.6
CATAÑO	12	37.3	10	31.1	13	40.4	6	18.6	8	24.9	8	24.9	72	223.7
DORADO	14	40.2	6	17.2	16	45.9	6	17.2	9	25.8	6	17.2	51	146.3
TOA BAJA	20	21.2	8	8.5	40	42.4	33	35	11	11.7	9	9.5	128	135.8
REGION DE CAGUAS	176	29.7	152	25.7	224	37.8	102	17.2	143	24.2	120	20.3	1,093	184.7
AREA DE CAGUAS	90	30.9	93	31.9	116	39.8	60	20.6	82	28.1	66	22.7	588	201.8
AGUAS BUENAS	14	44.2	9	28.4	18	56.9	3	9.5	5	15.8	4	12.6	49	154.8
CAGUAS	49	33.9	54	37.4	55	38.1	33	22.9	52	36	43	29.8	304	210.6
GURABO	10	29.6	9	26.6	9	26.6	8	23.7	5	14.8	3	8.9	69	204.1
JUNCOS	5	11.5	9	20.8	17	39.2	12	27.7	11	25.4	11	25.4	72	166.2
SAN LORENZO	12	31.4	12	31.4	17	44.5	4	10.5	9	23.5	5	13.1	94	245.9
AREA DE CAYEY	45	35.1	27	21	41	31.9	20	15.6	27	21	27	21	206	160.5
AIBONITO	17	61.1	5	18	9	32.3	2	7.2	5	18	5	18	49	176.1
CAYEY	15	29.5	17	33.5	20	39.4	14	27.5	15	29.5	13	25.6	104	204.6
CIDRA	13	26.2	5	10.1	12	24.1	4	8	7	14.1	9	18.1	53	106.6
AREA DE HUMACAO	41	23.8	32	18.6	67	38.9	22	12.8	34	19.8	27	15.7	299	173.7
HUMACAO	13	21.8	12	20.1	23	38.5	3	5	9	15.1	15	25.1	106	177.6
LAS PIEDRAS	6	18.8	7	21.9	12	37.6	6	18.8	6	18.8	5	15.7	64	200.4
MAUNABO	4	29	1	7.3	7	50.8	2	14.5	5	36.3	3	21.8	16	116
NAGUABO	9	35.7	4	15.9	8	31.7	6	23.8	4	15.9	1	4	38	150.6
YABUCOA	9	21.7	8	19.3	17	41	5	12.1	10	24.1	3	7.2	75	180.8

Tabla 6 - TASAS\* DE MORTALIDAD GENERAL POR REGIONES DE SALUD, MUNICIPIO DE RESIDENCIA Y CAUSAS ESPECIFICAS  
 Table 6 - GENERAL MORTALITY RATES BY REGIONS OF HEALTH, MUNICIPALITY OF RESIDENCE AND SELECTED CAUSES  
 PUERTO RICO, 1999

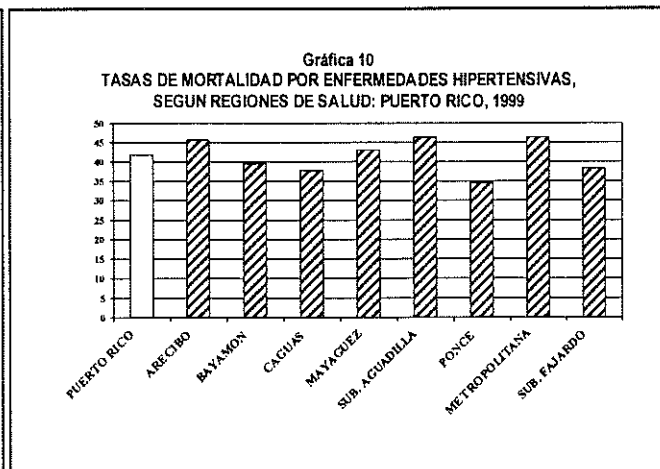
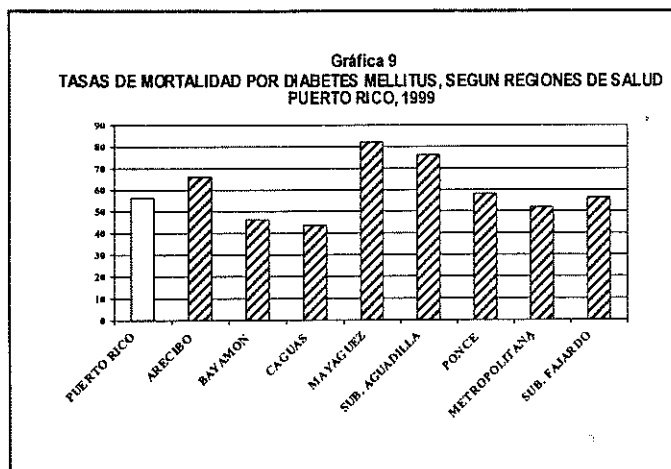
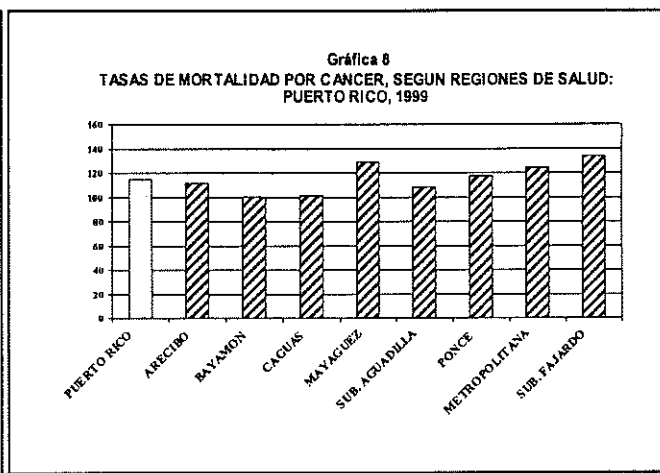
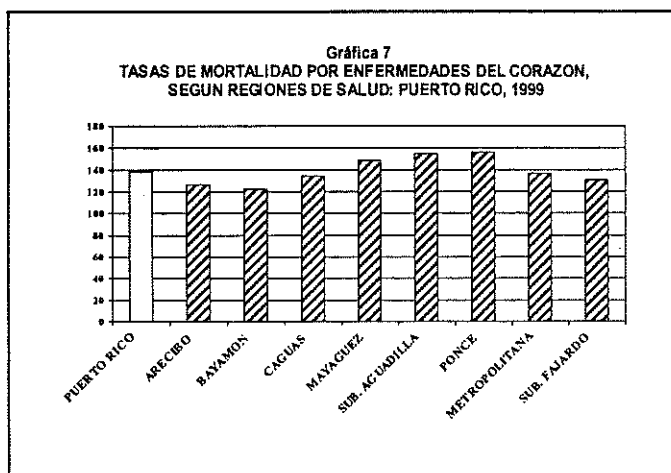
Pag 5 de 6

MUNICIPIOS MUNICIPALITIES	ENF. PULMONAR OBST. - COPD		NEUMONIA E INFLUENZA		HIPERTENSIVAS HIPERTENSIVE		HOMICIDIOS HOMICIDES		CIRROSIS HEPATICA CIRROSIS OF LIVER		SEPTICEMIA SEPTICAEMIA		OTRAS CAUSAS OTHER CAUSES	
	Núm.	Tasa	Núm.	Tasa	Núm.	Tasa	Núm.	Tasa	Núm.	Tasa	Núm.	Tasa	Núm.	Tasa
REGION MAYAGUEZ	90	28.5	100	31.7	136	43.1	27	8.6	96	30.4	65	20.6	717	227.3
AREA DE MAYAGUEZ	60	26.7	77	34.3	96	42.8	22	9.8	70	31.2	46	20.5	492	219.2
AÑASCO	11	38.7	5	17.6	16	56.4	1	3.5	11	38.7	6	21.1	54	190.2
CABO ROJO	10	20.4	21	42.8	20	40.7	3	6.1	17	34.6	7	14.3	120	244.5
HORMIGUEROS	4	23.6	5	29.5	6	35.4	1	5.9	4	23.6	4	23.6	36	212.1
LAS MARIAS	-	-	4	40.7	5	50.9	-	-	1	10.2	-	-	14	142.5
MARICAO	1	16.4	2	32.8	-	-	1	16.4	1	16.4	1	16.4	11	180.4
MAYAGUEZ	30	30	34	34.1	44	44.1	16	16	28	28	25	25	236	236.4
RINCON	4	28.1	6	42.2	5	35.1	-	-	8	56.2	3	21.1	21	147.6
AREA DE SAN GERMAN	30	33	23	25.3	40	44	5	5.5	26	28.6	19	20.9	225	247.3
LAJAS	9	32.6	6	21.7	18	65.1	1	3.6	10	36.2	4	14.5	57	206.3
SABANA GRANDE	8	32.3	4	16.2	9	36.3	2	8.1	6	24.2	6	24.2	65	262.4
SAN GERMAN	13	33.7	13	33.7	13	33.7	2	5.2	10	25.9	9	23.3	103	267
SUB REGION AGUADILLA	86	37.2	62	26.8	107	46.3	10	4.3	46	19.9	47	20.3	441	190.8
AGUADA	15	37.7	14	35.2	16	40.2	2	5	4	10.1	6	15.1	66	165.9
AGUADILLA	21	31.5	15	22.5	43	64.5	5	7.5	18	27	16	24	132	198
ISABELA	15	35	11	25.7	18	42	1	2.3	8	18.7	9	21	98	228.6
MOCA	13	34	10	26.2	15	39.3	1	2.6	8	20.9	6	15.7	66	172.8
SAN SEBASTIAN	22	50.5	12	27.5	15	34.4	1	2.3	8	18.4	10	22.9	79	181.2
REGION PONCE	207	34.5	127	21.1	208	34.6	114	19	127	21.1	105	17.5	1,226	204.1
AREA DE GUAYAMA	42	36.2	19	16.4	52	44.8	18	15.5	31	26.7	23	19.8	233	200.8
ARROYO	8	39.9	3	15	11	54.9	4	20	3	15	6	29.9	45	224.6
GUAYAMA	13	29.7	10	22.8	15	34.2	6	13.7	12	27.4	2	4.6	88	200.9
PATILLAS	4	18.4	2	9.2	14	64.3	1	4.6	8	36.7	4	18.4	42	192.9
SALINAS	17	55.9	4	13.1	12	39.4	7	23	8	26.3	11	36.2	58	190.7
AREA DE PONCE	131	36.1	73	20.1	118	32.5	88	24.3	73	20.1	67	18.5	753	207.6
ADJUNTAS	12	61.5	1	5.1	5	25.6	2	10.2	5	25.6	4	20.5	39	199.7
COAMO	15	40.4	6	16.2	13	35	1	2.7	4	10.8	6	16.2	78	210.2
JAYUYA	8	47.6	1	6	1	6	-	-	3	17.9	1	6	31	184.6
JUANA DIAZ	9	17.3	11	21.1	18	34.5	13	24.9	9	17.3	8	15.3	129	247.4
PONCE	74	38.4	47	24.4	71	36.9	68	35.3	42	21.8	43	22.3	387	201.1
SANTA ISABEL	4	20	3	15	7	34.9	3	15	5	25	5	25	45	224.6
VILLALBA	9	36.6	4	16.3	3	12.2	1	4.1	5	20.4	-	-	44	179.1
AREA DE YAUCO	34	27.9	35	28.7	38	31.2	8	6.6	23	18.9	15	12.3	240	196.9
GUANICA	4	18.6	5	23.3	14	65.1	4	18.6	4	18.6	3	14	45	209.3
GUAYANILLA	9	31.7	8	28.2	6	21.2	-	-	5	17.6	2	7.1	54	190.4
PEWELAS	-	-	2	7.4	5	18.5	2	7.4	3	11.1	4	14.8	41	151.6
YAUCO	21	46.7	20	44.4	13	28.9	2	4.4	11	24.4	6	13.3	100	222.2
REGION METROPOLITANA	212	23.8	321	36.1	412	46.3	267	30	200	22.5	170	19.1	1,901	213.6
AREA DE CAROLINA	64	18.4	99	28.4	148	42.5	75	21.5	72	20.7	59	16.9	596	171
CANOVANAS	11	21.3	14	27.1	19	36.8	17	32.9	8	15.5	7	13.6	75	145.3
CAROLINA	33	17.3	62	32.5	98	51.3	28	14.7	49	25.7	32	16.8	341	178.6
LOIZA	6	21.5	7	25.1	11	39.4	16	57.3	6	21.5	4	14.3	52	186.3
TRUJILLO ALTO	14	18	16	20.5	20	25.6	14	18	9	11.5	16	20.5	128	164.1
AREA DE SAN JUAN	148	27.3	222	41	264	48.8	192	35.5	128	23.6	111	20.5	1,305	241.1
GUAYNABO	21	20.1	37	35.5	27	25.9	24	23	24	23	13	12.5	189	181.2
SAN JUAN	127	29.1	185	42.3	237	54.2	168	38.4	104	23.8	98	22.4	1,116	255.3
SUB REGION FAJARDO	26	18.8	37	26.8	53	38.3	32	23.2	31	22.4	22	15.9	263	190.3
CEIBA	3	15.9	5	26.5	6	31.9	2	10.6	4	21.2	4	21.2	28	148.7
CULEBRA	1	56.8	-	-	-	-	-	-	1	56.8	-	-	6	340.9

Tabla 6 - TASAS\* DE MORTALIDAD GENERAL POR REGIONES DE SALUD, MUNICIPIO DE RESIDENCIA Y CAUSAS ESPECIFICAS  
 Table 6 - GENERAL MORTALITY RATES BY REGIONS OF HEALTH, MUNICIPALITY OF RESIDENCE AND SELECTED CAUSES  
 PUERTO RICO, 1999

Pag 6 de 6

MUNICIPIOS MUNICIPALITIES	ENF. PULMONAR OBST. - COPD		NEUMONIA E INFLUENZA		HIPERTENSIVAS HIPERTENSIVE		HOMICIDIOS HOMICIDES		CIRROSIS HEPATICA CIRROSIS OF LIVER		SEPTICEMIA SEPTICAEMIA		OTRAS CAUSAS OTHER CAUSES	
	Núm.	Tasa	Núm.	Tasa	Núm.	Tasa	Núm.	Tasa	Núm.	Tasa	Núm.	Tasa	Núm.	Tasa
	FAJARDO	6	15.6	13	33.9	13	33.9	9	23.5	5	13	9	23.5	82
LUQUILLO	4	21.3	4	21.3	11	58.6	3	16	5	26.6	1	5.3	37	197.2
RIO GRANDE	11	21.6	14	27.5	16	31.4	17	33.4	12	23.5	5	9.8	93	182.5
VIEQUES	1	10.5	1	10.5	7	73.5	1	10.5	4	42	3	31.5	17	178.4
P R NO ESPECIFICADO	-	-	-	-	-	-	-	-	-	-	-	-	-	-
NO RESIDENTE	6	-	6	-	13	-	9	-	3	-	1	-	41	-
CANADA	-	-	-	-	-	-	-	-	-	-	-	-	1	-
CUBA	1	-	-	-	-	-	-	-	-	-	-	-	-	-
ESTADOS UNIDOS	2	-	2	-	10	-	4	-	2	-	1	-	18	-
GUAM	-	-	-	-	-	-	-	-	-	-	-	-	-	-
ISLAS VIRGENES	1	-	3	-	2	-	2	-	-	-	-	-	13	-
MEJICO	1	-	-	-	-	-	-	-	-	-	-	-	-	-
REPUBLICA DOMINICANA	-	-	-	-	-	-	1	-	-	-	-	-	-	-
OTROS PAISES	1	-	1	-	1	-	2	-	1	-	-	-	9	-
DESCONOCIDOS	-	-	1	-	1	-	-	-	1	-	1	-	2	-

\* TASAS POR 100,000 HABITANTES - RATES PER 100,000 HABITANTS

FUENTE: DEPARTAMENTO DE SALUD, SAPEESI, DIVISION DE ESTADISTICAS, SAN JUAN, PR.

SOURCE: DEPARTMENT OF HEALTH, ASPESIS, DIVISION OF STATISTICS, SAN JUAN, PR.

Gráfica 11  
 DISTRIBUCION PORCENTUAL DE CAUSAS ESPECIFICAS DE MUERTE  
 PUERTO RICO, 1999

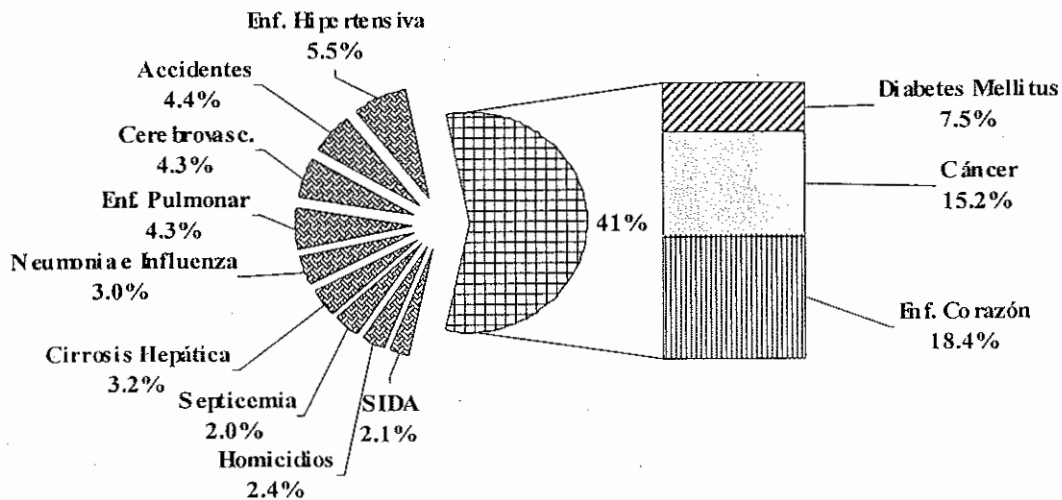

FUENTE: DEPARTAMENTO DE SALUD, SAPEESI, DIVISION DE ESTADISTICAS, SAN JUAN, PUERTO RICO  
 SOURCE: DEPARTMENT OF HEALTH, ASPESIS, DIVISION OF STATISTICS, SAN JUAN, PUERTO RICO

Gráfica 12  
**MUERTES VIOLENTAS\* POR AÑOS**  
**PUERTO RICO, 1963 - 1999**

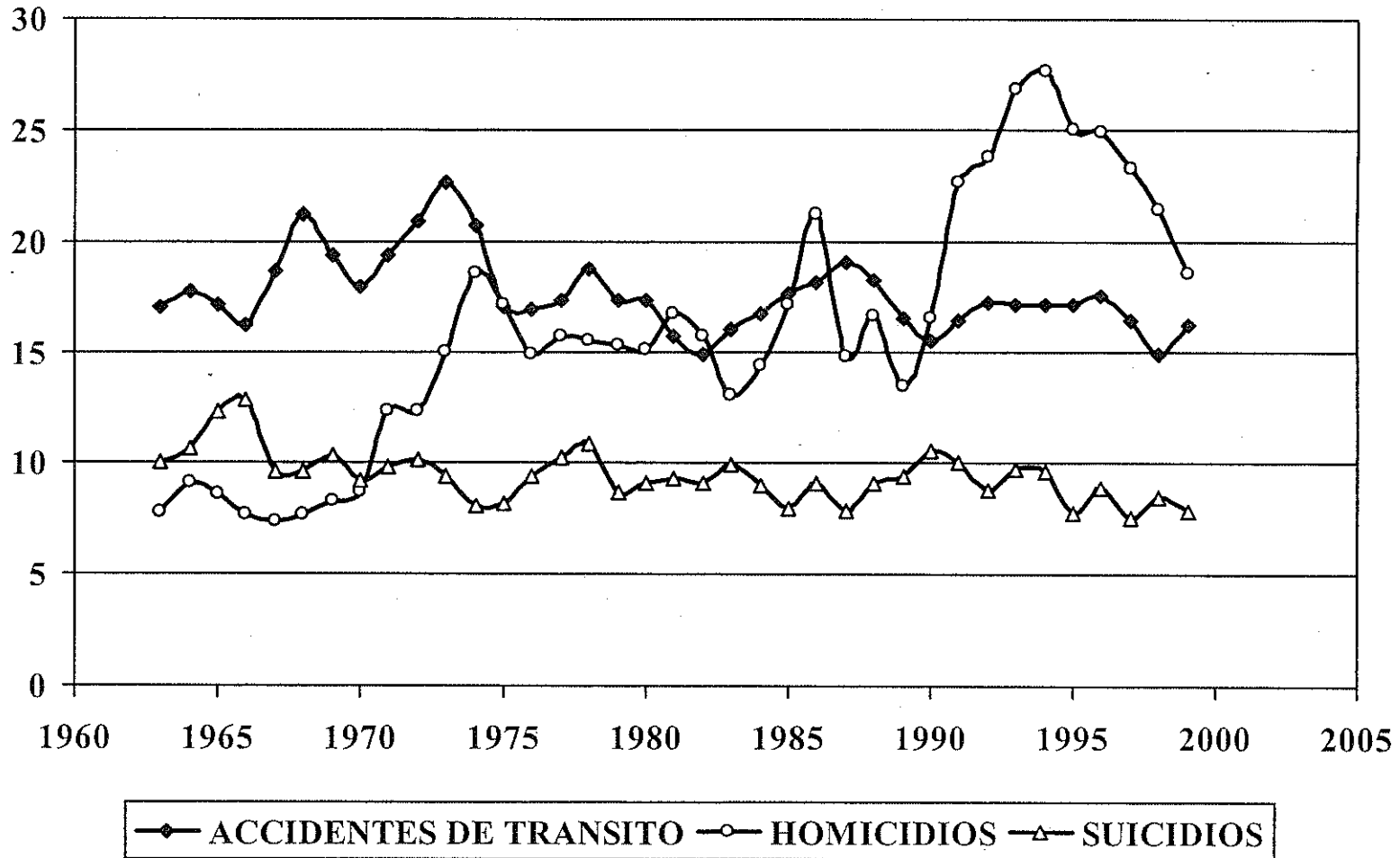

\* TASAS POR 100,000 HABITANTES RATES PER 100,000 POPULATION  
 FUENTE: DEPARTAMENTO DE SALUD, SAPEESI, DIVISION DE ESTADISTICAS, SAN JUAN, PUERTO RICO  
 SOURCE: DEPARTMENT OF HEALTH, ASPESIS, DIVISION OF STATISTICS, SAN JUAN, PUERTO RICO

Tabla 7 - MUERTES VIOLENTAS POR AÑO Y TASAS POR 100,000 HABITANTES  
 Table 7 - VIOLENT DEATHS BY YEAR AND RATES BY 100,000 INHABITANTS  
 PUERTO RICO, 1999

AÑOS YEARS	ACCIDENTES ACCIDENTS		ACCIDENTES DE TRANSITO TRAFFIC - ACCIDENTS		HOMICIDIOS HOMICIDES		SUICIDIOS SUICIDES	
	NUMERO NUMBER	TASA RATE	NUMERO NUMBER	TASA RATE	NUMERO NUMBER	TASA RATE	NUMERO NUMBER	TASA RATE
1999*	1,269	33.4	618	16.2	705	18.5	299	7.9
1998	1,387	36.2	569	14.8	819	21.4	324	8.5
1997	1,582	41.6	623	16.4	881	23.2	288	7.6
1996	1,520	40.7	653	17.5	928	24.9	331	8.9
1995	1,529	41.1	635	17.1	928	25	291	7.8
1994	1,313	35.6	631	17.1	1,017	27.6	355	9.6
1993	1,236	34.5	611	17.1	959	26.8	346	9.7
1992	1,209	33.8	614	17.2	851	23.8	314	8.8
1991	1,154	32.5	581	16.4	803	22.6	355	10
1990	1,136	32.2	548	15.5	583	16.5	371	10.5
1989	1,235	35.3	577	16.5	467	13.4	327	9.4
1988	1,241	35.9	630	18.2	576	16.6	314	9.1
1987	1,173	34.2	652	19	505	14.7	272	7.9
1986	1,096	32.2	618	18.1	723	21.2	310	9.1
1985	1,127	33.4	593	17.6	579	17.1	269	8
1984	958	28.6	559	16.7	479	14.3	300	9
1983	878	26.4	533	16	433	13	328	9.9
1982	874	26.6	487	14.8	517	15.7	300	9.1
1981	891	27.4	512	15.7	543	16.7	302	9.3
1980	990	30.9	554	17.3	483	15.1	292	9.1
1979	1,010	32	547	17.3	483	15.3	274	8.7
1978	1,039	33.3	583	18.7	485	15.5	339	10.9
1977	980	31.9	532	17.3	484	15.7	314	10.2
1976	983	32.6	510	16.9	446	14.8	283	9.4
1975	993	33.8	501	17	502	17.1	241	8.2
1974	1,088	37.6	597	20.7	536	18.5	233	8.1
1973	1,169	40.7	650	22.6	427	14.9	270	9.4
1972	1,104	38.5	599	20.9	352	12.3	288	10.1
1971	1,039	37.4	538	19.4	343	12.3	273	9.8
1970	971	35.7	486	17.9	236	8.7	251	9.2
1969	1,100	40.7	524	19.4	224	8.3	279	10.3
1968	1,071	40.2	566	21.2	206	7.7	255	9.6
1967	1,048	39.8	494	18.6	196	7.4	252	9.6
1966	978	37.4	424	16.2	202	7.7	334	12.8
1965	964	37.3	441	17.1	222	8.6	318	12.3
1964	974	38.3	450	17.7	231	9.1	269	10.6
1963	914	36.7	424	17	195	7.8	248	10
1962	868	35.5	368	15	207	8.5	237	9.7
1961	805	33.5	318	13.2	181	7.5	248	10.3
1960	891	37.7	334	14.2	168	7.1	253	10.7

\* TIPO MUERTE NO ESPECIFICADO - TYPE OF DEATH UNSPECIFIED (TOTAL CASOS 87, TASA 2.3)

FUENTE: DEPARTAMENTO DE SALUD, SAPEESI, DIVISION DE ESTADISTICAS, SAN JUAN, PUERTO RICO.

SOURCE: DEPARTMENT OF HEALTH, ASPESIS, DIVISION OF STATISTICS, SAN JUAN, PUERTO RICO.



Tabla 8 - MUERTES VIOLENTAS POR GRUPO DE EDAD Y TASAS  
 Table 8 - VIOLENT DEATHS BY AGE GROUPS AND RATES  
 PUERTO RICO, 1999

AÑOS YEARS	ACCIDENTES ACCIDENTS		HOMICIDIOS HOMICIDES		SUICIDIOS SUICIDES		SIN DETERMINAR UNDETERMINED	
	NUMERO NUMBER	TASA RATE	NUMERO NUMBER	TASA RATE	NUMERO NUMBER	TASA RATE	NUMERO NUMBER	TASA RATE
<b>TOTAL</b>	<b>1,269</b>	<b>32.8</b>	<b>705</b>	<b>18.2</b>	<b>299</b>	<b>7.7</b>	<b>87</b>	<b>2.3</b>
< 1 AÑO - < 1 YEAR	4	0.6	1	0.2	-	-	1	0.2
1	6	1	1	0.2	-	-	1	0.2
2	4	0.6	1	0.2	-	-	1	0.2
3	5	0.8	-	-	-	-	1	0.2
4	3	0.5	-	-	-	-	-	-
5 - 9	18	0.6	-	-	-	-	-	-
10 - 14	20	0.6	1	-	2	0.1	1	-
15 - 19	88	2.6	114	3.4	11	0.3	5	0.2
20 - 24	122	3.5	205	5.9	14	0.4	11	0.3
25 - 29	96	3	122	3.9	21	0.7	7	0.2
30 - 34	105	3.7	89	3.2	34	1.2	7	0.2
35 - 39	110	4.2	54	2.1	42	1.6	11	0.4
40 - 44	107	4.4	30	1.2	21	0.9	10	0.4
45 - 49	81	3.6	17	0.7	32	1.4	7	0.3
50 - 54	74	3.6	22	1.1	24	1.2	5	0.2
55 - 59	69	4	9	0.5	25	1.5	1	0.1
60 - 64	64	4.5	11	0.8	13	0.9	3	0.2
65 - 69	49	4.1	9	0.8	12	1	4	0.3
70 - 74	53	5.2	7	0.7	16	1.6	5	0.5
75 - 79	51	6.5	5	0.6	15	1.9	2	0.3
80 - 84	63	11.9	3	0.6	12	2.3	1	0.2
85+	75	17.8	3	0.7	5	1.2	3	0.7
SIN ESP (UNSP AGE)	2	-	1	-	-	-	-	-

FUENTE: DEPARTAMENTO DE SALUD, SAPEESI, DIVISION DE ESTADISTICAS, SAN JUAN, PUERTO RICO.

SOURCE: DEPARTMENT OF HEALTH, ASPESIS, DIVISION OF STATISTICS, SAN JUAN, PUERTO RICO.

Tabla 9 - DEFUNCIONES POR OCUPACION, GRUPOS DE EDAD Y SEXO  
 Table 9 - DEATHS BY OCCUPATION, AGE GROUPS AND SEX  
 PUERTO RICO, 1999

Pag 1 de 4

OCUPACION - OCCUPATION	TOTALES			< 15			15 - 19			20 - 24			25 - 29		
	TOTAL	HOMBRES - MALES	MUJERES - FEMALES	TOTAL	HOMBRES - MALES	MUJERES - FEMALES	TOTAL	HOMBRES - MALES	MUJERES - FEMALES	TOTAL	HOMBRES - MALES	MUJERES - FEMALES	TOTAL	HOMBRES - MALES	MUJERES - FEMALES
<b>TOTAL</b>	<b>29,145</b>	<b>16,554</b>	<b>12,591</b>	<b>835</b>	<b>449</b>	<b>386</b>	<b>275</b>	<b>227</b>	<b>48</b>	<b>447</b>	<b>367</b>	<b>80</b>	<b>407</b>	<b>311</b>	<b>96</b>
PROFESIONALES, TECH. PROFESSIONAL, TECH & KINDRED WORKERS	1,469	901	568	-	-	-	-	-	-	4	3	1	10	7	3
MEDICOS Y DENTISTAS PHYSICIAN & DENTIST	64	56	8	-	-	-	-	-	-	-	-	-	-	-	-
AGRICULTORES Y ADM DE FINCAS FARMERS, FARM MANAGER	1,608	1,603	5	1	1	-	1	1	-	3	3	-	4	4	-
ADM.GERENTES, PROPIE- TARIOS EXCEPT FINCAS MANAGER, EXCEPT FARM	2,349	2,049	300	-	-	-	2	2	-	10	10	-	21	15	6
OFICINISTAS Y TRABA- JADORES AFINES CLERICAL & WORKERS	876	412	464	-	-	-	5	3	2	16	9	7	17	8	9
VENDEDORES SALES WORKERS	545	494	51	-	-	-	6	5	1	14	13	1	19	16	3
ARTESANOS, CAPATAZES, TRABAJADORES AFINES CRAFTSMEN, & KINDRED WORKERS	2,372	2,341	31	-	-	-	4	4	-	33	33	-	43	43	-
OPERARIOS, TRAB.AFIN OPERATIVES AND KINDRED WORKERS	3,189	2,541	648	-	-	-	6	6	-	50	46	4	42	40	2
TRAB. DE SERVICIOS SERVICE WORKERS	3,028	2,283	745	-	-	-	14	13	1	50	45	5	46	39	7
OBRERO AGRICOLA Y MAYORDOMO O CAPATAZ FARM, LABORER, FOREMAN	738	731	7	-	-	-	-	-	-	1	1	-	1	1	-
OBRERO, EXC.FNCA, MINA LABORER, EX.FARM, MINE	1,652	1,631	21	1	1	-	26	26	-	62	62	-	59	59	-
ESTUDIANTES STUDENTS	266	190	76	73	46	27	110	83	27	60	45	15	15	11	4
SIN ESPECIFICAR UNSPECIFIED	10,989	1,322	9,667	760	401	359	101	84	17	144	97	47	130	68	62

TABLA - 9 DEFUNCIONES POR OCUPACION, GRUPOS DE EDAD Y SEXO  
 TABLE - 9 DEATHS BY OCCUPATION, AGE GROUPS AND SEX  
 PUERTO RICO, 1999

OCUPACION - OCCUPATION	30 - 34			35 - 39			40 - 44			45 - 49			50 - 54		
	TOTAL	HOMBRES - MALES	MUJERES - FEMALES	TOTAL	HOMBRES - MALES	MUJERES - FEMALES	TOTAL	HOMBRES - MALES	MUJERES - FEMALES	TOTAL	HOMBRES - MALES	MUJERES - FEMALES	TOTAL	HOMBRES - MALES	MUJERES - FEMALES
<b>TOTAL</b>	<b>551</b>	<b>405</b>	<b>146</b>	<b>636</b>	<b>448</b>	<b>188</b>	<b>787</b>	<b>555</b>	<b>232</b>	<b>961</b>	<b>662</b>	<b>299</b>	<b>1,321</b>	<b>868</b>	<b>453</b>
PROFESIONALES,TECH. PROFESSIONAL,TECH & KINDRED WORKERS	23	15	8	36	24	12	54	37	17	79	38	41	94	57	37
MEDICOS Y DENTISTAS PHYSICIAN & DENTIST	-	-	-	1	1	-	2	2	-	4	1	3	3	1	2
AGRICULTORES Y ADM DE FINCAS FARMERS,FARM MANAGER	6	6	-	5	5	-	17	17	-	21	21	-	30	30	-
ADM.GERENTES,PROPIE- TARIOS EXCEPT FINCAS MANAGER,EXCEPT FARM	27	20	7	39	30	9	36	27	9	69	56	13	125	106	19
OFICINISTAS Y TRABA- JADORES AFINES CLERICAL & WORKERS	28	12	16	31	15	16	41	17	24	46	21	25	63	23	40
VENDEDORES SALES WORKERS	16	14	2	15	15	-	21	17	4	34	30	4	27	23	4
ARTESANOS,CAPATACES, TRABAJADORES AFINES CRAFTSMEN,& KINDRED WORKERS	53	53	-	81	78	3	110	109	1	123	120	3	156	154	2
OPÉRARIOS,TRAB.AFIN OPERATIVES AND KINDRED WORKERS	46	41	5	57	44	13	104	88	16	122	107	15	167	139	28
TRAB. DE SERVICIOS SERVICE WORKERS	82	71	11	77	63	14	88	77	11	117	88	29	186	146	40
OBRERO AGRICOLA Y MAYORDOMO O CAPATAZ FARM,LABORER,FOREMAN	3	3	-	3	2	1	5	5	-	5	5	-	20	20	-
OBRERO,EXC.FNCA,MINA LABORER,EX.FARM,MINE	83	82	1	87	85	2	97	95	2	101	100	1	106	106	-
ESTUDIANTES STUDENTS	2	-	2	2	2	-	1	-	1	1	1	-	1	1	-
SIN ESPECIFICAR UNSPECIFIED	182	88	94	202	84	118	211	64	147	239	74	165	343	62	281

TABLA - 9 DEFUNCIONES POR OCUPACION, GRUPOS DE EDAD Y SEXO  
 TABLE - 9 DEATHS BY OCCUPATION, AGE GROUPS AND SEX  
 PUERTO RICO, 1999

Pag 3 de 4

OCUPACION - OCCUPATION	55 - 59			60 - 64			65 - 69			70 - 74		
	TOTAL	HOMBRES - MALES	MUJERES - FEMALES	TOTAL	HOMBRES - MALES	MUJERES - FEMALES	TOTAL	HOMBRES - MALES	MUJERES - FEMALES	TOTAL	HOMBRES - MALES	MUJERES - FEMALES
<b>TOTAL</b>	<b>1,523</b>	<b>1,029</b>	<b>494</b>	<b>2,003</b>	<b>1,266</b>	<b>737</b>	<b>2,391</b>	<b>1,380</b>	<b>1,011</b>	<b>3,085</b>	<b>1,768</b>	<b>1,317</b>
PROFESIONALES,TECH. PROFESSIONAL,TECH & KINDRED WORKERS	86	57	29	117	79	38	140	90	50	176	118	58
MEDICOS Y DENTISTAS PHYSICIAN & DENTIST	4	4	-	3	3	-	7	7	-	11	10	1
AGRICULTORES Y ADM DE FINCAS FARMERS,FARM MANAGER	41	41	-	61	61	-	87	87	-	132	132	-
ADM.GERENTES,PROPIE- TARIOS EXCEPT FINCAS MANAGER,EXCEPT FARM	158	137	21	202	181	21	221	196	25	276	249	27
OFICINISTAS Y TRABA- JADORES AFINES CLERICAL & WORKERS	62	29	33	79	36	43	86	41	45	83	39	44
VENDEDORES SALES WORKERS	22	20	2	46	45	1	51	45	6	71	63	8
ARTESANOS,CAPATACES, TRABAJADORES AFINES CRAFTSMEN,& KINDRED WORKERS	185	182	3	205	203	2	214	209	5	285	280	5
OPERARIOS,TRAB.AFIN OPERATIVES AND KINDRED WORKERS	243	205	38	284	242	42	352	279	73	406	329	77
TRAB. DE SERVICIOS SERVICE WORKERS	229	173	56	285	220	65	300	218	82	379	288	91
OBRERO AGRICOLA Y MAYORDOMO O CAPATAZ FARM,LABORER,FOREMAN	24	24	-	40	39	1	50	50	-	82	81	1
OBRERO,EXC.FNCA,MINA LABORER,EX.FARM,MINE	94	94	-	110	108	2	121	120	1	131	129	2
ESTUDIANTES STUDENTS	-	-	-	-	-	-	-	-	-	-	-	-
SIN ESPECIFICAR UNSPECIFIED	375	63	312	571	49	522	762	38	724	1,053	50	1,003

TABLA - 9 DEFUNCIONES POR OCUPACION, GRUPOS DE EDAD Y SEXO  
 TABLE - 9 DEATHS BY OCCUPATION, AGE GROUPS AND SEX  
 PUERTO RICO, 1999

Pag 4 de 4

OCUPACION - OCCUPATION	75 - 79			80 - 84			85 y más			Sin Determinar		
	TOTAL	HOMBRES - MALES	MUJERES - FEMALES	TOTAL	HOMBRES - MALES	MUJERES - FEMALES	TOTAL	HOMBRES - MALES	MUJERES - FEMALES	TOTAL	HOMBRES - MALES	MUJERES - FEMALES
<b>TOTAL</b>	<b>3,577</b>	<b>1,989</b>	<b>1,588</b>	<b>3,800</b>	<b>1,918</b>	<b>1,882</b>	<b>6,537</b>	<b>2,904</b>	<b>3,633</b>	<b>9</b>	<b>8</b>	<b>1</b>
PROFESIONALES,TECH. PROFESSIONAL,TECH & KINDRED WORKERS	174	129	45	169	111	58	307	136	171	-	-	-
MEDICOS Y DENTISTAS PHYSICIAN & DENTIST	12	10	2	10	10	-	7	7	-	-	-	-
AGRICULTORES Y ADM DE FINCAS FARMERS,FARM MANAGER	215	215	-	287	286	1	697	693	4	-	-	-
ADM.GERENTES,PROPIE- TARIOS EXCEPT FINCAS MANAGER,EXCEPT FARM	322	286	36	335	295	40	506	439	67	-	-	-
OFICINISTAS Y TRABA- JADORES AFINES CLERICAL & WORKERS	97	56	41	91	44	47	131	59	72	-	-	-
VENDEDORES SALES WORKERS	66	64	2	58	55	3	79	69	10	-	-	-
ARTESANOS,CAPATACES, TRABAJADORES AFINES CRAFTSMEN,& KINDRED WORKERS	307	304	3	223	221	2	347	345	2	3	3	-
OPERARIOS,TRAB.AFIN OPERATIVES AND KINDRED WORKERS	403	307	96	389	314	75	518	354	164	-	-	-
TRAB. DE SERVICIOS SERVICE WORKERS	413	301	112	354	270	84	407	270	137	1	1	-
OBRERO AGRICOLA Y MAYORDOMO O CAPATAZ FARM,LABORER,FOREMAN	120	118	2	122	122	-	262	260	2	-	-	-
OBRERO,EXC.FNCA,MINA LABORER,EX.FARM,MINE	162	159	3	171	166	5	241	239	2	-	-	-
ESTUDIANTES STUDENTS	1	1	-	-	-	-	-	-	-	-	-	-
SIN ESPECIFICAR UNSPECIFIED	1,285	39	1,246	1,591	24	1,567	3,035	33	3,002	5	4	1

FUENTE: DEPARTAMENTO DE SALUD, SAPEESI, DIVISION DE ESTADISTICAS, SAN JUAN, PUERTO RICO.

SOURCE: DEPARTMENT OF HEALTH, ASPESIS, DIVISION OF STATISTICS, SAN JUAN, PUERTO RICO.

Tabla 10 - MUERTES FETALES POR MES Y SEXO  
Table 10 - FETAL DEATHS BY MONTH AND SEX  
PUERTO RICO, 1999

MES MONTH	1999				1998				1997			
	TOTAL	TASA RATE	HOMBRES MALES	MUJERES FEMALES	TOTAL	TASA RATE	HOMBRES MALES	MUJERES FEMALES	TOTAL	TASA RATE	HOMBRES MALES	MUJERES FEMALES
<b>TOTAL</b>	<b>* 684</b>	<b>0</b>	<b>354</b>	<b>328</b>	<b>* 692</b>	<b>0.1</b>	<b>362</b>	<b>324</b>	<b>* 708</b>	<b>0.1</b>	<b>372</b>	<b>329</b>
ENERO JANUARY	47	0	29	18	* 55	0.1	26	27	62	0.1	27	34
FEBRERO FEBRUARY	46	0	24	22	57	0.1	32	25	45	0.1	20	25
MARZO MARCH	* 56	0	23	32	61	0.1	29	32	* 43	0.1	22	21
ABRIL APRIL	54	0	34	20	47	0.1	27	20	41	0.1	22	19
MAYO MAY	54	0	30	24	48	0.1	26	22	57	0.1	37	20
JUNIO JUNE	67	0	27	40	* 59	0.1	29	28	56	0.1	28	26
JULIO JULY	45	0	29	16	64	0.1	38	26	74	0.2	39	35
AGOSTO AUGUST	70	0	43	27	57	0.1	29	28	70	0.1	38	31
SEPTIEMBRE SEPTEMBER	* 61	0	30	30	58	0.1	25	33	72	0.1	37	35
OCTUBRE OCTOBER	72	0	26	46	* 62	0.1	31	30	63	0.1	33	29
NOVIEMBRE NOVEMBER	55	0	32	23	* 68	0.2	43	24	74	0.1	40	33
DICIEMBRE DECEMBER	57	0	27	30	56	0.1	27	29	51	0.1	30	21

\*TOTAL INCLUYE SEXO NO ESPECIFICADO

TOTAL INCLUDES UNSPECIFIED SEX

FUENTE: DEPARTAMENTO DE SALUD, SAPEESI, DIVISION DE ESTADISTICAS, SAN JUAN, PUERTO RICO.

SOURCE: DEPARTMENT OF HEALTH, ASPESIS, DIVISION OF STATISTICS, SAN JUAN, PUERTO RICO.

Tabla 11 - MUERTES FETALES POR MUNICIPIO DE OCURRENCIA, MUNICIPIO DE RESIDENCIA Y TASA  
 Table 11 - FETAL DEATHS AND RATES BY MUNICIPALITIES OF RESIDENCE AND OCCURRENCE  
 PUERTO RICO, 1999

Pag 1 de 3

MUNICIPIOS MUNICIPALITIES	OCURRENCIA OCCURRENCE		RESIDENCIA RESIDENCE	
	NUMERO NUMBER	TASA RATE	NUMERO NUMBER	TASA RATE
<b>TOTAL</b>	<b>684</b>	<b>11.3</b>	<b>684</b>	<b>11.3</b>
REGION ARECIBO	69	9.3	74	10
AREA DE ARECIBO	39	9.8	45	11.3
ARECIBO	38	25.5	10	6.8
CAMUY	0	0	11	20.1
HATILLO	0	0	6	10.8
LARES	1	1.9	11	20.7
QUEBRADILLAS	0	0	3	7.6
UTUADO	0	0	4	8.3
AREA DE MANATI	30	8.7	29	8.4
BARCELONETA	0	0	1	2.8
CIALES	0	0	3	8.2
FLORIDA	0	0	2	9.9
MANATI	29	33.9	9	10.8
MOROVIS	0	0	2	3.4
VEGA BAJA	1	0.9	12	11
REGION BAYAMON	90	8.9	111	10.9
AREA BARRANQUITAS	0	0	16	7.2
BARRANQUITAS	0	0	4	8.4
COMERIO	0	0	4	15.3
COROZAL	0	0	3	5.5
NARANJITO	0	0	3	6
ORCOVIS	0	0	2	4.6
AREA DE BAYAMON	89	16.6	63	11.8
BAYAMON	88	24	45	12.4
TOA ALTA	1	1	12	11.3
VEGA ALTA	0	0	6	9.3
AREA DE CATAIO	1	0.4	32	12.2
CATAÑO	0	0	8	15.4
DORADO	1	1.7	6	10
TOA BAJA	0	0	18	12
REGION DE CAGUAS	82	9.2	91	10.1
AREA DE CAGUAS	48	10.5	44	9.6
AGUAS BUENAS	0	0	6	12
CAGUAS	48	20.8	19	8.3
GURABO	0	0	4	6.9
JUNCOS	0	0	10	17
SAN LORENZO	0	0	5	7.9
AREA DE CAYEY	13	7.4	18	10.3
AIBONITO	8	20.3	5	12.8
CAYEY	5	6.7	5	6.7
CIDRA	0	0	8	12.9

Tabla 11 - MUERTES FETALES POR MUNICIPIO DE OCURRENCIA, MUNICIPIO DE RESIDENCIA Y TASA  
 Table 11 - FETAL DEATHS AND RATES BY MUNICIPALITIES OF RESIDENCE AND OCCURRENCE  
 PUERTO RICO, 1999

Pag 2 de 3

MUNICIPIOS MUNICIPALITIES	OCURRENCIA OCCURRENCE		RESIDENCIA RESIDENCE	
	NUMERO NUMBER	TASA RATE	NUMERO NUMBER	TASA RATE
AREA DE HUMACAO	21	8	29	11
HUMACAO	21	22	8	8.5
LAS PIEDRAS	0	0	3	5.6
MAUNABO	0	0	7	36.5
NAGUABO	0	0	4	10.7
YABUCA	0	0	7	11.6
REGION MAYAGUEZ	48	10.4	51	11
AREA DE MAYAGUEZ	39	12.2	34	10.6
AÑASCO	0	0	7	16.2
CABO ROJO	0	0	3	4.4
HORMIGUEROS	0	0	3	13.9
LAS MARIAS	0	0	1	7.1
MARICAO	0	0	0	0
MAYAGUEZ	39	27.8	16	11.6
RINCON	0	0	4	16.1
AREA DE SAN GERMAN	9	6.3	17	11.9
LAJAS	0	0	3	8
SABANA GRANDE	0	0	8	18.6
SAN GERMAN	9	14.4	6	9.6
SUB REGION AGUADILLA	37	10.6	39	11.2
AGUADA	0	0	7	11.1
AGUADILLA	18	19.6	9	9.9
ISABELA	1	1.6	7	11.2
MOCA	17	24.7	5	7.4
SAN SEBASTIAN	1	1.6	11	17.1
REGION PONCE	138	13.7	136	13.5
AREA DE GUAYAMA	14	7.3	21	11
ARROYO	2	6.9	6	20.5
GUAYAMA	12	15.5	7	9.1
PATILLAS	0	0	4	13.5
SALINAS	0	0	4	7.2
AREA DE PONCE	114	18	91	14.5
ADJUNTAS	0	0	5	16.4
COAMO	0	0	7	10.4
JAYUYA	0	0	3	9.7
JUANA DIAZ	0	0	13	14.8
PONCE	114	35.8	51	16.3
SANTA ISABEL	0	0	7	15.3
VILLALBA	0	0	5	9.1
AREA DE YAUCO	10	5.4	24	12.9
GUANICA	0	0	3	9
GUAYANILLA	0	0	4	11.1
PEÑUELAS	0	0	5	10.4
YAUCO	10	14.7	12	17.5



Tabla 11 - MUERTES FETALES POR MUNICIPIO DE OCURRENCIA, MUNICIPIO DE RESIDENCIA Y TASA  
 Table 11 - FETAL DEATHS AND RATES BY MUNICIPALITIES OF RESIDENCE AND OCCURRENCE  
 PUERTO RICO, 1999

Pag 3 de 3

MUNICIPIOS MUNICIPALITIES	OCURRENCIA OCCURRENCE		RESIDENCIA RESIDENCE	
	NUMERO NUMBER	TASA RATE	NUMERO NUMBER	TASA RATE
REGION METROPOLITANA	217	16.4	155	11.8
AREA DE CAROLINA	29	5.6	57	11
CANOVANAS	1	1.2	9	10.8
CAROLINA	28	10.2	29	10.5
LOIZA	0	0	6	14.5
TRUJILLO ALTO	0	0	13	11
AREA DE SAN JUAN	188	23.2	98	12.2
GUAYNABO	0	0	14	9.4
SAN JUAN	188	28.4	84	12.9
SUB REGION FAJARDO	3	1.3	12	5.2
CEIBA	0	0	1	3.6
CULEBRA	0	0	0	0
FAJARDO	3	4.3	2	2.9
LUQUILLO	0	0	4	11.7
RIO GRANDE	0	0	5	5.9
VIEQUES	0	0	0	0
P R NO ESPECIFICADO	0	0	2	0
NO RESIDENTE	0	0	7	67.3
CANADA	0	0	0	0
CUBA	0	0	0	0
ESTADOS UNIDOS	0	0	0	0
GUAM	0	0	0	0
ISLAS VIRGENES	0	0	1	50
MEJICO	0	0	0	0
REPUBLICA DOMINICANA	0	0	1	142.9
OTROS PAISES	0	0	5	64.9
DESCONOCIDOS	0	0	6	200

FUENTE: DEPARTAMENTO DE SALUD, SAPEESI, DIVISION DE ESTADISTICAS, SAN JUAN, PUERTO RICO.

SOURCE: DEPARTMENT OF HEALTH, ASPESIS, DIVISION OF STATISTICS, SAN JUAN, PUERTO RICO.

# Mapa 3

## TASAS\* DE MORTALIDAD INFANTIL POR MUNICIPIOS PUERTO RICO, 1999

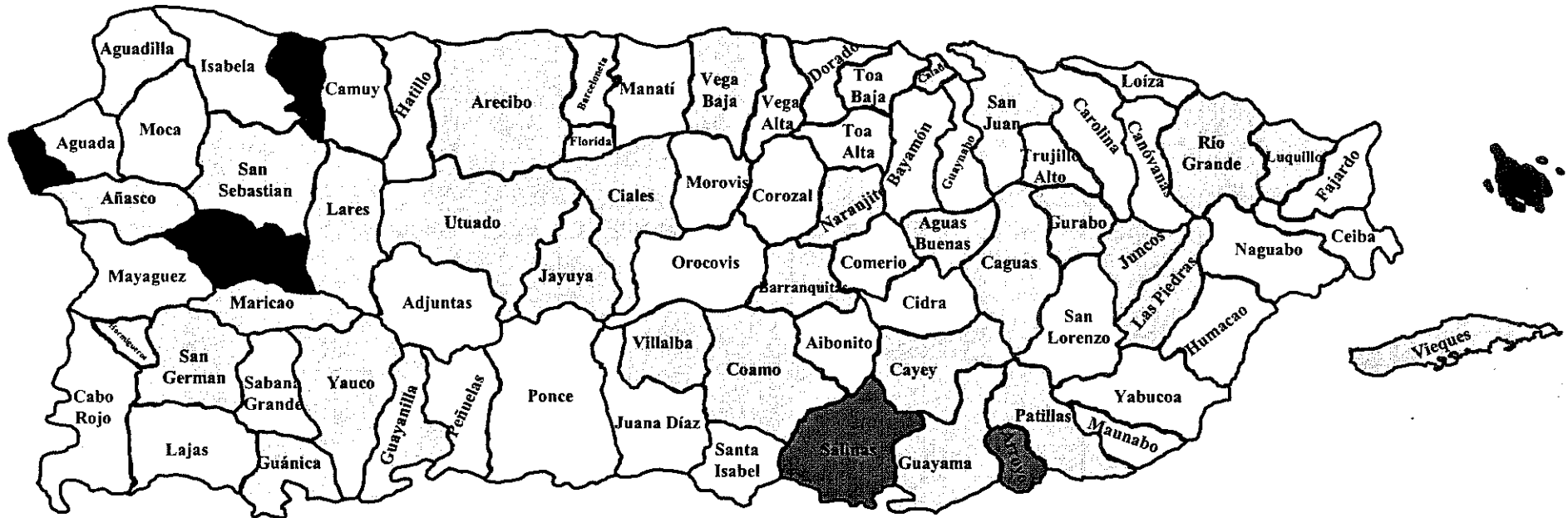

- Menos de 11.6 por 1000
- De 11.6 a 19.8 por 1000
- Más de 19.8 por 1000
- Sin muertes infantiles

\* TASAS POR 1,000 NACIDOS VIVOS, RATES PER 1,000 LIVE BIRTHS

FUENTE: DEPARTAMENTO DE SALUD, SAPEESI, DIVISION DE ESTADISTICAS, SAN JUAN, PUERTO RICO  
SOURCE: DEPARTMENT OF HEALTH, ASPESIS, DIVISION OF STATISTICS, SAN JUAN, PUERTO RICO

Tabla 12 - PRIMERAS DIEZ CAUSAS DE MORTALIDAD INFANTIL  
 Table 12 - FIRST TEN LEADING CAUSES OF INFANT MORTALITY  
 PUERTO RICO, 1999

CAUSAS DE MUERTE CAUSES OF DEATH	NUMERO NUMBER	POR CIENTO PERCENT	TASAS 1/ RATES
TODAS LAS CAUSAS ALL CAUSES	632	100.0	1,058.9
OTRAS CONDICIONES PERINATALES OTHER PERINATAL CONDITION	106	16.8	177.6
DESORDENES RELACIONADOS CON GETACION CORTA Y MALNUTRICION DISORDER RELATED TO LENGTH OF GETATION AND FETAL MALNUTRITION	97	15.3	162.5
MALFORMACIONES CONGENITAS, DEFORMIDADES Y ANOMALIAS CROMOSOMICAS CONGENITAL MALFORMATIONS, DEFORMATIONS AND CHROMOSOMAL ABNORMALITIES	75	11.9	125.7
SEPSIS BACTERIANA DEL RECIEN NACIDO BACTERIAL SEPSIS OF NEWBORN	55	8.7	92.2
OTROS TRASTORNOS RESPIRATORIOS ORIGINADOS EN EL PERIODO PERINATAL OTHER RESPIRATORY CONDITIONS ORIGINATING IN THE PERINATAL PERIOD	55	8.7	92.2
DIFICULTAD RESPIRATORIA DEL RECIEN NACIDO RESPIRATORY DISTRESS OF NEWBORN	51	8.1	85.5
OTROS Y SIN ESPECIFICAR PROBLEMAS RESPIRATORIOS OTHER AND UNSPECIFIED DISEASES OF RESPIRATORY SYSTEM	23	3.6	38.5
ENFERMEDADES DEL SISTEMA CIRCULATORIO DISEASES OF THE CIRCULATORY SYSTEM	19	3.0	31.8
SEPTICEMIA SEPTICEMIA	17	2.7	28.5
RECIEN NACIDO AFECTADO POR FACTORES MATERNAS Y POR COMPLICACIONES DEL EMBARAZO, PARTO Y ALUMBRAMIENTO NEWBORN AFFECTED BY MATERNAL FACTORS AND BY COMPLICATIONS OF PREGNANCY, LABOR AND DELIVERY	16	2.5	26.8
OTRAS CAUSAS OTHER CAUSES	118	18.7	197.7

1/ TASA POR 100,000 NACIDOS VIVOS

FUENTE: DEPARTAMENTO DE SALUD, SAPEESI, DIVISION DE ESTADISTICAS, SAN JUAN, PUERTO RICO.

SOURCE: DEPARTMENT OF HEALTH, ASPESIS, DIVISION OF STATISTICS, SAN JUAN, PUERTO RICO.

**Gráfica 13**  
**TASAS\* DE MORTALIDAD INFANTIL Y MORTINATOS**  
**POR AÑOS PUERTO RICO, 1960 - 1999**

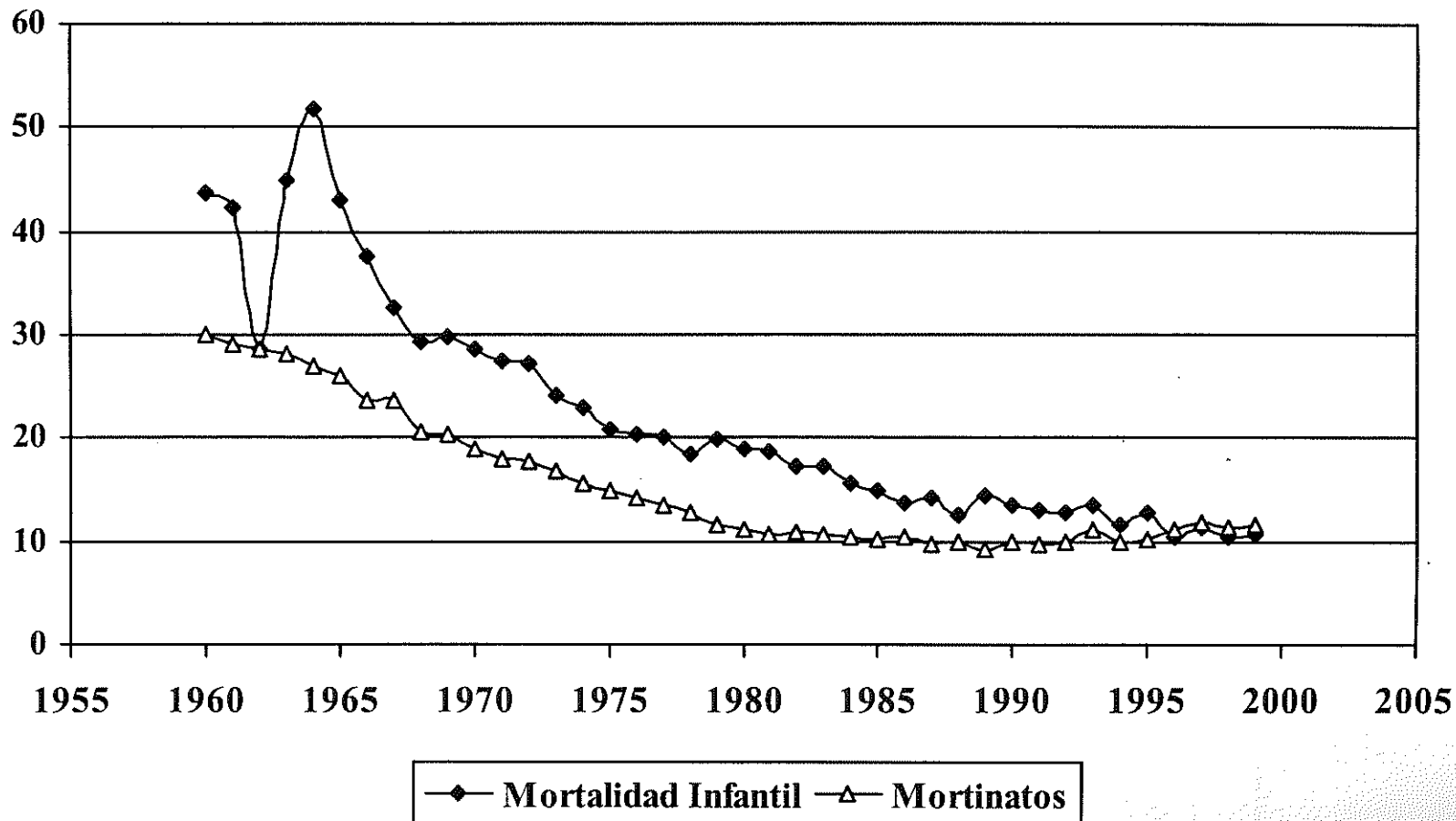

\* TASAS POR 1,000 NACIDOS VIVOS, RATES PER 1,000 LIVE BIRTHS  
 FUENTE: DEPARTAMENTO DE SALUD, SAPEESI, DIVISION DE ESTADISTICAS, SAN JUAN, PUERTO RICO  
 SOURCE: DEPARTMENT OF HEALTH, ASPESIS, DIVISION OF STATISTICS, SAN JUAN, PUERTO RICO

Tabla 13 - PRIMERAS DIEZ CAUSAS DE MORTALIDAD NEONATAL  
 Table 13 - FIRST TEN LEADING CAUSES OF NEONATAL MORTALITY  
 PUERTO RICO, 1999

CAUSAS DE MUERTE CAUSES OF DEATH	NUMERO NUMBER	POR CIENTO PERCENT	TASAS 1/ RATES
TODAS LAS CAUSAS ALL CAUSES	438	100.0	733.9
OTRAS CONDICIONES PERINATALES OTHER PERINATAL CONDITION	101	23.1	169.2
DESORDENES RELACIONADOS CON GESTACION CORTA Y MALNUTRICION DISORDERS RELATED LENGTH OF GESTATION AND FETAL MALNUTRITION	97	22.1	162.5
OTROS TRASTORNOS RESPIRATORIOS ORIGINADOS EN EL PERIODO PERINATAL OTHER RESPIRATORY CONDITION ORIGINATION IN PERINATAL PERIOD	51	11.6	85.5
DIFICULTAD RESPIRATORIA DEL RECIEN NACIDO RESPIRATORY DISTRESS OF NEWBORN	51	11.6	85.5
SEPSIS BACTERIANA DEL RECIEN NACIDO BACTERIAL SEPSIS OF NEWBORN	48	11.0	80.4
MALFORMACIONES CONGENITAS, DEFORMIDADES Y ANOMALIAS CROMOSOMICAS CONGENITAL MALFORMATIONS, DEFORMATION AND CHROMOSOMAL ABNORMALITIES	45	10.3	75.4
RECIEN NACIDO AFECTADO POR FACTORES MATERNAS Y POR COMPLICACIONES DEL EMBARAZO, PARTO Y ALUMBRAMIENTO NEWBORN AFFECTED BY MATERNAL FACTOR AND BY COMPLICATION OF PREGNANCY, LABOR AND DELIVERY	16	3.7	26.8
HIPOXIA INTRAUTERINA Y ASFIXIA EN EL NACIMIENTO INTRAUTERINE HYPOXIA AND BIRTH ASPHYXIA	10	2.3	16.8
CAUSAS EXTERNAS DE MORTALIDAD EXTERNAL CAUSES OF MORTALITY	3	0.7	5.0
DESORDENES HEMORRAGICOS Y HEMATOLOGICOS DEL RECIEN NACIDO HEMORRHAGIC AND HEMATOLOGICAL DISORDERS OF NEWBORN	3	0.7	5.0
OTRAS CAUSAS OTHER CAUSES	13	3.0	21.8

1/ TASA POR 100,000 NACIDOS VIVOS

FUENTE: DEPARTAMENTO DE SALUD, SAPEESI, DIVISION DE ESTADISTICAS, SAN JUAN, PUERTO RICO.

SOURCE: DEPARTMENT OF HEALTH, ASPESIS, DIVISION OF STATISTICS, SAN JUAN, PUERTO RICO.

Tabla 14 - PRIMERAS DIEZ CAUSAS DE MORTALIDAD POSTNEONATAL  
 Table 14 - FIRST TEN LEADING CAUSES OF POSNEONATAL MORTALITY  
 PUERTO RICO, 1999

CAUSAS DE MUERTE CAUSES OF DEATH	NUMERO NUMBER	POR CIENTO PERCENT	TASAS 1/ RATES
TODAS LAS CAUSAS ALL CAUSES	193	100.0	323.4
MALFORMACIONES CONGENITAS, DEFORMIDADES Y ANOMALIAS CROMOSOMICAS CONGENITAL MALFORMATIONS, DEFORMATIONS AND CHROMOSOMAL ABNORMALITIES	30	15.5	50.3
OTROS Y SIN ESPECIFICAR PROBLEMAS RESPIRATORIOS OTHER AND UNSPECIFIED DISEASES OF RESPIRATORY SYSTEM	23	11.9	38.5
ENFERMEDADES DEL SISTEMA CIRCULATORIO DISEASES OF THE CIRCULATORY SYSTEM	18	9.3	30.2
SEPTICEMIA SEPTICEMIA	17	8.8	28.5
INFLUENZA Y NEUMONIA INFLUENZA AND PNEUMONIA	14	7.3	23.5
ENFERMEDADES DEL SISTEMA DIGESTIVO DISEASES OF THE DIGESTIVE SYSTEM	9	4.7	15.1
ENFERMEDADES INFECCIOSAS Y PARASITARIAS INFECTIUOS AND PARASITIC DISEASES	9	4.7	15.1
SEPSIS BACTERIANA DEL RECIEN NACIDO BACTERIAL SEPSIS OF NEWBORN	7	3.6	11.7
ENFERMEDADES DE LA SANGRE Y DE LOS ORGANOS HEMATOPEYICOS DISEASES OF THE BLOOD AND BLOOD-FORMING ORGANS	7	3.6	11.7
SINDROME DE LA MUERTE SUBITA INFANTIL SUDDENT INFANT DEATH SYNDROME	6	3.1	10.1
OTRAS CAUSAS OTHER CAUSES	53	27.5	88.8

1/ TASA POR 100,000 NACIDOS VIVOS

FUENTE: DEPARTAMENTO DE SALUD, SAPEESI, DIVISION DE ESTADISTICAS, SAN JUAN, PUERTO RICO.

SOURCE: DEPARTMENT OF HEALTH, ASPESIS, DIVISION OF STATISTICS, SAN JUAN, PUERTO RICO.

Tabla 15 - MORTALIDAD MATERNA POR CAUSA Y GRUPOS DE EDAD  
 Table 15 - MATERNAL MORTALITY BY CAUSE AND AGE GROUPS  
 PUERTO RICO, 1999

CAUSA - CAUSE	TOTAL	< 15	15 - 19	20 - 24	25 - 29	30 - 34	35 - 39	40 - 44	45 - 49	50 +	SIN ESPEC UNSPEC
COMPLICACIONES DEL EMBARAZO, DEL PARTO Y DEL PUERPERIO (O00-O99) COMPLICATIONS OF PREGNANCY, CHILDIRTH AND THE PUERPERIUM	11	-	-	1	4	2	2	2	-	-	-
EMBARAZO TERMINADO EN ABORTO(O00-O07) PREGNANCY WITH ABORTIVE OUTCOME	3	-	-	-	1	1	-	1	-	-	-
EMBARAZO ECTOPICO (O00) ECTOPIC PRÉGNANCY	1	-	-	-	1	-	-	-	-	-	-
OTROS Y LOS NO ESPECIFICADOS EMBARAZOS TER- MINADOS EN ABORTO (O01-O02, O06-O07) OTHER AND UNSPECIFIED PREGNANCY WITH ABORTIVE OUTCOME	2	-	-	-	-	1	-	1	-	-	-
ECLAMPسيا Y PRE-ECLAMPسيا(O11,013-O16) ECLAMPسيا AND PRE-ECLAMPسيا	5	-	-	1	2	1	1	-	-	-	-
COMPLICACIONES PRINCIPALMENTE RELACIONADAS CON EL PUERPERIO (O85-O92) COMPLICATIONS PREDOMINANTLY RELATED TO PUERPERIUM	1	-	-	-	-	-	-	1	-	-	-
OTRAS COMPLICACIONES PRINCIPALMENTE RELACIONADAS CON EL PUERPERIO (O85-O87,O89-O92) OTHER COMPLICATIONS PREDOMINANTLY RELATED TO THE PUERPERIUM	1	-	-	-	-	-	-	1	-	-	-
TODAS LAS OTRAS CAUSAS OBSTETRICAS DIRECTAS (O10,O12,O21-O43,O47-O66,O68-O71,O73-O75) ALL OTHER DIRECT OBSTETRIC CAUSES	2	-	-	-	1	-	1	-	-	-	-

FUENTE: DEPARTAMENTO DE SALUD, SAPEESI, DIVISION DE ESTADISTICAS, SAN JUAN, PUERTO RICO.

SOURCE: DEPARTMENT OF HEALTH, ASPESIS, DIVISION OF STATISTICS, SAN JUAN, PUERTO RICO.

**Gráfica 14**  
**TASAS\* DE MORTALIDAD MATERNA POR AÑOS**  
**PUERTO RICO, 1960 - 1999**

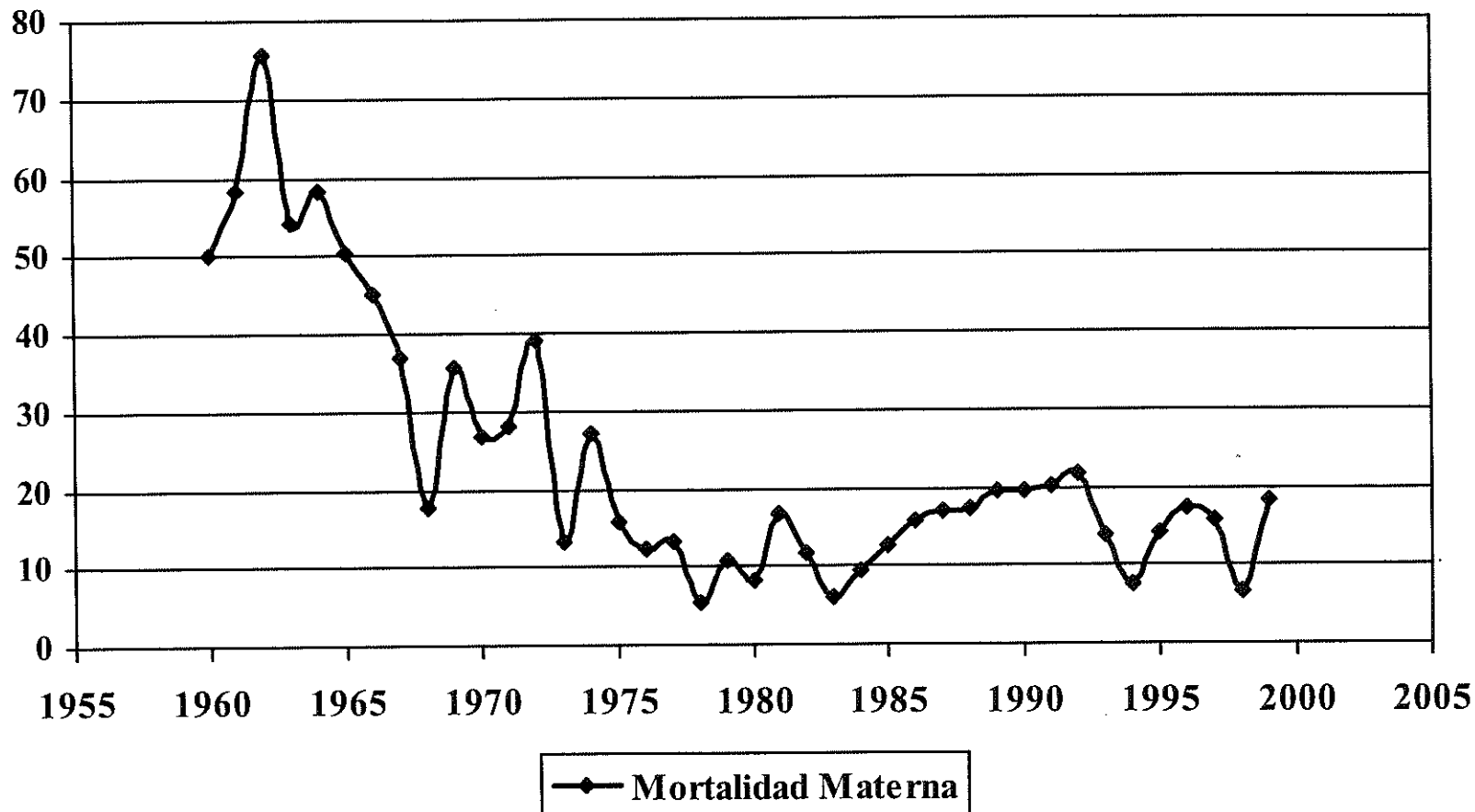

\* TASAS POR 100,000 NACIDOS VIVOS, RATES PER 1,000 LIVE BIRTHS  
 FUENTE: DEPARTAMENTO DE SALUD, SAPEESI, DIVISION DE ESTADISTICAS, SAN JUAN, PUERTO RICO  
 SOURCE: DEPARTMENT OF HEALTH, ASPESIS, DIVISION OF STATISTICS, SAN JUAN, PUERTO RICO



Tabla 16 - TASAS DE MORTALIDAD MATERNA POR MUNICIPIO DE RESIDENCIA Y OCURENCIA  
 Table 16 - MATERNAL MORTALITY RATES BY MUNICIPALITY OF RESIDENCE AND OCCURENCE  
 PUERTO RICO, 1999

MUNICIPIOS MUNICIPALITIES	OCURENCIA OCCURENCE		RESIDENCIA RESIDENCE	
	NUMERO NUMBER	TASA RATE	NUMERO NUMBER	TASA RATE
<b>TOTAL</b>	<b>11</b>	<b>18.4</b>	<b>11</b>	<b>18.4</b>
ARECIBO	-	-	1	30.4
ARROYO	-	-	1	609.8
CABO ROJO	1	148.6	-	-
CAGUAS	-	-	1	23.1
CAMUY	1	186.2	-	-
CAROLINA	2	73.3	-	-
CEIBA	1	359.7	-	-
FAJARDO	-	-	1	93.3
MAYAGUEZ	-	-	1	21.7
PATILLAS	1	342.5	-	-
PONCE	-	-	2	27.8
RIO GRANDE	1	119.3	-	-
SAN GERMAN	1	162.3	1	111
SAN JUAN	-	-	3	20.8
SANTA ISABEL	1	221.7	-	-
VILLALBA	1	184.2	-	-
YABUCOA	1	168.4	-	-

FUENTE: DEPARTAMENTO DE SALUD, SAPEESI, DIVISION DE ESTADISTICAS, SAN JUAN, PUERTO RICO.

SOURCE: DEPARTMENT OF HEALTH, ASPEESI, DIVISION OF STATISTICS, SAN JUAN, PUERTO RICO.

Gráfica 15

TASAS\* DE NUPCIALIDAD Y DIVORCIOS POR AÑOS  
PUERTO RICO, 1960 - 1999

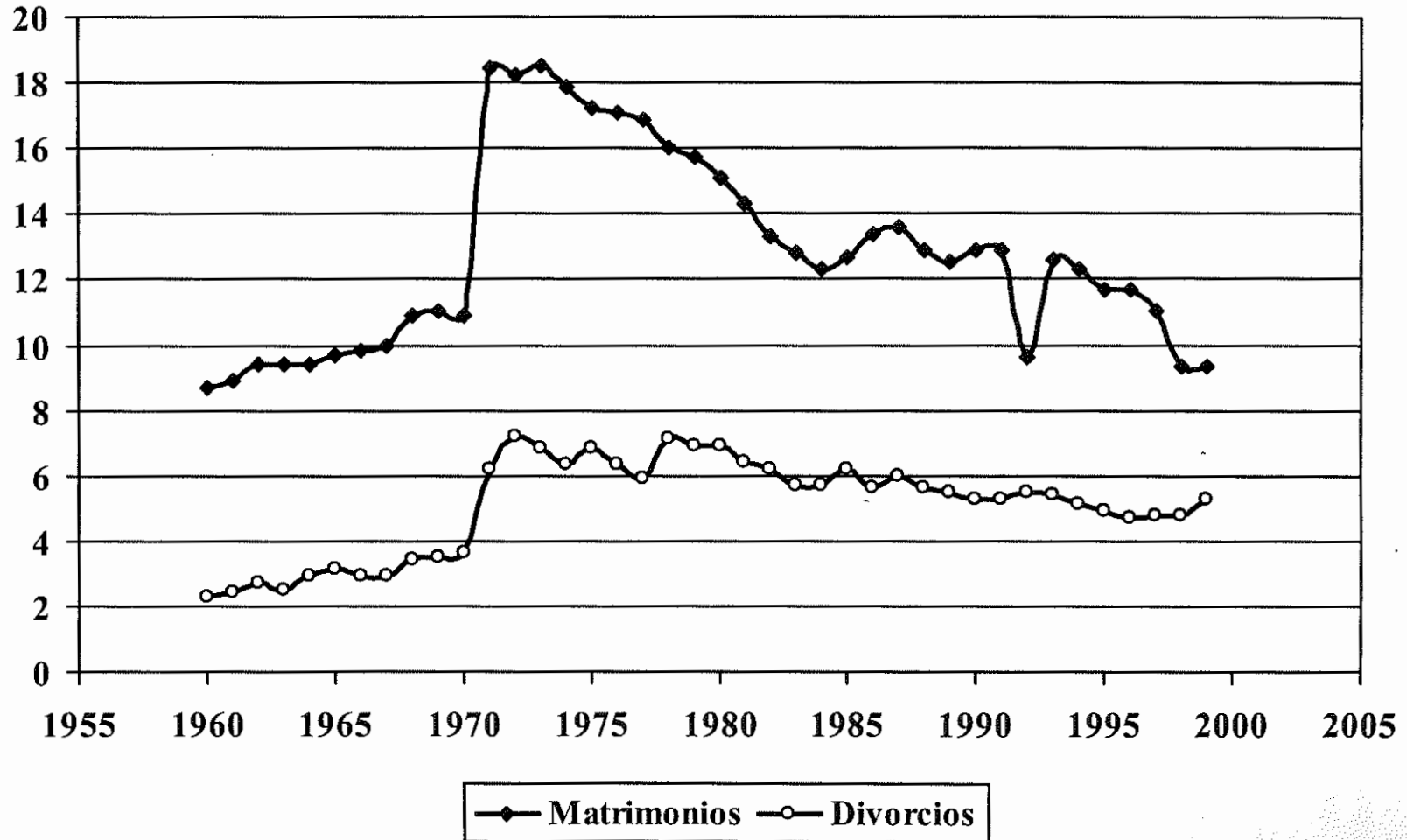

\* TASAS POR 1,000 HABITANTES DE 15 AÑOS O MAS

FUENTE: DEPARTAMENTO DE SALUD, SAPEESI, DIVISION DE ESTADISTICAS, SAN JUAN, PUERTO RICO

SOURCE: DEPARTMENT OF HEALTH, ASPESIS, DIVISION OF STATISTICS, SAN JUAN, PUERTO RICO

Tabla 17 - MATRIMONIOS POR EDAD DE LOS CONTRAYENTES  
Table 17 - MARRIAGES BY AGE OF BRIDE AND GROOM  
PUERTO RICO, 1999

EDAD DE LA CONTRAYENTE AGE OF THE BRIDE	EDAD DEL CONTRAYENTE - AGE OF GROOM											No Espec. Unspec.
	TOTAL	<15	15 - 19	20 - 24	25 - 29	30 - 34	35 - 39	40 - 44	45 - 49	50 - 54	55+	
TOTAL	27255	0	2115	8298	6538	3370	2090	1416	988	808	1632	0
< 15	133	0	67	54	8	4	0	0	0	0	0	0
15 - 19	4721	0	1467	2542	547	110	36	9	5	3	2	0
20 - 24	8420	0	493	4444	2526	657	185	72	25	12	6	0
25 - 29	5547	0	59	997	2500	1207	493	174	69	27	21	0
30 - 34	2929	0	23	194	682	889	588	313	131	59	50	0
35 - 39	1897	0	5	48	211	320	488	375	212	131	107	0
40 - 44	1247	0	1	17	46	136	205	276	262	154	150	0
45 - 49	851	0	0	2	10	35	68	120	176	201	239	0
50 - 54	600	0	0	0	5	9	21	56	61	149	299	0
55 +	910	0	0	0	3	3	6	21	47	72	758	0
NO ESPECIFICADA UNSPECIFIED	0	0	0	0	0	0	0	0	0	0	0	0

FUENTE: DEPARTAMENTO DE SALUD, SAPEESI, DIVISION DE ESTADISTICAS, SAN JUAN, PUERTO RICO.

SOURCE: DEPARTMENT OF HEALTH, ASPESIS, DIVISION OF STATISTICS, SAN JUAN, PUERTO RICO.

Tabla 18 - MATRIMONIOS POR PRIMERA VEZ POR EDAD DE LOS CONTRAYENTES  
Table 18 - FIRST MARRIAGE BY AGE OF BRIDE AND GROOM  
PUERTO RICO, 1999

EDAD DEL CONTRAYENTE AGE OF GROOM	EDAD DE LA CONTRAYENTE - AGE OF THE BRIDE											No Espec. Unspec.
	TOTAL	<15	15 - 19	20 - 24	25 - 29	30 - 34	35 - 39	40 - 44	45 - 49	50 - 54	55+	
TOTAL	17067	127	4429	7135	3534	1062	360	166	75	63	116	0
< 15	0	0	0	0	0	0	0	0	0	0	0	0
15 - 19	2043	66	1453	470	40	12	2	0	0	0	0	0
20 - 24	7567	51	2456	4157	784	103	11	5	0	0	0	0
25 - 29	4768	8	432	2038	1858	341	71	14	3	2	1	0
30 - 34	1572	2	69	380	651	349	84	32	5	0	0	0
35 - 39	560	0	17	63	162	181	96	35	4	1	1	0
40 - 44	218	0	1	21	31	50	62	34	12	5	2	0
45 - 49	96	0	0	4	6	16	12	28	19	4	7	0
50 - 54	79	0	0	2	1	6	14	13	15	17	11	0
55 +	164	0	1	0	1	4	8	5	17	34	94	0
NO ESPECIFICADA UNSPECIFIED	0	0	0	0	0	0	0	0	0	0	0	0

FUENTE: DEPARTAMENTO DE SALUD, SAPEESI, DIVISION DE ESTADISTICAS, SAN JUAN, PUERTO RICO.

SOURCE: DEPARTMENT OF HEALTH, ASPESIS, DIVISION OF STATISTICS, SAN JUAN, PUERTO RICO.

Tabla 19 - MATRIMONIOS POR EDAD Y ESTADO CIVIL PREVIO DE LOS CONTRAYENTES  
 Table 19 - MARRIAGES BY AGE AND PREVIOUS CIVIL STATUS OF BRIDE AND GROOM  
 PUERTO RICO, 1999

## DATOS DE LA CONTRAYENTE (BRIDE)

EDAD AGE	TOTAL	SOLTERA SINGLE	VIUDA WIDOW	DIVORCIADA DIVORCED	NO ESP. UNSP.
TOTAL	27255	20607	584	6064	0
< 15	133	132	0	1	0
15 - 19	4721	4682	3	36	0
20 - 24	8420	7967	6	447	0
25 - 29	5547	4481	38	1028	0
30 - 34	2929	1670	38	1221	0
35 - 39	1897	745	62	1090	0
40 - 44	1247	381	61	805	0
45 - 49	851	186	77	588	0
50 - 54	600	146	68	386	0
55 +	910	217	231	462	0
NO ESPECIFICADA UNSPECIFIED	0	0	0	0	0

## DATOS DEL CONTRAYENTE (GROOM)

EDAD AGE	TOTAL	SOLTERO SINGLE	VIUDO WIDOW	DIVORCIADO DIVORCED	NO ESP. UNSP.
TOTAL	27255	19363	588	7304	0
< 15	0	0	0	0	0
15 - 19	2115	2106	0	9	0
20 - 24	8298	7985	3	310	0
25 - 29	6538	5420	20	1098	0
30 - 34	3370	2013	22	1335	0
35 - 39	2090	851	27	1212	0
40 - 44	1416	376	38	1002	0
45 - 49	988	190	31	767	0
50 - 54	808	143	56	609	0
55 +	1632	279	391	962	0
NO ESPECIFICADA UNSPECIFIED	0	0	0	0	0

FUENTE: DEPARTAMENTO DE SALUD, SAPEESI, DIVISION DE ESTADISTICAS, SAN JUAN, PUERTO RICO.

SOURCE: DEPARTMENT OF HEALTH, ASPESES, DIVISION OF STATISTICS, SAN JUAN, PUERTO RICO.

Tabla 20 - DIVORCIOS CONCEDIDOS EN LAS SALAS DEL TRIBUNAL GENERAL DE JUSTICIA POR SALA Y CAUSAL  
 Table 20 - DIVORCES GRANTED BY CAUSES AT GENERAL JUSTICE TRIBUNAL COURTROOMS  
 PUERTO RICO, 1999

CAUSALES	Total	Aguadilla	Albionito	Arecibo	Bayamón	Caguas	Carolina	Fajardo	Guayama	Humacao	Mayagüez	Ponce	San Juan	Utua
<b>Total</b>	<b>15,527</b>	<b>1,713</b>	<b>631</b>	<b>1,194</b>	<b>1,404</b>	<b>1,610</b>	<b>1,516</b>	<b>468</b>	<b>580</b>	<b>377</b>	<b>1,745</b>	<b>1,228</b>	<b>2,235</b>	<b>826</b>
Consentimiento mutuo Mutual consent	7,792	930	169	724	372	987	962	274	303	63	819	540	1,244	405
Separación por más de dos años Separation for two or more years	4,517	492	254	268	596	351	299	98	174	210	615	392	490	278
Trato cruel Cruel treatment and graves injuries	2,714	262	187	173	370	223	208	73	90	82	259	264	407	116
Abandono por más de un año Abandonment for more than 1 year	346	23	20	18	38	34	36	11	10	14	34	16	70	22
Adulterio Adultery	91	5	1	2	17	10	7	5	2	1	14	10	16	1
Convicto a delito grave con pérdida derechos civiles Felony	15	0	0	0	4	2	0	2	1	0	0	3	3	0
Embriaguez habitual o uso continuo de narcóticos Habitual drunkenness or drugs	8	0	0	1	0	2	2	1	0	0	0	2	0	0
Exequatur Exequatur	44	1	0	8	7	1	2	4	0	7	4	1	5	4

Fuente: Administración de Tribunales, Oficina de Estadísticas, San Juan, Puerto Rico.

Tabla 21 - DIVORCIOS CONCEDIDOS EN LAS SALAS DEL TRIBUNAL GENERAL DE JUSTICIA POR MES Y CAUSAL  
 Table 21 - DIVORCES GRANTED AT GENERAL JUSTICE TRIBUNAL COURTROOMS BY CAUSES AND BY MONTH  
 PUERTO RICO, 1999

CAUSALES	Total	Enero	Febrero	Marzo	Abril	Mayo	Junio	Julio	Agosto	Septiembre	Octubre	Noviembre	Diciembre
<b>Total</b>	<b>15,527</b>	<b>1,147</b>	<b>1,429</b>	<b>1,410</b>	<b>1,363</b>	<b>1,362</b>	<b>1,529</b>	<b>857</b>	<b>1,263</b>	<b>1,365</b>	<b>1,398</b>	<b>1,044</b>	<b>1,360</b>
Consentimiento mutuo Mutual consent	7,792	574	742	724	745	683	755	442	657	675	664	489	642
Separación por más de dos años Separation for two or more years	4,517	351	392	417	364	391	449	249	377	411	409	304	403
Trato cruel Cruel treatment and graves injuries	2,714	184	254	235	214	239	274	143	190	249	262	214	256
Abandono por más de un año Abandonment for more than 1 year	346	26	29	28	25	30	33	16	28	19	43	26	43
Adulterio Adultery	91	8	8	5	12	13	8	5	5	3	13	3	8
Convicto a delito grave con pérdida derechos civiles Felony	15	1	0	1	1	4	3	0	1	2	0	0	2
Embriaguez habitual o uso continuo de narcóticos Habitual drunkenness or drugs	8	1	0	0	0	0	3	0	0	0	1	2	1
Exequatur Exequatur	44	2	4	0	2	2	4	2	5	6	6	6	5

Fuente: Administración de Tribunales, Oficina de Estadísticas, San Juan, Puerto Rico.

Tabla 22 - ESPERANZA DE VIDA AL NACER POR SEXO  
 Table 22 - LIFE EXPECTANCY AT BIRTH BY SEX  
 PUERTO RICO, 1902 - 1998

ANOS YEARS	HOMBRES MALES	MUJERES FEMALES	AMBOS SEXOS BOTH SEXES
1902	29.82	31.00	30.36
1910	37.72	38.64	38.17
1920	38.18	38.85	38.46
1930	40.07	41.46	40.65
1940	45.07	45.11	46.01
1950	59.45	62.43	60.85
1955	65.96	69.58	67.71
1960	67.14	71.88	69.36
1961	67.18	72.48	69.76
1962	66.68	72.37	69.45
1963	66.86	72.59	69.90
1966	67.49	73.11	70.18
1968	68.25	73.79	71.15
1970	68.96	75.18	71.97
1972	68.92	76.05	72.10
1973	69.03	75.63	72.24
1975	69.74	76.98	72.32
1976	70.21	77.11	73.52
1977	70.45	77.42	73.80
1978	70.91	77.59	74.06
1979	69.60	76.07	73.12
1980	69.88	76.87	73.11
1981	70.29	77.52	73.90
1982	70.53	77.39	73.91
1983	70.45	77.25	73.11
1984	70.26	77.28	73.64
1985	72.07	79.01	75.28
1986	70.70	78.94	74.74
1987	71.12	79.44	75.28
1988	70.14	79.57	74.21
1989	70.17	78.53	74.24
1990	69.74	78.50	74.05
1991	69.60	78.50	73.96
1992	69.33	78.80	75.18
1993	69.07	78.09	73.49
1994	68.83	77.87	73.27
1995	69.33	78.39	73.96
1996	69.57	78.29	74.04
1998	71.41	79.34	75.17

FUENTE: DEPARTAMENTO DE SALUD, SAPEESI, DIVISION DE ESTADISTICAS, SAN JUAN, PUERTO RICO.

SOURCE: DEPARTMENT OF HEALTH, ASPESES, DIVISION OF STATISTICS, SAN JUAN, PUERTO RICO.

**Gráfica 16**  
**ESPERANZA DE VIDA AL NACER**  
**PUERTO RICO: 1902 - 1998**

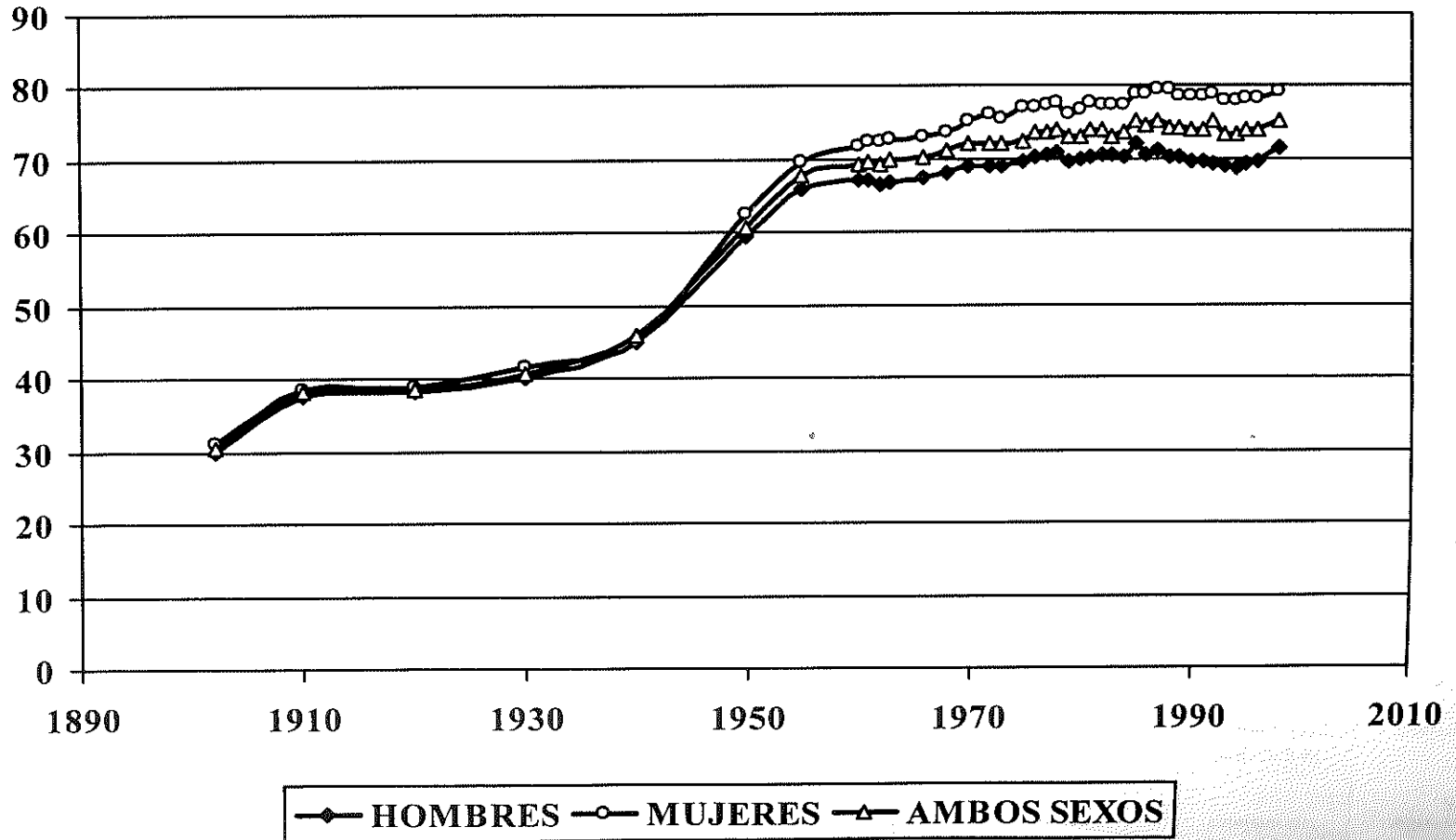

\* TASAS POR 100,000 HABITANTES RATES PER 100,000 POPULATION  
 FUENTE: DEPARTAMENTO DE SALUD, SAPEESI, DIVISION DE ESTADISTICAS, SAN JUAN, PUERTO RICO  
 SOURCE: DEPARTMENT OF HEALTH, ASPEESI, DIVISION OF STATISTICS, SAN JUAN, PUERTO RICO



**TABLA DE VIDA ABREVIADA PARA AMBOS SEXOS, 1997-99**  
**ABRIDGE LIFE TABLE FOR BOTH SEXES, 1997-99**  
**PUERTO RICO**

INTERVALO DE EDAD AGE INTERVAL	PROPORCION QUE FALLECE PROPORTION DYING	DE CADA 100,000 NACIDOS VIVOS OF 100,000 BORN ALIVE		POBLACION ESTACIONARIA STATIONARY POPULATION		EXPECTATIVA DE VIDA FUTURA PROMEDIO
		Sobrevivientes al comienzo de cada Intervalo	Número de fallecidos durante el Intervalo	En el Intervalo	En este Intervalo más en todos los subsiguientes	Promedio de años de vida que quedan a cada sobreviviente al comienzo del Intervalo
Periodo de la vida entre dos edades exactas (en años)	Proporción de fallecidos durante el intervalo	Number alive at beginning of age Interval	Number of dying during age Interval	In the age Interval	In the end all subsequent age Intervals	Average number of years of life remaining at beginning of age Interval
(1)	1.000000 o 100%	(3)	(4)	(5)	(6)	(7)
$x - (x + n)$	$nq_x$	$l_x$	$n^d_x$	$n^t_x$	$T_x$	$e_x$
0-1	0.01082	100,000	1,082	99,891	7,517,324	75.17
1-5	0.00127	98,918	126	395,170	7,417,434	74.99
5-10	0.00087	98,793	86	493,749	7,022,263	71.08
10-15	0.00116	98,707	114	493,249	6,528,514	66.14
15-20	0.00339	98,593	334	492,128	6,035,265	61.21
20-25	0.00617	98,258	606	489,778	5,543,138	56.41
25-30	0.00803	97,653	784	486,304	5,053,360	51.75
30-35	0.01009	96,869	978	481,900	4,567,056	47.15
35-40	0.01360	95,891	1,304	476,195	4,085,157	42.60
40-45	0.01747	94,587	1,652	468,802	3,608,962	38.16
45-50	0.02279	92,934	2,118	459,376	3,140,160	33.79
50-55	0.03105	90,816	2,820	447,031	2,680,784	29.52
55-60	0.04511	87,996	3,970	430,058	2,233,753	25.38
60-65	0.06601	84,027	5,547	406,267	1,803,694	21.47
65-70	0.09830	78,480	7,715	373,113	1,397,427	17.81
70-75	0.14310	70,765	10,127	328,510	1,024,314	14.47
75-80	0.21092	60,639	12,790	271,218	695,804	11.47
80-85	0.31551	47,849	15,097	201,501	424,586	8.87
85-90	0.45999	32,752	15,066	126,095	223,085	6.81
90-95	0.60008	17,613	10,613	61,898	96,990	5.48
95-100	0.69557	7,073	4,920	23,066	35,092	4.96
100-105	1.00000	2,153	2,153	12,026	12,026	5.58

Preparado por: Programa de Demografía, Escuela Graduada de Salud Pública, Recinto de Ciencias Médicas, Universidad de Puerto Rico.

TABLA DE VIDA ABREVIADA PARA VARONES, 1997-99  
 ABRIDGE LIFE TABLE FOR MALES, 1997-99  
 PUERTO RICO

INTERVALO DE EDAD AGE INTERVAL	PROPORCION QUE FALLECE PROPORTION DYING	DE CADA 100,000 NACIDOS VIVOS OF 100,000 BORN ALIVE		POBLACION ESTACIONARIA STATIONARY POPULATION		EXPECTATIVA DE VIDA FUTURA PROMEDIO
		Sobrevivientes al comienzo de cada Intervalo	Número de fallecidos durante el Intervalo	En el Intervalo	En este Intervalo más en todos los subsiguientes	Promedio de años de vida que quedan a cada sobreviviente al comienzo del Intervalo
Periodo de la vida entre dos edades exactas (en años)	Proporción de fallecidos durante el intervalo	Number alive at beginning of age Interval	Number of dying during age Interval	In the age Interval	In the end all subsequent age Intervals	Average number of years of life remaining at beginning of age Interval
(1)	1.000000 o 100%	(3)	(4)	(5)	(6)	(7)
$x - (x + n)$	$nq_x$	$l_x$	$n^d_x$	$n^L_x$	$T_x$	$e_x$
0-1	0.01142	100,000	1,142	98,974	7,140,618	71.41
1-5	0.00150	98,858	148	394,840	7,041,644	71.23
5-10	0.00092	98,710	91	493,322	6,646,804	67.34
10-15	0.00152	98,619	150	492,720	6,153,482	62.40
15-20	0.00520	98,469	512	491,065	5,660,762	57.49
20-25	0.01001	97,957	981	487,333	5,169,696	52.78
25-30	0.01273	96,976	1,235	481,795	4,682,363	48.28
30-35	0.01561	95,742	1,494	474,973	4,200,568	43.87
35-40	0.02114	94,247	1,992	466,257	3,725,595	39.53
40-45	0.02692	92,255	2,483	455,068	3,259,339	35.33
45-50	0.03474	89,772	3,119	441,063	2,804,271	31.24
50-55	0.04582	86,653	3,971	423,340	2,363,208	27.27
55-60	0.06473	82,683	5,352	400,032	1,939,868	23.46
60-65	0.08042	77,330	6,217	371,104	1,539,836	19.91
65-70	0.11568	71,111	8,226	334,991	1,168,732	16.44
70-75	0.16328	62,885	10,268	288,756	833,741	13.26
75-80	0.25841	52,617	13,597	229,094	544,986	10.36
80-85	0.36527	39,020	14,253	159,469	315,892	8.10
85-90	0.50304	24,767	12,459	92,690	156,422	6.32
90-95	0.63687	12,309	7,839	41,945	63,732	5.18
95-100	0.72692	4,470	3,249	14,225	21,787	4.87
100-105	1.00000	1,221	1,221	7,562	7,562	6.20

Preparado por: Programa de Demografía, Escuela Graduada de Salud Pública, Recinto de Ciencias Médicas, Universidad de Puerto Rico.

**TABLA DE VIDA ABREVIADA PARA MUJERES, 1997-99**  
**ABRIDGE LIFE TABLE FOR FEMALES, 1997-99**  
**PUERTO RICO**

INTERVALO DE EDAD AGE INTERVAL	PROPORCION QUE FALLECE PROPORTION DYING	DE CADA 100,000 NACIDOS VIVOS OF 100,000 BORN ALIVE		POBLACION ESTACIONARIA STATIONARY POPULATION		EXPECTATIVA DE VIDA FUTURA PROMEDIO
		Sobrevivientes al comienzo de cada Intervalo	Número de fallecidos durante el Intervalo	En el Intervalo	En este Intervalo más en todos los subsiguientes	AVERAGE REMAINING LIFETIME
Período de la vida entre dos edades exactas (en años) Period of life between two exact ages stated in years	Proporción de fallecidos durante el intervalo Proportion of persons alive at beginning of age Interval dying during Interval	Number alive at beginning of age Interval	Number of dying during age Interval	In the age Interval	In the end all subsequent age Intervals	Promedio de años de vida que quedan a cada sobreviviente al comienzo del Intervalo Average number of years of life remaining at beginning of age Interval
(1)	1.000000 o 100% (2)	(3)	(4)	(5)	(6)	(7)
$x - (x + n)$	$nq_x$	$l_x$	$n^d_x$	$n^t_x$	$T_x$	$e_x$
0-1	0.01018	100,000	1,018	99,085	7,933,811	79.34
1-5	0.00112	98,982	111	395,485	7,834,727	79.15
5-10	0.00081	98,871	80	494,156	7,439,242	75.24
10-15	0.00079	98,791	78	493,762	6,945,085	70.30
15-20	0.00144	98,714	142	493,213	6,451,323	65.35
20-25	0.00228	98,572	224	492,298	5,958,110	60.44
25-30	0.00338	98,347	333	490,905	5,465,812	55.58
30-35	0.00496	98,015	486	488,858	4,974,907	50.76
35-40	0.00698	97,528	680	485,940	4,486,050	46.00
40-45	0.00942	96,848	912	481,958	4,000,109	41.30
45-50	0.01276	95,936	1,224	476,616	3,518,151	36.67
50-55	0.01871	94,711	1,772	469,124	3,041,535	32.11
55-60	0.02883	92,939	2,680	457,994	2,572,411	27.68
60-65	0.04549	90,259	4,106	441,030	2,114,417	23.43
65-70	0.07248	86,153	6,245	415,153	1,673,387	19.42
70-75	0.11105	79,908	8,874	377,356	1,258,234	15.75
75-80	0.17362	71,034	12,333	324,338	880,878	12.40
80-85	0.27738	58,701	16,283	252,799	556,540	9.48
85-90	0.42942	42,418	18,215	166,554	303,741	7.16
90-95	0.57819	24,203	13,994	86,031	137,187	5.67
95-100	0.67665	10,209	6,908	33,776	51,156	5.01
100-105	1.00000	3,301	3,301	17,381	17,381	5.27

