

**ESTADO LIBRE ASOCIADO DE PUERTO RICO
DEPARTAMENTO DE SALUD**

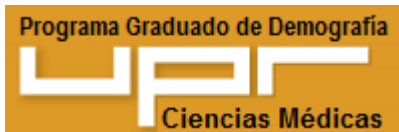

Estado Libre Asociado de Puerto Rico
Departamento de Salud



RESUMEN

DE ESTADÍSTICAS

VITALES 2001

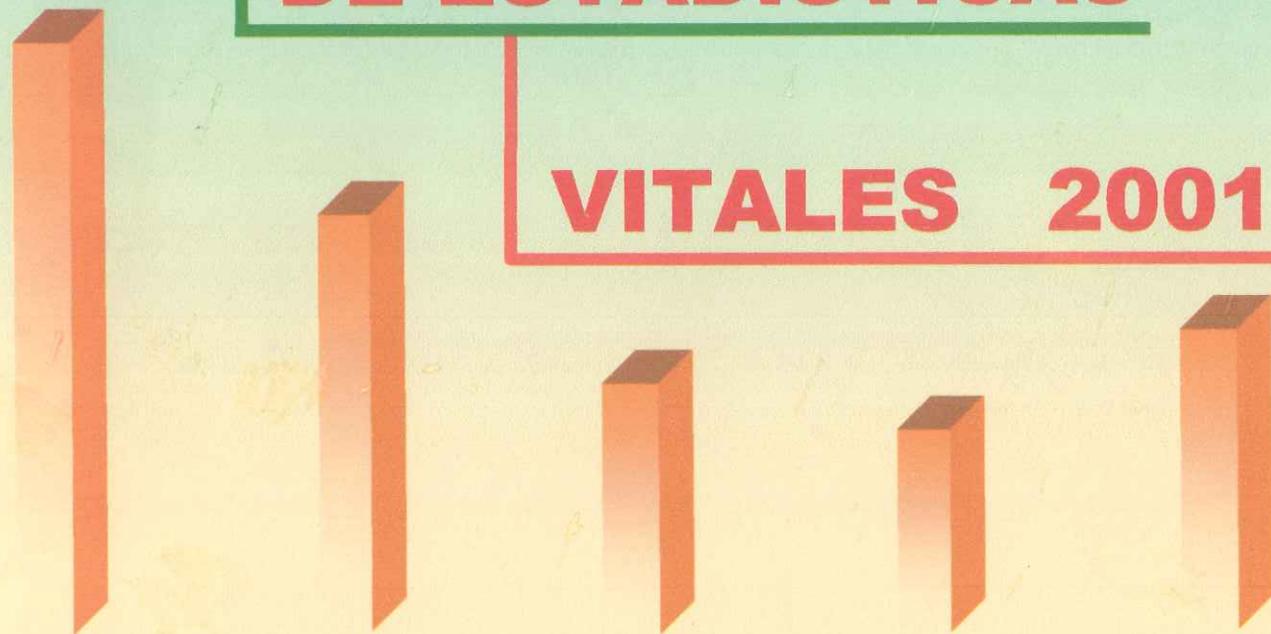

**Secretaría Auxiliar de Planificación, Evaluación,
Estadísticas y Sistemas de Información**

División de Estadísticas

ESTADO LIBRE ASOCIADO DE PUERTO RICO
DEPARTAMENTO DE SALUD
SECRETARIA AUXILIAR DE PLANIFICACIÓN,
EVALUACIÓN, ESTADÍSTICAS
Y SISTEMAS DE INFORMACIÓN

RESUMEN DE ESTADÍSTICAS
VITALES
PUERTO RICO, 2001

San Juan, Puerto Rico
Marzo de 2003

DEPARTAMENTO DE SALUD

JOHNNY RULLAN, M.D., FACPM
SECRETARIO DE SALUD

SECRETARÍA AUXILIAR DE PLANIFICACIÓN, EVALUACIÓN,
ESTADÍSTICAS Y SISTEMAS DE INFORMACIÓN

DALIDIA COLON PIERETTI
SECRETARIA AUXILIAR

Esta publicación fue preparada por:

Mario R. Zuleta Dávalos, Consultor en Demografía
Sonia M. González Cruz, Estadístico
Orlando Rosado Alcázar, Estadístico
Ivette Rolland Camacho, Estadístico
Yairellys Cruz Cruz, Oficinista Dactilógrafo
Ruth Arocho Santiago, Oficinista

Portada
Kenneth Torres Concepción

Los datos en este Informe son públicos, sin embargo, se requiere que, en caso de ser citados o divulgados, se reconozca apropiadamente la fuente de donde proviene la información.

Cita sugerida: Resumen de Estadísticas Vitales de Puerto Rico, 2001
Departamento de Salud, SAPEESI, San Juan, Puerto Rico

TABLA DE CONTENIDO

| | |
|---|----|
| INTRODUCCIÓN..... | 1 |
| DATOS SOBRESALIENTES | 6 |
| ESTADÍSTICAS DEMOGRÁFICAS GENERALES | 10 |
| NACIMIENTOS VIVOS..... | 17 |
| MORTALIDAD GENERAL..... | 23 |
| MUERTES FETALES..... | 39 |
| MORTALIDAD INFANTIL..... | 43 |
| MORTALIDAD MATERNA..... | 48 |
| MATRIMONIOS Y DIVORCIOS..... | 51 |

RESUMEN DE ESTADÍSTICAS VITALES PUERTO RICO, 2001

INTRODUCCIÓN

El Departamento de Salud, pone a disposición de las instituciones públicas, privadas y usuarios en general, el documento: Resumen de Estadísticas Vitales 2001. El mismo forma parte de la serie de documentos de Estadísticas Vitales que publica el Departamento de Salud con la finalidad de ofrecer información para un mayor conocimiento de la dinámica poblacional.

El documento contiene información de los nacimientos, matrimonios y defunciones inscritos en las oficinas del Registro Demográfico durante el año 2001, asimismo se presentan datos de los divorcios registrados en el mismo período.

Por otra parte, cabe mencionar que el Departamento de Salud se encuentra en proceso de actualización y fortalecimiento de los sistemas de producción de información en salud. El mismo, contempla entre otros, la implantación de la Décima Clasificación Internacional de Enfermedades (CIE-10). La mencionada clasificación está siendo utilizada a partir de 1999 en las publicaciones de Estadísticas Vitales.

Confiamos en que la información presentada en este documento sirva de insumo para estudios e investigaciones especiales que permitan conocer la situación social en general y del campo de la salud en particular.

EVENTOS VITALES PUERTO RICO, 2001

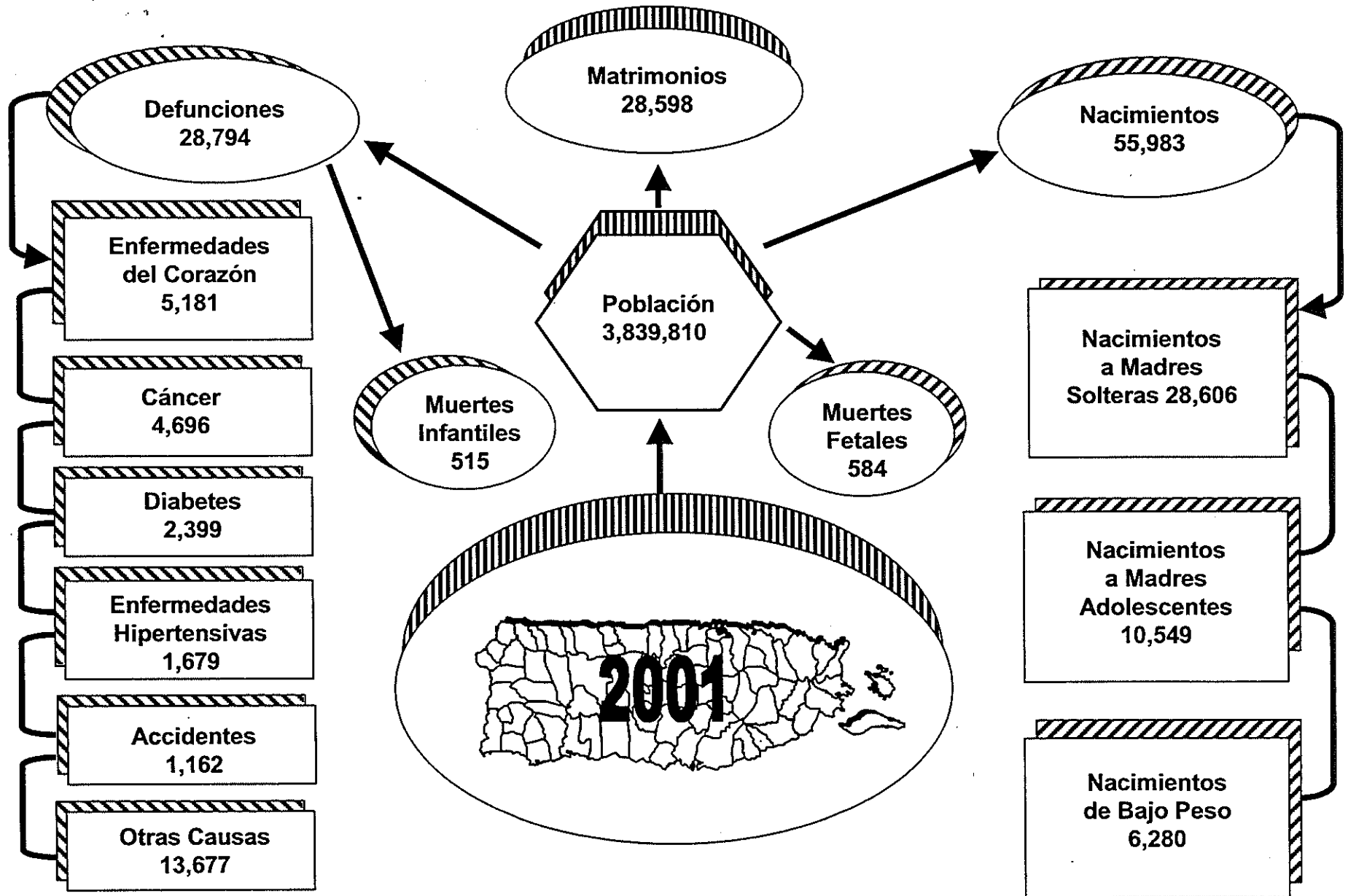

CADA DÍA EN 2001

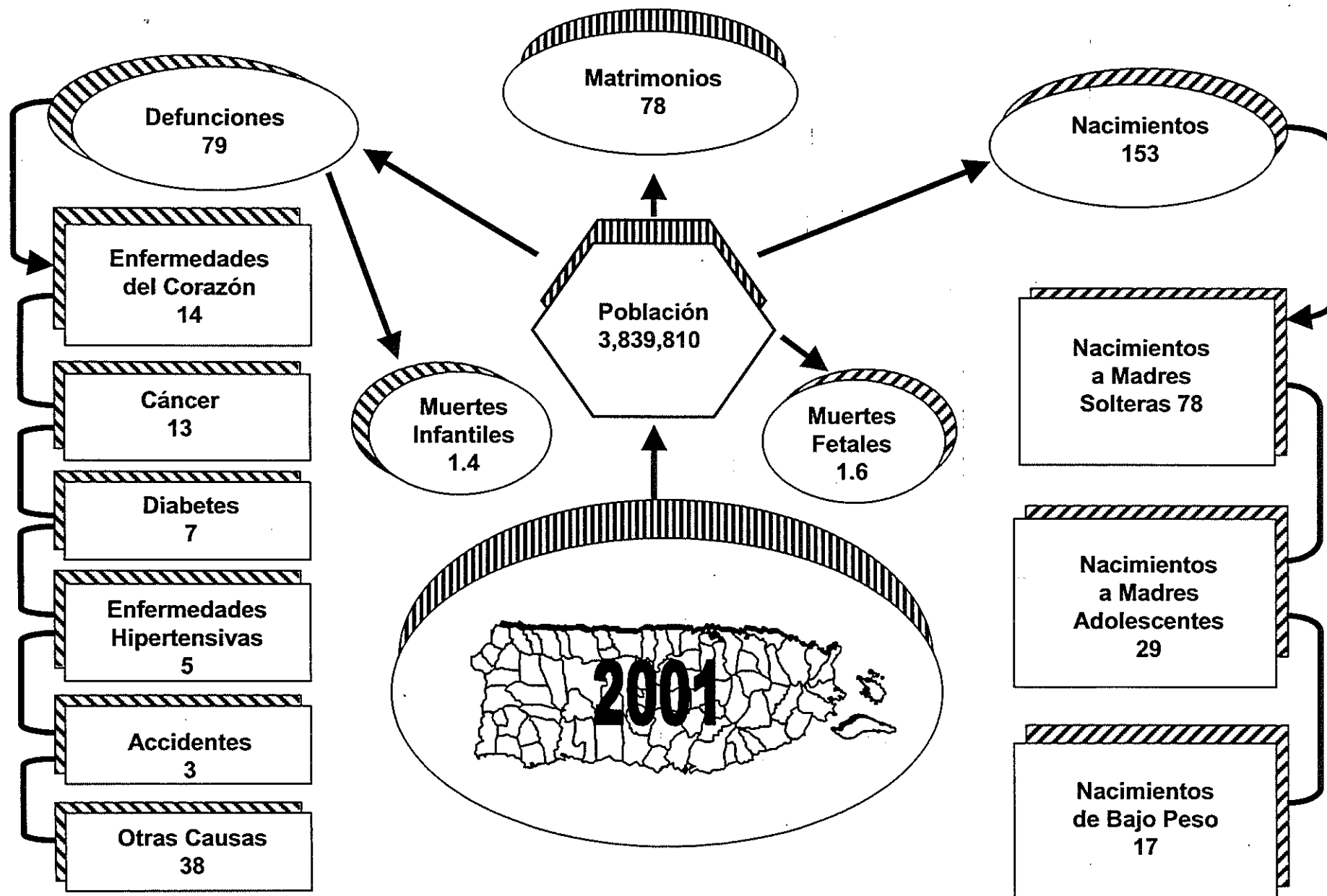

RESUMEN DEMOGRÁFICO

| Eventos y Tasas | 2001 | 2000 |
|----------------------------------|-----------|-----------|
| Población Total ¹ | 3,839,810 | 3,816,901 |
| Nacimientos | 55,983 | 59,460 |
| Tasa Bruta de Natalidad | 14.6 | 15.5 |
| Defunciones | 28,794 | 28,550 |
| Tasa Bruta de Mortalidad | 7.5 | 7.6 |
| Muertes Infantiles | 515 | 589 |
| Tasa de Mortalidad Infantil | 9.2 | 9.9 |
| Muertes Neonatales | 397 | 448 |
| Tasa de Mortalidad Neonatal | 7.1 | 7.5 |
| Muertes Postneonatales | 117 | 140 |
| Tasa de Mortalidad Postneonatal | 2.1 | 2.4 |
| Muertes Fetales | 584 | 651 |
| Tasa Mortalidad Fetal | 10.4 | 10.9 |
| Muertes Maternas | 5 | 12 |
| Tasa de Mortalidad Materna | 8.9 | 20.2 |
| Matrimonios | 28,598 | 25,980 |
| Tasa de Matrimonios ² | 7.4 | 8.9 |
| Divorcios | 13,870 | 13,621 |
| Tasa de Divorcios ² | 4.7 | 4.7 |

¹ Estimada por la Junta de Planificación al 1ro de julio.

² Tasa por 1,000 habitantes mayores de 15 años.

POBLACIÓN

La población estimada para Puerto Rico en el año 2001 fue de 3,839,810. Esta cifra representa un 0.6 por ciento más que la población estimada a julio de 2000 (3,816,901). Unas 27,189 personas se sumaron a la población total como resultado del crecimiento natural (la diferencia entre 55,983 nacimientos y 28,794 defunciones).

NACIMIENTOS

En el año 2001 hubo un total de 55,983 nacimientos. De estos, unos 55,877 nacimientos (99.8%) ocurrieron en hospitales; el 27.1 por ciento (15,135) en hospitales del gobierno y el 72.8 por ciento (40,742) en hospitales privados; 106 (0.2%) ocurrieron en el hogar y otros lugares.

Unos 6,280 nacimientos fueron de bajo peso al nacer (5 lbs. 8 oz. o menos), lo que representa una proporción de 11.2 por ciento. Para el año 2000, la proporción fue de 10.8 por ciento. La proporción de muy bajo peso (3 lbs. 4 oz. o menos) fue de 1.3 por ciento con 744 nacimientos (1.4% en el año 2000 con 854 nacimientos). Del total de nacimientos de bajo peso (6,280) el 23.1 por ciento (1,451) fueron de madres adolescentes.

Hubo 10,549 (18.8%) nacimientos a madres menores de 20 años (madres adolescentes). La proporción observada en el año 2000 fue de 19.2 por ciento (11,390 nacimientos) lo que refleja una reducción de 2.1 por ciento en los nacimientos a madres menores de 20 años.

El 51.1 por ciento (28,606) de los nacimientos fueron a madres solteras. Esta proporción fue de 49.7 por ciento en el año 2000 y continúa en aumento constante desde 1977, cuando fue de 18.6 por ciento. En el 75.6 por ciento de los nacimientos a madres adolescentes, éstas eran solteras (8,036 de 10,549).

En el 79.1 por ciento (44,275) de los nacimientos, las madres comenzaron el cuidado prenatal en el primer trimestre de embarazo. Esta proporción fue de 77.8 por ciento en el año 2000 (46,238).

Unos 23,536 nacimientos (42.0%) fueron por cesárea. Para el año 2000 estos nacimientos fueron 23,268 (39.1%) reflejando un aumento en los nacimientos por cesárea de 268 o 1.2 por ciento.

MORTALIDAD GENERAL

Las Enfermedades del Corazón y los Neoplasmas Malignos (Cáncer) fueron las dos principales causas de muerte, responsables en conjunto del 34.3 por ciento (9,877) del total de defunciones. Las Enfermedades del Corazón (18.0%) continúan siendo la primera causa de muerte. Unas 5,181 personas murieron por esta causa en este año mientras que para el año 2000 murieron 5,222 personas por esta misma causa.

Las Enfermedades Cardiovasculares (incluyendo aquí las enfermedades del corazón, cerebrovasculares, hipertensión y aterosclerosis), causaron 8,173 muertes, lo que equivale al 28.4 por ciento del total de muertes ocurridas.

Los Tumores Malignos (Cáncer) ocuparon el segundo lugar de las causas de muerte con 4,696 muertes, para un 16.3 por ciento del total de las muertes. Entre las mujeres hubo un total de 1,945 muertes por cáncer y entre los hombres hubo 2,751. Ocurrieron 535 muertes de Cáncer del Colon, 475 de Cáncer de Próstata y 336 de Cáncer de Mama.

La Diabetes Mellitus ocupó el tercer lugar (desde 1989 ocupa este lugar). Por esta causa murieron 2,399 personas, el 8.3 por ciento del total de muertes en el año 2001. En el año 2000 las muertes por esta causa fueron 2,273 (126 muertes menos que en el año 2001).

Las Enfermedades Hipertensivas ocuparon el cuarto lugar con 1,679 muertes equivalentes al 5.8 por ciento del total. Esta causa ocupó el mismo lugar con 1,575 muertes en el año 2000.

El quinto lugar es ocupado por las Enfermedades Cerebrovasculares con 1,197 muertes (4.2%). Esta causa ocupó el sexto lugar en el año 2000 con 1,166 muertes.

Todos los Accidentes ocupan el sexto lugar con 1,162 muertes (4.0%). Esta causa ocupó el quinto lugar con 1,321 muertes en el año 2000.

El séptimo lugar es ocupado por la Enfermedad Pulmonar Obstructiva Crónica (COPD por sus siglas en inglés), esta causó 1,147 defunciones (4.0%). Esta causa incluye las muertes por bronquitis, enfisema, asma, bronquiectasia, alveolitis alérgica y bronquiolitis. En el año 2000 ocupó el mismo lugar que en el año 2001 con 1,144 muertes.

El octavo lugar fue ocupado por Neumonía e Influenza que causaron 924 (3.2%) muertes. Esta causa ocupó el noveno lugar en el año 2000 y causó 785 (2.7%) muertes.

El noveno lugar fue ocupado por Alzheimer con 881 (3.1%). En el año 2000 esta causa ocupó el undécimo lugar con 709 (2.5%) muertes.

Las Enfermedades del Hígado ocupan el décimo lugar con 804 (2.8%) muertes. En el año 2000 esta causa ocupó el octavo lugar, causando 820 muertes (2.9%).

Nefritis y Nefrosis fueron la undécima causa con 774 (2.7%) muertes. Para el 2000 esta causa ocupó el décimo lugar con 777 (2.7%) muertes.

Los Homicidios e Intervención Legal ocuparon el duodécimo lugar con 752 (2.6%) muertes. En el año 2000, estos ocuparon el mismo lugar con 698 muertes.

La Infección por el Virus de Inmunodeficiencia Humana, virus causante del Síndrome de Inmunodeficiencia Adquirida (SIDA), ocupó el decimotercer lugar con 737 (2.6%) muertes. En el año 2000 ocupó el mismo lugar con 643 muertes.

Septicemia y las Enfermedades Originadas en el Período Perinatal ocuparon el decimocuarto y decimoquinto con 620 y 336 muertes, respectivamente.

MORTALIDAD INFANTIL

En el año 2001 ocurrieron 515 muertes infantiles con una tasa de 9.2 por cada mil nacimientos vivos. Se reportaron 74 muertes infantiles menos que en el 2000 (589 muertes infantiles).

De las 515 muertes de menores de un año ocurridas en Puerto Rico para el 2001, 397 ocurrieron en el período neonatal (menores de 28 días de vida) y 117 ocurrieron en el período postneonatal (desde los 28 días, pero sin lograr alcanzar su primer año). Se desconoce la edad exacta de un caso de mortalidad infantil.

MORTALIDAD FETAL Y MATERNA

Para el año 2001 se informaron 584 muertes fetales, lo que representa una tasa de 10.4 por cada mil nacidos vivos. La mortalidad fetal para el año 2001 se redujo en 67 muertes con relación a las muertes fetales reportadas para el año 2000 (651 muertes con una tasa de 10.8 por cada 1,000 nacidos vivos).

Las muertes maternas reportadas en el año 2001, fueron 5. Esto representa una tasa de 8.9 por cada 100,000 nacidos vivos. En el año 2000, se reportaron 12 muertes maternas con una tasa de 20.2 por cada 100,000 nacidos vivos.

MATRIMONIOS

Se celebraron 28,598 matrimonios, 2,618 más que en el año 2000 (25,980). La tasa de matrimonios por cada mil habitantes mayores de quince años fue de 9.7. Esta tasa para el año 2000 fue de 8.9. El mayor número de matrimonios se produjo en el grupo 20 a 24 años tanto para las mujeres como para los hombres, 8,554 y 7,893 respectivamente. Los matrimonios efectuados por primera vez fueron 17,589 (61.5%) del total de matrimonios. De estos, el grupo de edad con el mayor número de matrimonios correspondió al de 20 a 24 años para ambos sexos.

DIVORCIOS

Se informaron 13,870 divorcios, 249 divorcios más que el año anterior, lo que representa una tasa de 4.7 por cada mil habitantes de quince años o más. En el año 2000 se informaron 13,621 divorcios con una tasa de 4.7. Del total de divorcios concedidos, 7,027 (50.7%) fueron por consentimiento mutuo y 3,865 (27.9%) por separación por más de dos años. El mes con mayor número de divorcios concedidos fue el de marzo con 1,406 divorcios.

Tabla 1 - ESTADÍSTICAS DEMOGRÁFICAS EN PUERTO RICO POR AÑOS
Table 1 - DEMOGRAPHIC STATISTICS IN PUERTO RICO BY YEARS
PUERTO RICO, 2001

| Años Years | POBLACIÓN * POPULATION | Nacimientos Vivos Live Births | | Mortalidad General Total Deaths | | Mortalidad Infantil Infant Deaths | | Muertes Maternas Maternal Deaths | | Mortinatos Stillbirths | | Matrimonios Marriages | | Divorcios Divorces | |
|---------------|---------------------------|----------------------------------|---------|------------------------------------|---------|--------------------------------------|---------|-------------------------------------|---------|---------------------------|---------|--------------------------|---------|-----------------------|---------|
| | | Número | Tasa 1/ | Número | Tasa 1/ | Número | Tasa 2/ | Número | Tasa 3/ | Número | Tasa 2/ | Número | Tasa 4/ | Número | Tasa 4/ |
| 2001 | 3,839,810 | 55,983 | 14.6 | 28,794 | 7.5 | 515 | 9.2 | 5 | 8.9 | 584 | 10.4 | 28,598 | 7.4 | 13,870 | 4.7 |
| 2000 | 3,816,901 | 59,460 | 15.5 | 28,550 | 7.6 | 589 | 9.9 | 12 | 20.2 | 651 | 10.8 | 25,980 | 8.9 | 13,621 | 4.7 |
| 1999 | 3,886,425 | 59,684 | 15.4 | 29,145 | 7.5 | 632 | 10.6 | 11 | 18.4 | 684 | 11.5 | 27,255 | 9.3 | 15,527 | 5.3 |
| 1998 | 3,833,482 | 60,518 | 15.8 | 29,990 | 7.8 | 637 | 10.5 | 4 | 6.6 | 692 | 11.4 | 26,760 | 9.3 | 13,832 | 4.8 |
| 1997 | 3,805,003 | 64,214 | 16.9 | 29,119 | 7.7 | 729 | 11.4 | 10 | 15.6 | 740 | 11.7 | 31,480 | 11.0 | 13,737 | 4.8 |
| 1996 | 3,733,326 | 63,259 | 17.0 | 29,871 | 8.0 | 665 | 10.5 | 11 | 17.4 | 708 | 11.1 | 32,572 | 11.7 | 13,172 | 4.7 |
| 1995 | 3,719,317 | 63,518 | 17.0 | 30,196 | 8.1 | 809 | 12.7 | 9 | 14.2 | 650 | 10.1 | 32,514 | 11.7 | 13,648 | 4.9 |
| 1994 | 3,685,729 | 64,325 | 17.4 | 28,444 | 7.7 | 738 | 11.5 | 5 | 7.7 | 646 | 9.9 | 33,200 | 12.3 | 13,724 | 5.1 |
| 1993 | 3,621,538 | 65,242 | 18.0 | 28,494 | 7.9 | 874 | 13.4 | 9 | 13.8 | 734 | 11.1 | 33,262 | 12.6 | 14,198 | 5.4 |
| 1992 | 3,578,980 | 64,481 | 18.0 | 27,397 | 7.7 | 822 | 12.7 | 14 | 21.7 | 649 | 10.0 | 34,222 | 9.6 | 14,227 | 5.5 |
| 1991 | 3,549,160 | 64,516 | 18.2 | 26,328 | 7.4 | 841 | 13.0 | 13 | 20.2 | 631 | 9.7 | 33,222 | 12.9 | 13,571 | 5.3 |
| 1990 | 3,527,796 | 66,555 | 18.9 | 26,148 | 7.4 | 893 | 13.4 | 13 | 19.5 | 666 | 9.9 | 33,080 | 12.9 | 13,695 | 5.3 |
| 1989 | 3,497,287 | 66,692 | 19.1 | 25,987 | 7.4 | 952 | 14.3 | 13 | 19.5 | 620 | 9.2 | 31,642 | 12.5 | 13,838 | 5.5 |
| 1988 | 3,461,385 | 64,081 | 18.5 | 25,123 | 7.3 | 810 | 12.6 | 11 | 17.2 | 647 | 10.0 | 32,214 | 12.9 | 13,930 | 5.6 |
| 1987 | 3,433,345 | 64,393 | 18.8 | 23,954 | 7.0 | 916 | 14.2 | 11 | 17.1 | 626 | 9.6 | 33,285 | 13.6 | 14,611 | 6.0 |
| 1986 | 3,406,229 | 63,551 | 18.7 | 23,387 | 6.9 | 873 | 13.7 | 10 | 15.7 | 642 | 10.5 | 32,335 | 13.4 | 13,554 | 5.6 |
| 1985 | 3,378,126 | 63,629 | 18.8 | 23,194 | 6.9 | 947 | 14.9 | 8 | 12.6 | 657 | 10.2 | 30,306 | 12.7 | 14,686 | 6.2 |
| 1984 | 3,348,754 | 63,321 | 18.9 | 21,733 | 6.5 | 991 | 15.7 | 6 | 9.5 | 673 | 10.5 | 29,695 | 12.3 | 13,698 | 5.7 |
| 1983 | 3,321,848 | 65,742 | 19.8 | 21,499 | 6.5 | 1,140 | 17.3 | 4 | 6.1 | 710 | 10.7 | 29,632 | 12.8 | 13,164 | 5.7 |
| 1982 | 3,290,435 | 69,336 | 21.1 | 21,522 | 6.5 | 1,193 | 17.2 | 8 | 11.5 | 757 | 10.8 | 30,385 | 13.3 | 14,084 | 6.2 |
| 1981 | 3,251,847 | 71,365 | 21.9 | 21,197 | 6.5 | 1,325 | 18.6 | 12 | 16.8 | 775 | 10.7 | 31,916 | 14.3 | 14,247 | 6.4 |
| 1980 | 3,203,956 | 73,060 | 22.8 | 20,486 | 6.4 | 1,386 | 19.0 | 6 | 8.2 | 820 | 11.1 | 33,167 | 15.1 | 15,276 | 6.9 |
| 1979 | 3,160,700 | 73,781 | 23.3 | 20,390 | 6.5 | 1,469 | 19.9 | 8 | 10.8 | 854 | 11.6 | 33,768 | 15.7 | 14,791 | 6.9 |
| 1978 | 3,121,600 | 75,066 | 24.0 | 19,876 | 6.4 | 1,390 | 18.5 | 4 | 5.3 | 950 | 12.7 | 33,253 | 16.0 | 14,753 | 7.1 |
| 1977 | 3,074,100 | 75,151 | 24.4 | 19,895 | 6.5 | 1,507 | 20.1 | 10 | 13.3 | 1,007 | 13.4 | 34,541 | 16.9 | 12,085 | 5.9 |
| 1976 | 3,018,300 | 72,883 | 24.1 | 19,893 | 6.6 | 1,472 | 20.2 | 9 | 12.3 | 1,035 | 14.2 | 33,741 | 17.1 | 12,357 | 6.3 |
| 1975 | 2,938,800 | 69,691 | 23.7 | 19,073 | 6.5 | 1,455 | 20.9 | 11 | 15.8 | 1,047 | 15.0 | 32,731 | 17.2 | 12,905 | 6.8 |
| 1974 | 2,890,000 | 70,082 | 24.2 | 19,490 | 6.7 | 1,609 | 23.0 | 19 | 27.1 | 1,100 | 15.7 | 33,410 | 17.9 | 11,688 | 6.3 |
| 1973 | 2,872,300 | 68,821 | 24.0 | 19,257 | 6.7 | 1,667 | 24.2 | 9 | 13.1 | 1,158 | 16.8 | 34,221 | 18.5 | 12,593 | 6.8 |
| 1972 | 2,865,100 | 68,914 | 24.1 | 19,011 | 6.6 | 1,866 | 27.1 | 27 | 39.2 | 1,219 | 17.7 | 33,555 | 18.2 | 13,269 | 7.2 |
| 1971 | 2,779,300 | 71,117 | 25.6 | 18,144 | 6.5 | 1,957 | 27.5 | 20 | 28.1 | 1,280 | 18.0 | 32,069 | 18.4 | 10,770 | 6.2 |
| 1970 | 2,716,000 | 67,438 | 24.8 | 18,080 | 6.7 | 1,930 | 28.6 | 18 | 26.7 | 1,276 | 18.9 | 29,653 | 10.9 | 9,713 | 3.6 |
| 1969 | 2,706,000 | 67,577 | 25.0 | 17,669 | 6.5 | 2,005 | 29.7 | 24 | 35.5 | 1,367 | 20.2 | 29,741 | 11.0 | 9,509 | 3.5 |
| 1968 | 2,665,000 | 67,989 | 25.5 | 17,481 | 6.6 | 1,986 | 29.2 | 12 | 17.6 | 1,394 | 20.5 | 29,036 | 10.9 | 8,929 | 3.4 |
| 1967 | 2,634,000 | 70,755 | 26.9 | 16,780 | 6.4 | 2,317 | 32.7 | 26 | 36.7 | 1,673 | 23.6 | 26,406 | 10.0 | 7,728 | 2.9 |
| 1966 | 2,612,000 | 75,735 | 29.0 | 17,506 | 6.7 | 2,850 | 37.6 | 34 | 44.9 | 1,798 | 23.7 | 25,542 | 9.8 | 7,517 | 2.9 |
| 1965 | 2,583,000 | 79,586 | 30.8 | 17,719 | 6.9 | 3,421 | 43.0 | 40 | 50.3 | 2,072 | 26.0 | 25,184 | 9.7 | 8,035 | 3.1 |
| 1964 | 2,542,000 | 78,837 | 31.0 | 18,556 | 7.3 | 4,074 | 51.7 | 46 | 58.3 | 2,132 | 27.0 | 23,773 | 9.4 | 7,460 | 2.9 |
| 1963 | 2,491,000 | 77,382 | 31.1 | 17,386 | 7.0 | 3,467 | 44.8 | 42 | 54.3 | 2,186 | 28.2 | 23,465 | 9.4 | 6,309 | 2.5 |
| 1962 | 2,447,000 | 76,677 | 31.3 | 16,575 | 6.8 | 2,192 | 28.6 | 58 | 75.6 | 2,187 | 28.5 | 22,883 | 9.4 | 6,565 | 2.7 |

* Población al 1ro de julio. 1/ Tasas por 1,000 habitantes - Rates per 1,000 population. 2/ Tasas por 1,000 nacidos vivos. - Rates per 1,000 live births.

3/ Tasa por 100,000 nacidos vivos. - Rates per 100,000 live births. 4/ Tasas por 1,000 habitantes de 15 años o más - Rates per 1,000 population from fifteen years or more

FUENTE: DEPARTAMENTO DE SALUD, SAPEESI, DIVISIÓN DE ESTADÍSTICAS, SAN JUAN, PUERTO RICO

SOURCE: DEPARTMENT OF HEALTH, ASPEESI, DIVISION OF STATISTICS, SAN JUAN, PUERTO RICO

Gráfica 1 - TASAS* DE NATALIDAD Y MORTALIDAD POR AÑOS
Chart - 1 BIRTH AND DEATH RATES* BY YEARS
PUERTO RICO, 1960 - 2001

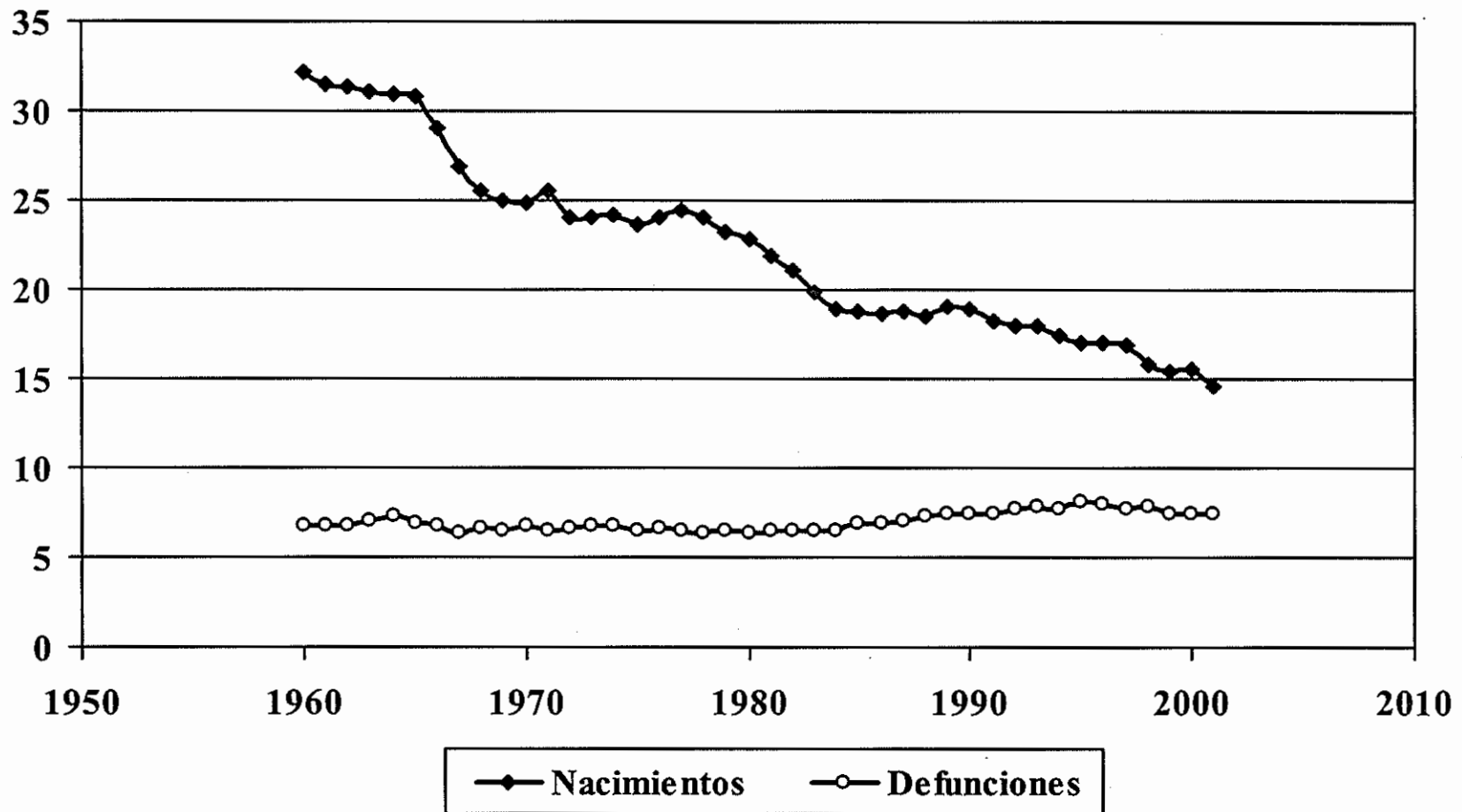

* TASAS POR 1,000 HABITANTES RATES PER 1,000 POPULATION
 FUENTE: DEPARTAMENTO DE SALUD, SAPEESI, DIVISI3N DE ESTADÍSTICAS, SAN JUAN, PUERTO RICO
 SOURCE: DEPARTMENT OF HEALTH, ASPESIS, DIVISION OF STATISTICS, SAN JUAN, PUERTO RICO

Tabla 2 - ESTADÍSTICAS DEMOGRÁFICAS POR REGIONES, ÁREAS DE SALUD Y MUNICIPIO
 Table 2 - DEMOGRAPHIC STATISTICS BY REGIONS, HEALTH AREAS AND MUNICIPALITY
 PUERTO RICO, 2001

Pag 1 de 4

| MUNICIPIOS MUNICIPALITIES | 1 | 2 | | 2 | | 3 | | 4 | | 3 | | 2 | |
|------------------------------|-------------------------|-------------------------------------|--------------|-----------------------|--------------|--|--------------|-------------------------------------|--------------|---------------------------|--------------|--------------------------|--------------|
| | POBLACIÓN POPULATION | NACIMIENTOS VIVOS LIVE BIRTHS | | DEFUNCIONES DEATHS | | MUERTES INFANTILES INFANT DEATHS | | MUERTE MATERNA MATERNAL DEATH | | MORTINATOS STILLBIRTHS | | MATRIMONIOS MARRIAGES | |
| | | NUM. NO. | TASA RATE | NUM. NO. | TASA RATE | NUM. NO. | TASA RATE | NUM. NO. | TASA RATE | NUM. NO. | TASA RATE | NUM. NO. | TASA RATE |
| TOTAL | 3,839,810 | 55,983 | 14.6 | 28,794 | 7.5 | 515 | 9.2 | 5 | 8.9 | 584 | 10.4 | 28,598 | 7.4 |
| REGION ARECIBO | 467,188 | 6,958 | 14.9 | 3,518 | 7.5 | 48 | 6.9 | 1 | 14.4 | 69 | 9.8 | 3,242 | 6.9 |
| AREA DE ARECIBO | 272,706 | 3,734 | 13.7 | 2,137 | 7.8 | 28 | 7.5 | 1 | 26.8 | 32 | 8.5 | 1,951 | 7.2 |
| ARECIBO | 100,842 | 1,371 | 13.6 | 856 | 8.5 | 9 | 6.6 | - | - | 14 | 10.1 | 714 | 7.1 |
| CAMUY | 35,959 | 479 | 13.3 | 273 | 7.6 | 1 | 2.1 | 1 | 208.8 | - | - | 264 | 7.3 |
| HATILLO | 39,618 | 528 | 13.3 | 297 | 7.5 | 2 | 3.8 | - | - | 7 | 13.1 | 294 | 7.4 |
| LARES | 35,016 | 466 | 13.3 | 252 | 7.2 | 2 | 4.3 | - | - | 2 | 4.3 | 224 | 6.4 |
| QUEBRADILLAS | 25,899 | 374 | 14.4 | 205 | 7.9 | 9 | 24.1 | - | - | 7 | 18.4 | 220 | 8.5 |
| UTUADO | 35,372 | 516 | 14.6 | 254 | 7.2 | 5 | 9.7 | - | - | 2 | 3.9 | 235 | 6.6 |
| AREA DE MANATI | 194,482 | 3,224 | 16.6 | 1,381 | 7.1 | 20 | 6.2 | - | - | 37 | 11.3 | 1,291 | 6.6 |
| BARCELONETA | 22,466 | 381 | 17.0 | 176 | 7.8 | - | - | - | - | 6 | 15.5 | 129 | 5.7 |
| CIALES | 19,994 | 296 | 14.8 | 155 | 7.8 | 3 | 10.1 | - | - | 3 | 10.0 | 159 | 8.0 |
| FLORIDA | 12,819 | 195 | 15.2 | 69 | 5.4 | 1 | 5.1 | - | - | 1 | 5.1 | 97 | 7.6 |
| MANATI | 46,154 | 734 | 15.9 | 344 | 7.5 | 6 | 8.2 | - | - | 8 | 10.8 | 384 | 8.3 |
| MOROVIS | 30,484 | 539 | 17.7 | 178 | 5.8 | 7 | 13.0 | - | - | 9 | 16.4 | 100 | 3.3 |
| VEGA BAJA | 62,565 | 1,079 | 17.2 | 459 | 7.3 | 3 | 2.8 | - | - | 10 | 9.2 | 422 | 6.7 |
| REGION BAYAMÓN | 628,003 | 9,371 | 14.9 | 4,231 | 6.7 | 84 | 9.0 | 2 | 21.3 | 88 | 9.3 | 3,894 | 6.2 |
| AREA BARRANQUITAS | 140,531 | 2,127 | 15.1 | 873 | 6.2 | 22 | 10.3 | - | - | 11 | 5.1 | 786 | 5.6 |
| BARRANQUITAS | 29,267 | 450 | 15.4 | 170 | 5.8 | 2 | 4.4 | - | - | 2 | 4.4 | 168 | 5.7 |
| COMERÍO | 19,962 | 288 | 14.4 | 133 | 6.7 | 6 | 20.8 | - | - | 1 | 3.5 | 103 | 5.2 |
| COROZAL | 37,272 | 572 | 15.3 | 247 | 6.6 | 6 | 10.5 | - | - | 5 | 8.7 | 194 | 5.2 |
| NARANJITO | 29,896 | 434 | 14.5 | 188 | 6.3 | 6 | 13.8 | - | - | 2 | 4.6 | 181 | 6.1 |
| OROCOVIS | 24,134 | 383 | 15.9 | 135 | 5.6 | 2 | 5.2 | - | - | 1 | 2.6 | 140 | 5.8 |
| AREA DE BAYAMÓN | 329,087 | 4,783 | 14.5 | 2,287 | 6.9 | 39 | 8.2 | 1 | 20.9 | 50 | 10.3 | 2,192 | 6.7 |
| BAYAMÓN | 224,432 | 3,252 | 14.5 | 1,696 | 7.6 | 27 | 8.3 | 1 | 30.8 | 35 | 10.6 | 1,600 | 7.1 |
| TOA ALTA | 66,388 | 936 | 14.1 | 327 | 4.9 | 5 | 5.3 | - | - | 10 | 10.6 | 308 | 4.6 |
| VEGA ALTA | 38,267 | 595 | 15.5 | 264 | 6.9 | 7 | 11.8 | - | - | 5 | 8.3 | 284 | 7.4 |
| AREA DE CATAÑO | 158,385 | 2,461 | 15.5 | 1,071 | 6.8 | 23 | 9.3 | 1 | 40.6 | 27 | 10.9 | 916 | 5.8 |
| CATAÑO | 29,451 | 504 | 17.1 | 219 | 7.4 | 4 | 7.9 | - | - | - | - | 248 | 8.4 |
| DORADO | 34,366 | 546 | 15.9 | 249 | 7.2 | 4 | 7.3 | - | - | 8 | 14.4 | 214 | 6.2 |
| TOA BAJA | 94,568 | 1,411 | 14.9 | 603 | 6.4 | 15 | 10.6 | 1 | 70.9 | 19 | 13.3 | 254 | 4.8 |

Tabla 2 - ESTADÍSTICAS DEMOGRÁFICAS POR REGIONES , ÁREAS DE SALUD Y MUNICIPIO
 Table 2 - DEMOGRAPHIC STATISTICS BY REGIONS, HEALTH AREAS AND MUNICIPALITY
 PUERTO RICO, 2001

| MUNICIPIOS MUNICIPALITIES | 1 | 2 | | 2 | | 3 | | 4 | | 3 | | 2 | |
|------------------------------|-------------------------|-------------------------------------|--------------|-----------------------|--------------|--|--------------|-------------------------------------|--------------|---------------------------|--------------|--------------------------|--------------|
| | POBLACIÓN POPULATION | NACIMIENTOS VIVOS LIVE BIRTHS | | DEFUNCIONES DEATHS | | MUERTES INFANTILES INFANT DEATHS | | MUERTE MATERNA MATERNAL DEATH | | MORTINATOS STILLBIRTHS | | MATRIMONIOS MARRIAGES | |
| | | NUM. NO. | TASA RATE | NUM. NO. | TASA RATE | NUM. NO. | TASA RATE | NUM. NO. | TASA RATE | NUM. NO. | TASA RATE | NUM. NO. | TASA RATE |
| REGIÓN DE CAGUAS | 575,603 | 8,455 | 14.7 | 3,987 | 6.9 | 81 | 9.6 | 1 | 11.8 | 83 | 9.7 | 3,862 | 6.7 |
| ÁREA DE CAGUAS | 287,081 | 4,193 | 14.6 | 2,000 | 7.0 | 39 | 9.3 | 1 | 23.8 | 39 | 9.2 | 1,939 | 6.8 |
| AGUAS BUENAS | 29,425 | 428 | 14.5 | 200 | 6.8 | 3 | 7.0 | - | - | 3 | 7.0 | 129 | 4.4 |
| CAGUAS | 141,239 | 2,128 | 15.1 | 1,011 | 7.2 | 22 | 10.3 | - | - | 24 | 11.2 | 1,094 | 7.7 |
| GURABO | 37,672 | 536 | 14.2 | 243 | 6.5 | 4 | 7.5 | - | - | 1 | 1.9 | 281 | 7.5 |
| JUNCOS | 37,104 | 582 | 15.7 | 248 | 6.7 | 3 | 5.2 | - | - | 2 | 3.4 | 213 | 5.7 |
| SAN LORENZO | 41,641 | 519 | 12.5 | 298 | 7.2 | 7 | 13.5 | 1 | 192.7 | 9 | 17.0 | 222 | 5.3 |
| ÁREA DE CAYEY | 117,660 | 1,794 | 15.2 | 793 | 6.7 | 18 | 10.0 | - | - | 15 | 8.3 | 679 | 5.8 |
| AIBONITO | 26,652 | 448 | 16.8 | 199 | 7.5 | 4 | 8.9 | - | - | - | - | 152 | 5.7 |
| CAYEY | 47,454 | 730 | 15.4 | 342 | 7.2 | 5 | 6.8 | - | - | 9 | 12.2 | 295 | 6.2 |
| CIDRA | 43,554 | 616 | 14.1 | 252 | 5.8 | 9 | 14.6 | - | - | 6 | 9.6 | 232 | 5.3 |
| ÁREA DE HUMACAO | 170,862 | 2,468 | 14.4 | 1,194 | 7.0 | 24 | 9.7 | - | - | 29 | 11.6 | 1,244 | 7.3 |
| HUMACAO | 59,438 | 875 | 14.7 | 447 | 7.5 | 7 | 8.0 | - | - | 11 | 12.4 | 500 | 8.4 |
| LAS PIEDRAS | 35,235 | 506 | 14.4 | 208 | 5.9 | 3 | 5.9 | - | - | 8 | 15.6 | 260 | 7.4 |
| MAUNABO | 12,782 | 176 | 13.8 | 98 | 7.7 | 4 | 22.7 | - | - | 1 | 5.6 | 64 | 5.0 |
| NAGUABO | 23,870 | 356 | 14.9 | 173 | 7.2 | 5 | 14.0 | - | - | 4 | 11.1 | 180 | 7.5 |
| YABUCOA | 39,537 | 555 | 14.0 | 268 | 6.8 | 5 | 9.0 | - | - | 5 | 8.9 | 240 | 6.1 |
| REGIÓN MAYAGÜEZ | 314,425 | 3,963 | 12.6 | 2,549 | 8.1 | 49 | 12.4 | - | - | 45 | 11.2 | 1,960 | 6.2 |
| ÁREA DE MAYAGÜEZ | 224,240 | 2,830 | 12.6 | 1,850 | 8.3 | 28 | 9.9 | - | - | 36 | 12.6 | 1,425 | 6.4 |
| ANASCO | 28,685 | 390 | 13.6 | 207 | 7.2 | 5 | 12.8 | - | - | 2 | 5.1 | 193 | 6.7 |
| CABO ROJO | 47,859 | 595 | 12.4 | 402 | 8.4 | 9 | 15.1 | - | - | 10 | 16.5 | 286 | 6.0 |
| HORMIGUEROS | 16,763 | 206 | 12.3 | 127 | 7.6 | 2 | 9.7 | - | - | 2 | 9.6 | 109 | 6.5 |
| LAS MARIAS | 11,256 | 140 | 12.4 | 75 | 6.7 | 2 | 14.3 | - | - | 5 | 34.5 | 61 | 5.4 |
| MARICAO | 6,474 | 81 | 12.5 | 42 | 6.5 | 1 | 12.3 | - | - | 1 | 12.2 | 39 | 6.0 |
| MAYAGÜEZ | 98,149 | 1,200 | 12.2 | 878 | 8.9 | 8 | 6.7 | - | - | 14 | 11.5 | 644 | 6.6 |
| RINCÓN | 15,054 | 218 | 14.5 | 119 | 7.9 | 1 | 4.6 | - | - | 2 | 9.1 | 93 | 6.2 |
| ÁREA DE SAN GERMAN | 90,185 | 1,133 | 12.6 | 699 | 7.8 | 21 | 18.5 | - | - | 9 | 7.9 | 535 | 5.9 |
| LAJAS | 26,585 | 323 | 12.1 | 188 | 7.1 | 4 | 12.4 | - | - | 5 | 15.2 | 121 | 4.6 |
| SABANA GRANDE | 26,271 | 346 | 13.2 | 217 | 8.3 | 6 | 17.3 | - | - | 1 | 2.9 | 141 | 5.4 |
| SAN GERMAN | 37,329 | 464 | 12.4 | 294 | 7.9 | 11 | 23.7 | - | - | 3 | 6.4 | 273 | 7.3 |

Tabla 2 - ESTADÍSTICAS DEMOGRÁFICAS POR REGIONES, ÁREAS DE SALUD Y MUNICIPIO
Table 2 - DEMOGRAPHIC STATISTICS BY REGIONS, HEALTH AREAS AND MUNICIPALITY
PUERTO RICO, 2001

Pag 3 de 4

| MUNICIPIOS MUNICIPALITIES | 1 POBLACIÓN POPULATION | 2 NACIMIENTOS VIVOS LIVE BIRTHS | | 2 DEFUNCIONES DEATHS | | 3 MUERTES INFANTILES INFANT DEATHS | | 4 MUERTE MATERNA MATERNAL DEATH | | 3 MORTINATOS STILLBIRTHS | | 2 MATRIMONIOS MARRIAGES | |
|------------------------------|------------------------------|--|--------------|----------------------------|--------------|---|--------------|--|--------------|--------------------------------|--------------|-------------------------------|--------------|
| | | NUM. NO. | TASA RATE | NUM. NO. | TASA RATE | NUM. NO. | TASA RATE | NUM. NO. | TASA RATE | NUM. NO. | TASA RATE | NUM. NO. | TASA RATE |
| | | SUB REGIÓN AGUADILLA | 238,243 | 3,147 | 13.2 | 1,824 | 7.7 | 25 | 7.9 | - | - | 38 | 11.9 |
| AGUADA | 42,719 | 585 | 13.7 | 258 | 6.0 | 1 | 1.7 | - | - | 5 | 8.5 | 260 | 6.1 |
| AGUADILLA | 65,253 | 769 | 11.8 | 541 | 8.3 | 2 | 2.6 | - | - | 16 | 20.4 | 579 | 8.9 |
| ISABELA | 45,020 | 601 | 13.3 | 392 | 8.7 | 5 | 8.3 | - | - | 5 | 8.3 | 314 | 7.0 |
| MOCA | 40,458 | 605 | 15.0 | 253 | 6.3 | 7 | 11.6 | - | - | 6 | 9.8 | 309 | 7.6 |
| SAN SEBASTIAN | 44,793 | 587 | 13.1 | 380 | 8.5 | 10 | 17.0 | - | - | 6 | 10.1 | 369 | 8.2 |
| REGIÓN PONCE | 597,007 | 9,228 | 15.5 | 4,575 | 7.7 | 72 | 7.8 | 1 | 10.8 | 98 | 10.5 | 3,766 | 6.3 |
| AREA DE GUAYAMA | 115,337 | 1,771 | 15.4 | 894 | 7.8 | 9 | 5.1 | - | - | 22 | 12.3 | 744 | 6.5 |
| ARROYO | 19,138 | 287 | 15.0 | 149 | 7.8 | 2 | 7.0 | - | - | 5 | 17.1 | 70 | 3.7 |
| GUAYAMA | 44,586 | 740 | 16.6 | 356 | 8.0 | 2 | 2.7 | - | - | 11 | 14.6 | 362 | 8.1 |
| PATILLAS | 20,204 | 269 | 13.3 | 174 | 8.6 | 2 | 7.4 | - | - | 1 | 3.7 | 168 | 8.3 |
| SALINAS | 31,409 | 475 | 15.1 | 215 | 6.8 | 3 | 6.3 | - | - | 5 | 10.4 | 144 | 4.6 |
| AREA DE PONCE | 362,317 | 5,707 | 15.8 | 2,785 | 7.7 | 47 | 8.2 | 1 | 17.5 | 60 | 10.4 | 2,280 | 6.3 |
| ADJUNTAS | 19,098 | 320 | 16.8 | 147 | 7.7 | 4 | 12.5 | - | - | 2 | 6.2 | 136 | 7.1 |
| COAMO | 38,001 | 565 | 14.9 | 302 | 7.9 | 7 | 12.4 | - | - | 6 | 10.5 | 175 | 4.6 |
| JAYUYA | 17,510 | 273 | 15.6 | 118 | 6.7 | 1 | 3.7 | - | - | 1 | 3.6 | 130 | 7.4 |
| JUANA DIAZ | 51,106 | 833 | 16.3 | 372 | 7.3 | 5 | 6.0 | - | - | 8 | 9.5 | 279 | 5.5 |
| PONCE | 186,286 | 2,841 | 15.3 | 1,507 | 8.1 | 25 | 8.8 | - | - | 38 | 13.2 | 1,316 | 7.1 |
| SANTA ISABEL | 21,918 | 409 | 18.7 | 189 | 8.6 | 4 | 9.8 | 1 | 244.5 | 3 | 7.3 | 97 | 4.4 |
| VILLALBA | 28,398 | 466 | 16.4 | 150 | 5.3 | 1 | 2.1 | - | - | 2 | 4.3 | 147 | 5.2 |
| AREA DE YAUCO | 119,353 | 1,750 | 14.7 | 896 | 7.5 | 16 | 9.1 | - | - | 16 | 9.1 | 742 | 6.2 |
| GUÁNICA | 22,091 | 281 | 12.7 | 189 | 8.6 | 3 | 10.7 | - | - | 3 | 10.6 | 121 | 5.5 |
| GUAYANILLA | 23,229 | 365 | 15.7 | 178 | 7.7 | 1 | 2.7 | - | - | 5 | 13.5 | 153 | 6.6 |
| PENUELAS | 27,186 | 469 | 17.3 | 177 | 6.5 | 3 | 6.4 | - | - | 6 | 12.6 | 130 | 4.8 |
| YAUCO | 46,847 | 635 | 13.6 | 352 | 7.5 | 9 | 14.2 | - | - | 2 | 3.1 | 338 | 7.2 |
| REGIÓN METROPOLITANA | 875,968 | 12,575 | 14.4 | 6,843 | 7.8 | 127 | 10.1 | - | - | 119 | 9.4 | 8,968 | 10.2 |
| AREA DE CAROLINA | 341,275 | 4,969 | 14.6 | 2,279 | 6.7 | 53 | 10.7 | - | - | 54 | 10.8 | 2,102 | 6.2 |
| CANÓVANAS | 44,058 | 749 | 17.0 | 302 | 6.9 | 6 | 8.0 | - | - | 10 | 13.2 | 284 | 6.4 |
| CAROLINA | 186,939 | 2,745 | 14.7 | 1,348 | 7.2 | 33 | 12.0 | - | - | 29 | 10.5 | 1,323 | 7.1 |
| LOÍZA | 32,884 | 430 | 13.1 | 177 | 5.4 | 7 | 16.3 | - | - | 4 | 9.2 | 138 | 4.2 |
| TRUJILLO ALTO | 77,394 | 1,045 | 13.5 | 452 | 5.8 | 7 | 6.7 | - | - | 11 | 10.4 | 357 | 4.6 |

Tabla 2 - ESTADÍSTICAS DEMOGRÁFICAS POR REGIONES , ÁREAS DE SALUD Y MUNICIPIO
 Table 2 - DEMOGRAPHIC STATISTICS BY REGIONS, HEALTH AREAS AND MUNICIPALITY
 PUERTO RICO, 2001

Pag 4 de 4

| MUNICIPIOS MUNICIPALITIES | 1 | 2 | | 2 | | 3 | | 4 | | 3 | | 2 | |
|------------------------------|-------------------------|-------------------------------------|--------------|-----------------------|--------------|--|--------------|-------------------------------------|--------------|---------------------------|--------------|--------------------------|--------------|
| | POBLACIÓN POPULATION | NACIMIENTOS VIVOS LIVE BIRTHS | | DEFUNCIONES DEATHS | | MUERTES INFANTILES INFANT DEATHS | | MUERTE MATERNA MATERNAL DEATH | | MORTINATOS STILLBIRTHS | | MATRIMONIOS MARRIAGES | |
| | | NUM. NO. | TASA RATE | NUM. NO. | TASA RATE | NUM. NO. | TASA RATE | NUM. NO. | TASA RATE | NUM. NO. | TASA RATE | NUM. NO. | TASA RATE |
| ÁREA DE SAN JUAN | 534,693 | 7,606 | 14.2 | 4,564 | 8.5 | 74 | 9.7 | - | - | 65 | 8.5 | 6,866 | 12.8 |
| GUAYNABO | 100,810 | 1,389 | 13.8 | 676 | 6.7 | 14 | 10.1 | - | - | 13 | 9.3 | 647 | 6.4 |
| SAN JUAN | 433,883 | 6,217 | 14.3 | 3,888 | 9.0 | 60 | 9.7 | - | - | 52 | 8.3 | 6,219 | 14.3 |
| SUB REGIÓN FAJARDO | 143,373 | 2,167 | 15.1 | 1,080 | 7.5 | 18 | 8.3 | - | - | 29 | 13.2 | 1,075 | 7.5 |
| CEIBA | 18,092 | 272 | 15.0 | 111 | 6.1 | - | - | - | - | 1 | 3.7 | 132 | 7.3 |
| CULEBRA | 1,905 | 27 | 14.2 | 11 | 5.8 | - | - | - | - | - | - | 10 | 5.2 |
| FAJARDO | 41,122 | 595 | 14.5 | 352 | 8.6 | 6 | 10.1 | - | - | 9 | 14.9 | 372 | 9.0 |
| LUQUILLO | 20,000 | 331 | 16.6 | 158 | 7.9 | 5 | 15.1 | - | - | 3 | 9.0 | 155 | 7.8 |
| RÍO GRANDE | 53,095 | 813 | 15.3 | 356 | 6.7 | 5 | 6.2 | - | - | 13 | 15.7 | 344 | 6.5 |
| VIEQUES | 9,159 | 129 | 14.1 | 92 | 10.0 | 2 | 15.5 | - | - | 3 | 22.7 | 62 | 6.8 |
| P R NO ESPECIFICADO | | - | - | - | - | - | - | - | - | - | - | - | - |
| DESCONOCIDO | | 20 | - | 31 | - | 1 | 50.0 | - | - | 11 | 354.8 | - | - |
| OTROS PAISES | | 99 | - | 156 | - | 10 | 101.0 | - | - | 1 | 14.1 | - | - |

(1) POBLACIÓN AL 1RO. DE JULIO 1999 - POPULATION AS OF JULY 1ST. 1999.

NACIMIENTOS, DEFUNCIONES, MUERTES INFANTILES Y MORTINATOS POR MUNICIPIO DE RESIDENCIA - LIVE BIRTHS, DEATHS, INFANT DEATHS, STILLBIRTHS BY MUNICIPALITY OF RESIDENCE.

MATRIMONIOS POR MUNICIPIO DE OCURRENCIA - MARRIAGES BY MUNICIPALITY OF OCCURRENCE.

(2) TASAS POR 1,000 HABITANTES - RATES PER 1,000 POPULATION.

(3) TASAS POR 1,000 NACIDOS VIVOS - RATES PER 1,000 LIVE BIRTHS.

(4) TASAS POR 100,000 NACIDOS VIVOS - RATES PER 100,000 LIVE BIRTHS.

FUENTE: DEPARTAMENTO DE SALUD, SAPEESI, DIVISIÓN DE ESTADÍSTICAS, SAN JUAN, PUERTO RICO

SOURCE: DEPARTMENT OF HEALTH, ASPESIS, DIVISION OF STATISTICS, SAN JUAN, PUERTO RICO

Mapa 1 - TASAS* DE NATALIDAD POR MUNICIPIOS
Map 1 - NATALITY RATES BY MUNICIPALITIES
PUERTO RICO, 2001

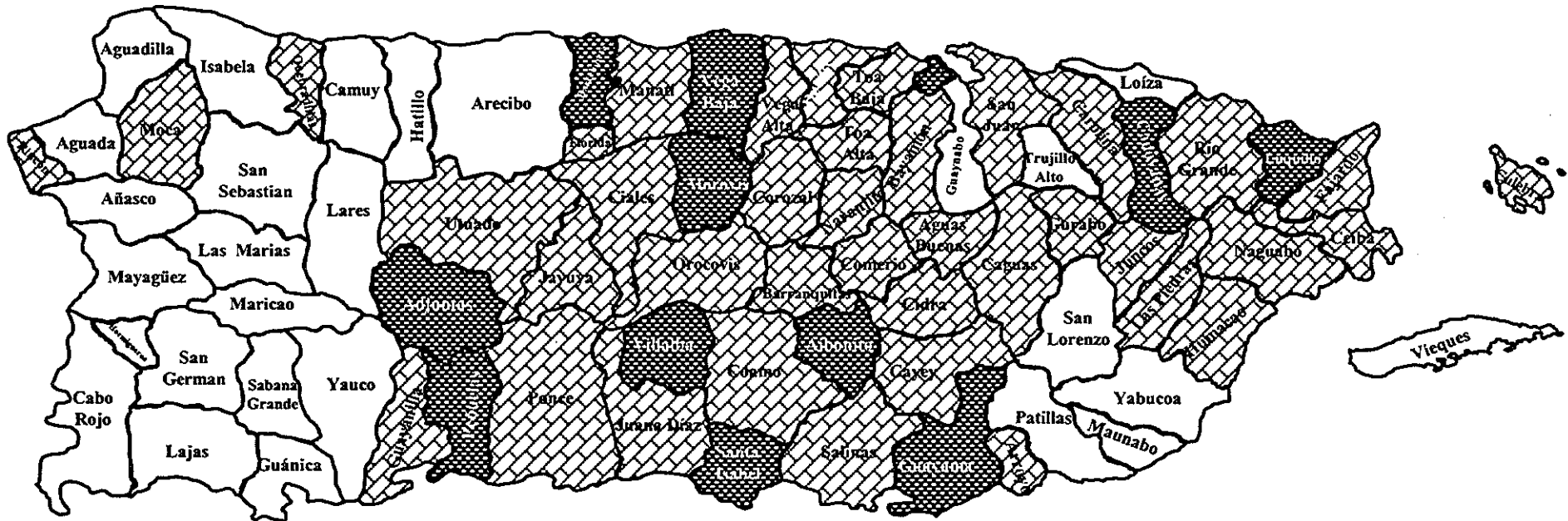

- Menos de 14.1 por 1000 - Less than 14.1 per 1000
- ▨ De 14.1 a 16.3 por 1000 - From 14.1 to 16.3 per 1000
- ▩ Más de 16.3 por 1000 - More than 16.3 per 1000

*TASAS POR 1,000 HABITANTES RATES PER 1,000 POPULATION
 FUENTE: DEPARTAMENTO DE SALUD, SAPEESI, DIVISION DE ESTADÍSTICAS, SAN JUAN, PUERTO RICO
 SOURCE: DEPARTMENT OF HEALTH, ASPEESI, DIVISION OF STATISTICS, SAN JUAN, PUERTO RICO

Tabla 3 - PERFIL DE LOS NACIMIENTOS EN HOSPITALES PÚBLICOS Y PRIVADOS
 Table 3 - PROFILE OF LIVE BIRTHS BY TYPE OF MEDICAL FACILITY
 PUERTO RICO, 2001

| CARACTERÍSTICAS SOBRESALIENTES IMPORTANT CHARACTERISTICS | TIPO DE HOSPITAL - TYPE OF MEDICAL FACILITY | | | | | | | |
|---|---|------------|---------|------------|---------|------------|---------------|------------|
| | TOTAL | | PÚBLICO | | PRIVADO | | OTROS LUGARES | |
| | Número | Por ciento | Número | Por ciento | Número | Por ciento | Número | Por ciento |
| TOTAL DE NACIMIENTOS OCURRIDOS TOTAL BIRTHS | 55,983 | 100 | 15,135 | 27.03 | 40,742 | 72.78 | 106 | 0.19 |
| EDAD DE LA MADRE - MOTHER'S AGE | | | | | | | | |
| MADRES ADOLESCENTES (<20) TEENAGE MOTHERS | 10,549 | 18.84 | 3,743 | 35.48 | 6,782 | 64.29 | 24 | 0.23 |
| MADRES MENORES DE 25 AÑOS MOTHERS < 25 | 18,408 | 32.88 | 5,383 | 29.24 | 12,989 | 70.56 | 36 | 0.2 |
| MADRES DE 25 A 29 AÑOS MOTHERS FROM 25 TO 29 | 14,083 | 25.16 | 3,358 | 23.84 | 10,698 | 75.96 | 27 | 0.13 |
| MADRES DE 30 AÑOS O MÁS MOTHERS > 30 | 12,900 | 23.04 | 2,641 | 20.47 | 10,240 | 79.38 | 19 | 0.15 |
| DESCONOCIDO UNSPECIFIED | 43 | 0.08 | 10 | 23.26 | 33 | 76.74 | 0 | 0 |
| NACIMIENTOS BAJO PESO LOW BIRTH WEIGHT BABIES | 6,280 | 11.22 | 2,324 | 37.01 | 3,927 | 62.53 | 29 | 0.46 |
| TRIMESTRE COMENZO CUIDADO PRENATAL - TRIMESTER PRENATAL CARE BEGAN | | | | | | | | |
| 1ER TRIMESTRE - 1ST TRIMESTER | 44,275 | 79.09 | 10,843 | 24.49 | 33,380 | 75.39 | 52 | 0.12 |
| 2DO TRIMESTRE - 2NO TRIMESTER | 9,689 | 17.31 | 3,433 | 35.43 | 6,243 | 64.43 | 13 | 0.13 |
| 3ER TRIMESTRE - 3RD TRIMESTER | 1,379 | 2.46 | 528 | 38.29 | 848 | 61.49 | 3 | 0.22 |
| NAC. SIN CUIDADO PRENATAL NO PRENATAL CARE | 445 | 0.79 | 294 | 66.07 | 120 | 26.97 | 31 | 6.97 |
| DESCONOCIDO - UNSPECIFIED | 195 | 0.35 | 37 | 18.97 | 151 | 77.44 | 7 | 3.59 |
| ESCOLARIDAD DE LA MADRE - MOTHER'S EDUCATION | | | | | | | | |
| MENOS DE 12 AÑOS DE ESCUELA LESS THAN 12 YEARS | 13,919 | 24.86 | 5,554 | 39.9 | 8,320 | 59.77 | 45 | 0.32 |
| 12 AÑOS DE ESCUELA 12 YEARS | 17,170 | 30.67 | 5,011 | 29.18 | 12,133 | 70.66 | 26 | 0.15 |
| 13 A 15 AÑOS DE ESCUELA 13 TO 15 YEARS | 12,938 | 23.11 | 3,039 | 23.49 | 9,881 | 76.37 | 18 | 0.14 |
| 16 AÑOS DE ESCUELA O MAS 16 YEARS OR MORE | 11,791 | 21.06 | 1,480 | 12.55 | 10,295 | 87.31 | 16 | 0.14 |
| DESCONOCIDO UNSPECIFIED | 165 | 0.29 | 51 | 30.91 | 113 | 68.48 | 1 | 0.61 |
| NACIMIENTOS A MADRES SOLTERAS BIRTHS TO UNMARRIED MOTHERS | 28,606 | 51.1 | 9,157 | 32.01 | 19,372 | 67.72 | 77 | 0.27 |

FUENTE: DEPARTAMENTO DE SALUD, SAPEESI, DIVISIÓN DE ESTADÍSTICAS, SAN JUAN, PR.

SOURCE: DEPARTMENT OF HEALTH, ASPESIS, DIVISION OF STATISTICS, SAN JUAN, PR.

Gráfica 2 - NACIMIENTOS VIVOS POR EDAD DE LA MADRE
Chart 2 - LIVE BIRTH BY MOTHERS AGE
PUERTO RICO, 2001

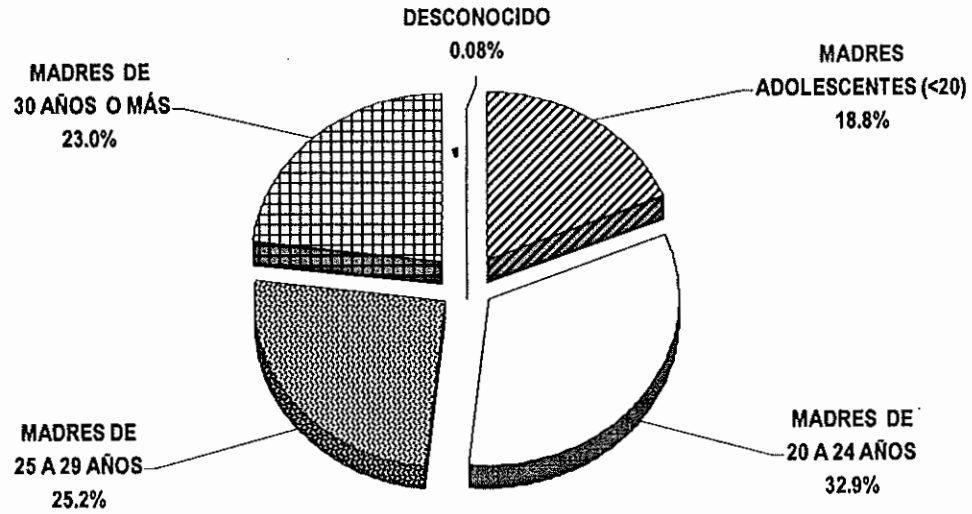

FUENTE: DEPARTAMENTO DE SALUD, SAPEESI, DIVISION DE ESTADISTICAS, SAN JUAN, PUERTO RICO
SOURCE: DEPARTMENT OF HEALTH, ASPESS, DIVISION OF STATISTICS, SAN JUAN, PUERTO RICO

Gráfica 3 - NACIMIENTOS VIVOS POR TIPO DE HOSPITAL
Chart 3 - LIVE BIRTH BY TYPE OF HOSPITAL
PUERTO RICO, 2001

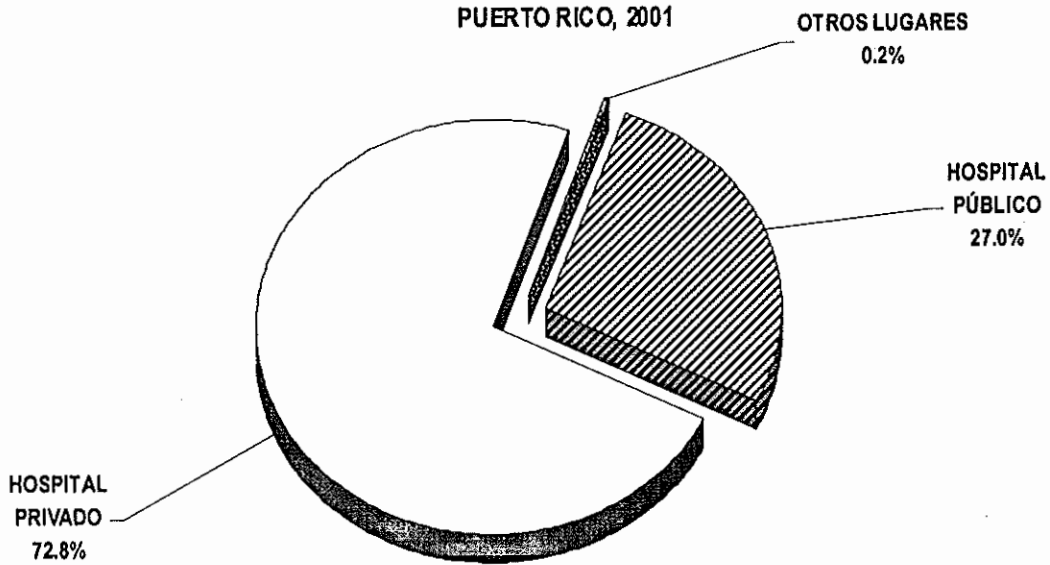

FUENTE: DEPARTAMENTO DE SALUD, SAPEESI, DIVISION DE ESTADISTICAS, SAN JUAN, PUERTO RICO
SOURCE: DEPARTMENT OF HEALTH, ASPESS, DIVISION OF STATISTICS, SAN JUAN, PUERTO RICO

Gráfica 4 - NACIMIENTOS VIVOS POR TRIMESTRE EN QUE COMENZÓ CUIDADO PRENATAL
Chart 4 - LIVE BIRTH BY TRIMESTER ON WHICH STARTED PRENATAL CARE
 PUERTO RICO, 2001

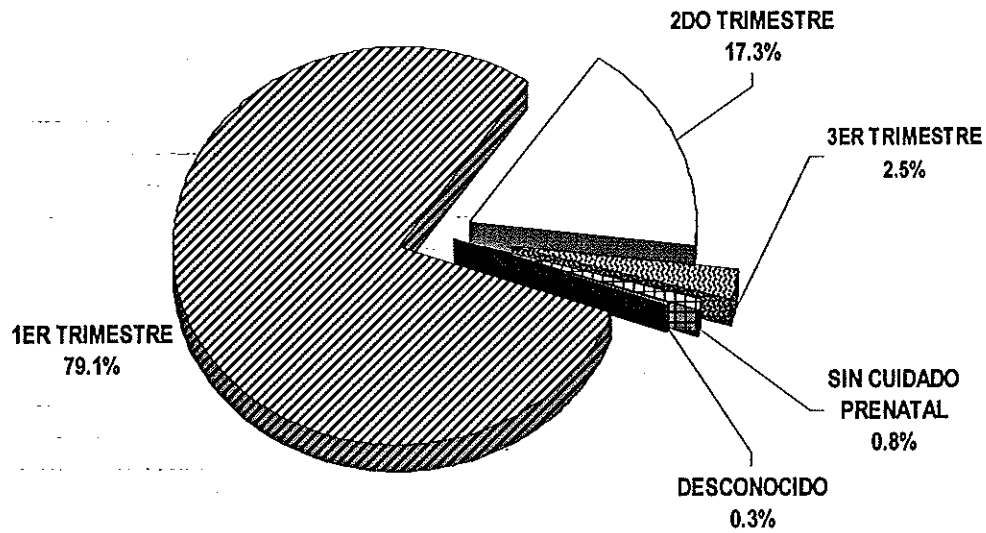

FUENTE: DEPARTAMENTO DE SALUD, SAPEESI, DIVISIÓN DE ESTADÍSTICAS, SAN JUAN, PUERTO RICO
 SOURCE: DEPARTMENT OF HEALTH, ASPEIS, DIVISION OF STATISTICS, SAN JUAN, PUERTO RICO

Gráfica 5 - NACIMIENTOS VIVOS POR ESCOLARIDAD DE LA MADRE
Chart 5 - LIVE BIRTH BY MOTHERS EDUCATION
 PUERTO RICO, 2001

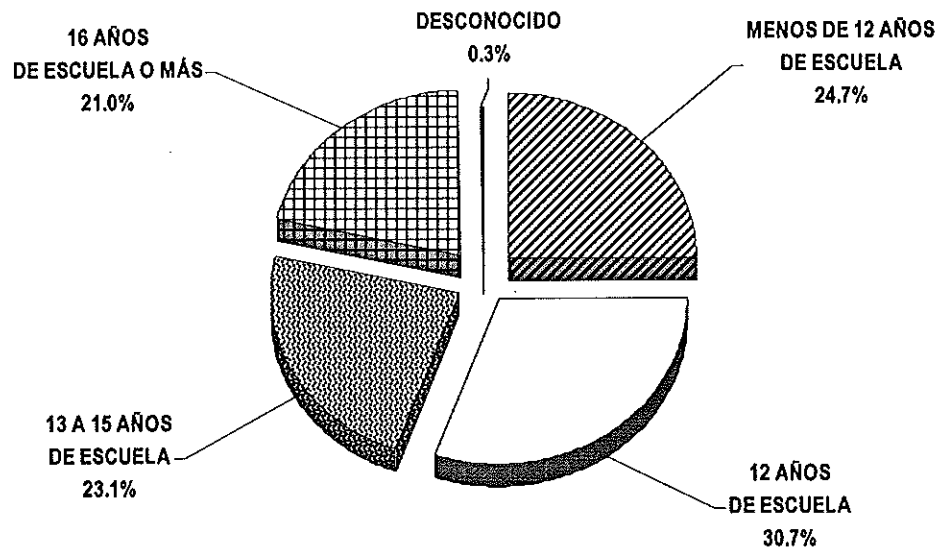

FUENTE: DEPARTAMENTO DE SALUD, SAPEESI, DIVISIÓN DE ESTADÍSTICAS, SAN JUAN, PUERTO RICO
 SOURCE: DEPARTMENT OF HEALTH, ASPEIS, DIVISION OF STATISTICS, SAN JUAN, PUERTO RICO

Tabla 4 - NACIMIENTOS VIVOS POR MUNICIPIO DE RESIDENCIA DE LA MADRE (BAJO PESO, ADOLESCENTES, SOLTERAS Y CUIDADO PRENATAL TEMPRANO)
 Table 4 - LIVE BIRTHS BY MUNICIPALITY OF MOTHER'S RESIDENCE (LOW BIRTH WEIGHT, TEENAGE MOTHERS, SINGLES AND EARLY PRENATAL CARE)
 PUERTO RICO, 2001

| REGIÓN Y/O MUNICIPIO RESIDENCIA | TOTAL NAC. | MUY BAJO PESO <1,500 GR O <3LB 5OZ | | BAJO PESO <2,500 GR O <5LB 9OZ | | MADRES ADOLESCENTES 10 A 19 AÑOS | | MADRES SOLTERAS Y/O CONSENSUAL | | CUIDADO PRENATAL PRIMER TRIMESTRE | |
|---------------------------------------|---------------|---------------------------------------|------------|-----------------------------------|--------------|-------------------------------------|---------------|-----------------------------------|---------------|--------------------------------------|---------------|
| | VIVOS | NÚMERO | POR CIENTO | NÚMERO | POR CIENTO | NÚMERO | POR CIENTO | NÚMERO | POR CIENTO | NÚMERO | POR CIENTO |
| | TOTAL | 55,983 | 744 | 1.3 | 6,280 | 11.2 | 10,549 | 18.8 | 28,606 | 51.1 | 44,275 |
| REGIÓN ARECIBO | 6,958 | 81 | 1.2 | 767 | 11.0 | 1,412 | 20.3 | 3,083 | 44.3 | 6,079 | 87.4 |
| ÁREA DE ARECIBO | 3,734 | 50 | 1.3 | 473 | 12.7 | 763 | 20.4 | 1,476 | 39.5 | 3,269 | 87.5 |
| ARECIBO | 1,371 | 20 | 1.5 | 173 | 12.6 | 276 | 20.1 | 593 | 43.3 | 1,204 | 87.8 |
| CAMUY | 479 | 6 | 1.3 | 56 | 11.7 | 87 | 18.2 | 143 | 29.9 | 445 | 92.9 |
| HATILLO | 528 | 3 | 0.6 | 55 | 10.4 | 107 | 20.3 | 176 | 33.3 | 456 | 86.4 |
| LARES | 466 | 7 | 1.5 | 71 | 15.2 | 121 | 26.0 | 196 | 42.1 | 410 | 88.0 |
| QUEBRADILLAS | 374 | 6 | 1.6 | 55 | 14.7 | 58 | 15.5 | 136 | 36.4 | 320 | 85.6 |
| UTUADO | 516 | 8 | 1.6 | 63 | 12.2 | 114 | 22.1 | 232 | 45.0 | 434 | 84.1 |
| ÁREA DE MANATÍ | 3,224 | 31 | 1.0 | 294 | 9.1 | 649 | 20.1 | 1,607 | 49.8 | 2,810 | 87.2 |
| BARCELONETA | 381 | 3 | 0.8 | 29 | 7.6 | 84 | 22.0 | 181 | 47.5 | 329 | 86.4 |
| CIALES | 296 | 1 | 0.3 | 33 | 11.1 | 63 | 21.3 | 156 | 52.7 | 261 | 88.2 |
| FLORIDA | 195 | 3 | 1.5 | 21 | 10.8 | 42 | 21.5 | 76 | 39.0 | 169 | 86.7 |
| MANATÍ | 734 | 8 | 1.1 | 55 | 7.5 | 130 | 17.7 | 369 | 50.3 | 629 | 85.7 |
| MOROVIS | 539 | 5 | 0.9 | 63 | 11.7 | 120 | 22.3 | 291 | 54.0 | 514 | 95.4 |
| VEGA BAJA | 1,079 | 11 | 1.0 | 93 | 8.6 | 210 | 19.5 | 534 | 49.5 | 908 | 84.2 |
| REGIÓN BAYAMÓN | 9,371 | 127 | 1.4 | 1,006 | 10.7 | 1,711 | 18.3 | 5,036 | 53.7 | 7,342 | 78.3 |
| ÁREA BARRANQUITAS | 2,127 | 26 | 1.2 | 234 | 11.0 | 485 | 22.8 | 1,279 | 60.1 | 1,788 | 84.1 |
| BARRANQUITAS | 450 | 4 | 0.9 | 52 | 11.6 | 113 | 25.1 | 290 | 64.4 | 369 | 82.0 |
| COMERÍO | 288 | 7 | 2.4 | 40 | 13.9 | 73 | 25.3 | 186 | 64.6 | 225 | 78.1 |
| COROZAL | 572 | 6 | 1.0 | 57 | 10.0 | 119 | 20.8 | 314 | 54.9 | 510 | 89.2 |
| NARANJITO | 434 | 4 | 0.9 | 49 | 11.3 | 94 | 21.7 | 249 | 57.4 | 371 | 85.5 |
| OROCOVIS | 383 | 5 | 1.3 | 36 | 9.4 | 86 | 22.5 | 240 | 62.7 | 313 | 81.7 |
| ÁREA DE BAYAMÓN | 4,783 | 64 | 1.3 | 512 | 10.7 | 744 | 15.6 | 2,345 | 49.0 | 3,745 | 78.3 |
| BAYAMÓN | 3,252 | 44 | 1.4 | 346 | 10.6 | 481 | 14.8 | 1,659 | 51.0 | 2,559 | 78.7 |
| TOA ALTA | 936 | 11 | 1.2 | 104 | 11.1 | 139 | 14.9 | 375 | 40.1 | 770 | 82.3 |
| VEGA ALTA | 595 | 9 | 1.5 | 62 | 10.4 | 124 | 20.8 | 311 | 52.3 | 416 | 69.9 |
| ÁREA DE CATAÑO | 2,461 | 37 | 1.5 | 260 | 10.6 | 482 | 19.6 | 1,412 | 57.4 | 1,809 | 73.5 |
| CATAÑO | 504 | 8 | 1.6 | 62 | 12.3 | 127 | 25.2 | 359 | 71.2 | 346 | 68.7 |
| DORADO | 546 | 10 | 1.8 | 52 | 9.5 | 95 | 17.4 | 277 | 50.7 | 387 | 70.9 |
| TOA BAJA | 1,411 | 19 | 1.3 | 146 | 10.3 | 260 | 18.4 | 776 | 55.0 | 1,076 | 76.3 |
| REGIÓN CAGUAS | 8,455 | 124 | 1.5 | 972 | 11.5 | 1,647 | 19.5 | 4,439 | 52.5 | 6,735 | 79.7 |
| ÁREA DE CAGUAS | 4,193 | 67 | 1.6 | 517 | 12.3 | 806 | 19.2 | 2,142 | 51.1 | 3,355 | 80.0 |
| AGUAS BUENAS | 428 | 6 | 1.4 | 56 | 13.1 | 95 | 22.2 | 220 | 51.4 | 354 | 82.7 |
| CAGUAS | 2,128 | 44 | 2.1 | 267 | 12.5 | 378 | 17.8 | 1,119 | 52.6 | 1,757 | 82.6 |
| GURABO | 536 | 5 | 0.9 | 63 | 11.8 | 81 | 15.1 | 229 | 42.7 | 398 | 74.3 |
| JUNCOS | 582 | 6 | 1.0 | 65 | 11.2 | 123 | 21.1 | 285 | 49.0 | 427 | 73.4 |
| SAN LORENZO | 519 | 6 | 1.2 | 66 | 12.7 | | | 289 | 55.7 | 419 | 80.7 |

Tabla 4 - NACIMIENTOS VIVOS POR MUNICIPIO DE RESIDENCIA DE LA MADRE (BAJO PESO, ADOLESCENTES, SOLTERAS Y CUIDADO PRENATAL TEMPRANO)

Table 4 - LIVE BIRTHS BY MUNICIPALITY OF MOTHER'S RESIDENCE (LOW BIRTH WEIGHT, TEENAGE MOTHERS, SINGLES AND EARLY PRENATAL CARE)

PUERTO RICO, 2001

Pag 2 de 3

| REGIÓN Y/O MUNICIPIO RESIDENCIA | TOTAL NAC. VIVOS | MUY BAJO PESO <1,500 GR O <3LB 5OZ | | BAJO PESO <2,500 GR O <5LB 9OZ | | MADRES ADOLESCENTES 10 A 19 AÑOS | | MADRES SOLTERAS Y/O CONSENSUAL | | CUIDADO PRENATAL PRIMER TRIMESTRE | |
|---------------------------------------|------------------------|---------------------------------------|------------|-----------------------------------|------------|-------------------------------------|------------|-----------------------------------|------------|--------------------------------------|------------|
| | | NÚMERO | POR CIENTO | NÚMERO | POR CIENTO | NÚMERO | POR CIENTO | NÚMERO | POR CIENTO | NÚMERO | POR CIENTO |
| ÁREA DE CAYEY | 1,794 | 23 | 1.3 | 201 | 11.2 | 352 | 19.6 | 1,022 | 57.0 | 1,356 | 75.6 |
| AIBONITO | 448 | 4 | 0.9 | 49 | 10.9 | 91 | 20.3 | 275 | 61.4 | 379 | 84.6 |
| CAYEY | 730 | 11 | 1.5 | 83 | 11.4 | 140 | 19.2 | 425 | 58.2 | 520 | 71.2 |
| CIDRA | 616 | 8 | 1.3 | 69 | 11.2 | 121 | 19.6 | 322 | 52.3 | 457 | 74.2 |
| ÁREA DE HUMACAO | 2,468 | 34 | 1.4 | 254 | 10.3 | 489 | 19.8 | 1,275 | 51.7 | 2,024 | 82.0 |
| HUMACAO | 875 | 9 | 1.0 | 99 | 11.3 | 168 | 19.2 | 447 | 51.1 | 692 | 79.1 |
| LAS PIEDRAS | 506 | 5 | 1.0 | 47 | 9.3 | 103 | 20.4 | 221 | 43.7 | 440 | 87.0 |
| MAUNABO | 176 | 5 | 2.8 | 19 | 10.8 | 36 | 20.5 | 107 | 60.8 | 140 | 79.5 |
| NAGUABO | 356 | 6 | 1.7 | 40 | 11.2 | 74 | 20.8 | 183 | 51.4 | 295 | 82.9 |
| YABUCOA | 555 | 9 | 1.6 | 49 | 8.8 | 108 | 19.5 | 317 | 57.1 | 457 | 82.3 |
| REGIÓN MAYAGÜEZ | 3,963 | 59 | 1.5 | 534 | 13.5 | 667 | 16.8 | 1,695 | 42.8 | 3,291 | 83.0 |
| ÁREA DE MAYAGUEZ | 2,830 | 41 | 1.4 | 376 | 13.3 | 488 | 17.2 | 1,198 | 42.3 | 2,306 | 81.5 |
| ANASCO | 390 | 2 | 0.5 | 41 | 10.5 | 57 | 14.6 | 144 | 36.9 | 321 | 82.3 |
| CABO ROJO | 595 | 9 | 1.5 | 89 | 15.0 | 88 | 14.8 | 230 | 38.7 | 490 | 82.4 |
| HORMIGUEROS | 206 | 3 | 1.5 | 26 | 12.6 | 23 | 11.2 | 77 | 37.4 | 173 | 84.0 |
| LAS MARIAS | 140 | 1 | 0.7 | 21 | 15.0 | 40 | 28.6 | 67 | 47.9 | 100 | 71.4 |
| MARICAO | 81 | 1 | 1.2 | 12 | 14.8 | 25 | 30.9 | 47 | 58.0 | 53 | 65.4 |
| MAYAGUEZ | 1,200 | 21 | 1.8 | 167 | 13.9 | 217 | 18.1 | 541 | 45.1 | 974 | 81.2 |
| RINCÓN | 218 | 4 | 1.8 | 20 | 9.2 | 38 | 17.4 | 92 | 42.2 | 195 | 89.4 |
| ÁREA DE SAN GERMÁN | 1,133 | 18 | 1.6 | 158 | 13.9 | 179 | 15.8 | 497 | 43.9 | 985 | 86.9 |
| LAJAS | 323 | 3 | 0.9 | 44 | 13.6 | 52 | 16.1 | 134 | 41.5 | 286 | 88.5 |
| SABANA GRANDE | 346 | 4 | 1.2 | 43 | 12.4 | 56 | 16.2 | 150 | 43.4 | 292 | 84.4 |
| SAN GERMÁN | 464 | 11 | 2.4 | 71 | 15.3 | 71 | 15.3 | 213 | 45.9 | 407 | 87.7 |
| SUBREGIÓN AGUADILLA | 3,147 | 36 | 1.1 | 312 | 9.9 | 543 | 17.3 | 1,063 | 33.8 | 2,752 | 87.4 |
| AGUADA | 585 | 3 | 0.5 | 48 | 8.2 | 83 | 14.2 | 186 | 31.8 | 525 | 89.7 |
| AGUADILLA | 769 | 6 | 0.8 | 67 | 8.7 | 148 | 19.2 | 300 | 39.0 | 658 | 85.6 |
| ISABELA | 601 | 7 | 1.2 | 60 | 10.0 | 96 | 16.0 | 210 | 34.9 | 500 | 83.2 |
| MOCA | 605 | 9 | 1.5 | 64 | 10.6 | 109 | 18.0 | 164 | 27.1 | 561 | 92.7 |
| SAN SEBASTIÁN | 587 | 11 | 1.9 | 73 | 12.4 | 107 | 18.2 | 203 | 34.6 | 508 | 86.5 |
| REGIÓN PONCE | 9,228 | 97 | 1.1 | 956 | 10.4 | 1,954 | 21.2 | 5,153 | 55.8 | 7,168 | 77.7 |
| ÁREA DE GUAYAMA | 1,771 | 13 | 0.7 | 157 | 8.9 | 432 | 24.4 | 1,075 | 60.7 | 1,464 | 82.7 |
| ARROYO | 287 | 3 | 1.0 | 31 | 10.8 | 81 | 28.2 | 176 | 61.3 | 242 | 84.3 |
| GUAYAMA | 740 | 5 | 0.7 | 49 | 6.6 | 172 | 23.2 | 447 | 60.4 | 601 | 81.2 |
| PATILLAS | 269 | 1 | 0.4 | 22 | 8.2 | 59 | 21.9 | 152 | 56.5 | 238 | 88.5 |
| SALINAS | 475 | 4 | 0.8 | 55 | 11.6 | 120 | 25.3 | 300 | 63.2 | 383 | 80.6 |
| ÁREA DE PONCE | 5,707 | 66 | 1.2 | 602 | 10.5 | 1,166 | 20.4 | 3,175 | 55.6 | 4,462 | 78.2 |
| ADJUNTAS | 320 | 5 | 1.6 | 40 | 12.5 | 70 | 21.9 | 154 | 48.1 | 271 | 84.7 |

Tabla 4 - NACIMIENTOS VIVOS POR MUNICIPIO DE RESIDENCIA DE LA MADRE (BAJO PESO, ADOLESCENTES, SOLTERAS Y CUIDADO PRENATAL TEMPRANO)
 Table 4 - LIVE BIRTHS BY MUNICIPALITY OF MOTHER'S RESIDENCE (LOW BIRTH WEIGHT, TEENAGE MOTHERS, SINGLES AND EARLY PRENATAL CARE)
 PUERTO RICO, 2001

Pag 3 de 3

| REGIÓN Y/O MUNICIPIO RESIDENCIA | TOTAL NAC. | MUY BAJO PESO <1,500 GR O <3LB 5OZ | | BAJO PESO <2,500 GR O <5LB 9OZ | | MADRES ADOLESCENTES 10 A 19 AÑOS | | MADRES SOLTERAS Y/O CONSENSUAL | | CUIDADO PRENATAL PRIMER TRIMESTRE | |
|---------------------------------|------------|------------------------------------|------------|--------------------------------|------------|----------------------------------|------------|--------------------------------|------------|-----------------------------------|------------|
| | VIVOS | NÚMERO | POR CIENTO | NÚMERO | POR CIENTO | NÚMERO | POR CIENTO | NÚMERO | POR CIENTO | NÚMERO | POR CIENTO |
| COAMO | 565 | 8 | 1.4 | 58 | 10.3 | 120 | 21.2 | 319 | 56.5 | 483 | 85.5 |
| JAYUYA | 273 | 1 | 0.4 | 29 | 10.6 | 76 | 27.8 | 137 | 50.2 | 211 | 77.3 |
| JUANA DIAZ | 833 | 8 | 1.0 | 90 | 10.8 | 159 | 19.1 | 453 | 54.4 | 700 | 84.0 |
| PONCE | 2,841 | 33 | 1.2 | 297 | 10.5 | 544 | 19.1 | 1,606 | 56.5 | 2,101 | 74.0 |
| SANTA ISABEL | 409 | 7 | 1.7 | 49 | 12.0 | 89 | 21.8 | 254 | 62.1 | 319 | 78.0 |
| VILLALBA | 466 | 4 | 0.9 | 39 | 8.4 | 108 | 23.2 | 252 | 54.1 | 377 | 80.9 |
| ÁREA DE YAUCO | 1,750 | 18 | 1.0 | 197 | 11.3 | 356 | 20.3 | 903 | 51.6 | 1,242 | 71.0 |
| GUÁNICA | 281 | 5 | 1.8 | 35 | 12.5 | 62 | 22.1 | 145 | 51.6 | 207 | 73.7 |
| GUAYANILLA | 365 | 1 | 0.3 | 38 | 10.4 | 80 | 21.9 | 212 | 58.1 | 250 | 68.5 |
| PENUELAS | 469 | 5 | 1.1 | 51 | 10.9 | 104 | 22.2 | 247 | 52.7 | 331 | 70.6 |
| YAUCO | 635 | 7 | 1.1 | 73 | 11.5 | 110 | 17.3 | 299 | 47.1 | 454 | 71.5 |
| REGIÓN METROPOLITANA | 12,575 | 181 | 1.4 | 1,463 | 11.6 | 2,186 | 17.4 | 7,018 | 55.8 | 9,417 | 74.9 |
| ÁREA DE CAROLINA | 4,969 | 88 | 1.8 | 625 | 12.6 | 878 | 17.7 | 2,553 | 51.4 | 3,612 | 72.7 |
| CANÓVANAS | 749 | 12 | 1.6 | 70 | 9.3 | 165 | 22.0 | 397 | 53.0 | 534 | 71.3 |
| CAROLINA | 2,745 | 47 | 1.7 | 344 | 12.5 | 419 | 15.3 | 1,423 | 51.8 | 1,942 | 70.7 |
| LOIZA | 430 | 11 | 2.6 | 86 | 20.0 | 128 | 29.8 | 296 | 68.8 | 323 | 75.1 |
| TRUJILLO ALTO | 1,045 | 18 | 1.7 | 125 | 12.0 | 166 | 15.9 | 437 | 41.8 | 813 | 77.8 |
| ÁREA DE SAN JUAN | 7,606 | 93 | 1.2 | 838 | 11.0 | 1,308 | 17.2 | 4,465 | 58.7 | 5,805 | 76.3 |
| GUAYNABO | 1,389 | 15 | 1.1 | 135 | 9.7 | 205 | 14.8 | 620 | 44.6 | 1,144 | 82.4 |
| SAN JUAN | 6,217 | 78 | 1.3 | 703 | 11.3 | 1,103 | 17.7 | 3,845 | 61.8 | 4,661 | 75.0 |
| SUBREGIÓN FAJARDO | 2,167 | 35 | 1.6 | 255 | 11.8 | 424 | 19.6 | 1,042 | 48.1 | 1,419 | 65.5 |
| CEIBA | 272 | 8 | 2.9 | 34 | 12.5 | 39 | 14.3 | 99 | 36.4 | 224 | 82.4 |
| CULEBRA | 27 | 2 | 7.4 | 7 | 25.9 | 2 | 7.4 | 9 | 33.3 | 22 | 81.5 |
| FAJARDO | 595 | 5 | 0.8 | 64 | 10.8 | 123 | 20.7 | 285 | 47.9 | 409 | 68.7 |
| LUQUILLO | 331 | 4 | 1.2 | 43 | 13.0 | 69 | 20.8 | 179 | 54.1 | 188 | 56.8 |
| RÍO GRANDE | 813 | 14 | 1.7 | 93 | 11.4 | 137 | 16.9 | 379 | 46.6 | 491 | 60.4 |
| VIEQUES | 129 | 2 | 1.6 | 14 | 10.9 | 54 | 41.9 | 91 | 70.5 | 85 | 65.9 |
| NO RESIDENTE | 99 | 2 | 2.0 | 12 | 12.1 | 4 | 4.0 | 57 | 57.6 | 58 | 58.6 |
| DESCONOCIDO | 20 | 2 | 10.0 | 3 | 15.0 | 1 | 5.0 | 20 | 100.0 | 14 | 70.0 |

FUENTE: DEPARTAMENTO DE SALUD, SAPEESI, DIVISION DE ESTADISTICAS, SAN JUAN, PUERTO RICO.

SOURCE: DEPARTMENT OF HEALTH, ASPESIS, DIVISION OF STATISTICS, SAN JUAN, PUERTO RICO.

Tabla 5 - PRIMERAS DIECINUEVE CAUSAS DE MUERTE
Table 5 - NINETEEN LEADING CAUSES OF DEATH
PUERTO RICO, 2001 Y 2000

| CAUSAS DE MUERTE 2/ | 2001 | | | | 2000 | | | |
|---|-------|---------------|------------|--------------|-------|---------------|------------|--------------|
| | Orden | Número | Por ciento | Tasa 1/ | Orden | Número | Por ciento | Tasa 1/ |
| TODAS LAS CAUSAS | --- | 28,794 | 100 | 749.9 | --- | 28,550 | 100 | 748.0 |
| ENFERMEDADES DEL CORAZÓN (I00-I099, I20-I519) | 1 | 5,181 | 18.0 | 134.9 | 1 | 5,222 | 18.3 | 136.8 |
| TUMORES MALIGNOS (C00 -C97) | 2 | 4,696 | 16.3 | 122.3 | 2 | 4,693 | 16.4 | 123.0 |
| DIABETES MELLITUS (E10 -E149) | 3 | 2,399 | 8.3 | 62.5 | 3 | 2,273 | 8.0 | 59.6 |
| ENFERMEDADES HIPERTENSIVAS (I10, I11 -139) | 4 | 1,679 | 5.8 | 43.7 | 4 | 1,575 | 5.5 | 41.3 |
| ENFERMEDADES CEREBROVASCULARES (I60 -I698) | 5 | 1,197 | 4.2 | 31.2 | 6 | 1,166 | 4.1 | 30.5 |
| TODOS LOS ACCIDENTES (V01 -X599, Y85 Y869) | 6 | 1,162 | 4.0 | 30.3 | 5 | 1,321 | 4.6 | 34.6 |
| ENFERMEDAD PULMONAR CRÓNICA (J40 -J47) | 7 | 1,147 | 4.0 | 29.9 | 7 | 1,144 | 4.0 | 30.0 |
| NEUMONÍA E INFLUENZA (J10 -J189) | 8 | 924 | 3.2 | 24.1 | 9 | 785 | 2.7 | 20.6 |
| ALZHEIMER (G30 -G309) | 9 | 881 | 3.1 | 22.9 | 11 | 709 | 2.5 | 18.6 |
| ENFERMEDADES DEL HÍGADO (K70 -K769) | 10 | 804 | 2.8 | 20.9 | 8 | 820 | 2.9 | 21.5 |
| NEFRITIS Y NEFROSIS (N00 N079, N17 -N19, N25 -N279) | 11 | 774 | 2.7 | 20.2 | 10 | 777 | 2.7 | 20.4 |
| HOMICIDIOS E INTERVENCIÓN LEGAL (X85 -Y099, Y871) | 12 | 752 | 2.6 | 19.6 | 12 | 698 | 2.4 | 18.3 |
| INFECCION VIRUS INMUNODEFICIENCIA HUMANA (B20 -B24) | 13 | 737 | 2.6 | 19.2 | 13 | 643 | 2.3 | 16.8 |
| SEPTICEMIA (A40 -A419) | 14 | 620 | 2.2 | 16.1 | 14 | 601 | 2.1 | 15.7 |
| COND. ORIGINADAS EN EL PERÍODO PERINATAL (P00-P969) | 15 | 336 | 1.2 | 8.8 | 15 | 375 | 1.3 | 9.8 |
| SUICIDIOS (X60 -X84, Y870) | 16 | 280 | 1.0 | 7.3 | 16 | 315 | 1.1 | 8.3 |
| ANOMALÍAS CONGÉNITAS (Q00 -Q999) | 17 | 141 | 0.5 | 3.7 | 17 | 163 | 0.6 | 4.3 |
| ATEROSCLEROSIS (I70 -I709) | 18 | 116 | 0.4 | 3.0 | 18 | 128 | 0.4 | 3.4 |
| SÍNDROME MUERTE SÚBITA INFANTIL (R95) | 19 | 2 | 0.0 | 0.1 | 19 | 4 | 0.0 | 0.1 |
| OTRAS CAUSAS | 20 | 4,966 | 17.2 | 129.3 | --- | 5,138 | 18.0 | 134.6 |

1/ TASA POR 100,000 HABITANTES.

2/ CODIFICACIÓN SEGÚN DÉCIMA CLASIFICACIÓN INTERNACIONAL DE ENFERMEDADES (ICD-10).

FUENTE: DEPARTAMENTO DE SALUD, SAPEESI, DIVISIÓN DE ESTADÍSTICAS, SAN JUAN, PUERTO RICO.

SOURCE: DEPARTMENT OF HEALTH, ASPESIS, DIVISION OF STATISTICS, SAN JUAN, PUERTO RICO.

Gráfica 6 - PRIMERAS DIECINUEVE CAUSAS DE MORTALIDAD*
Chart 6 - NINETEEN LEADING CAUSES OF DEATH
PUERTO RICO, 2001

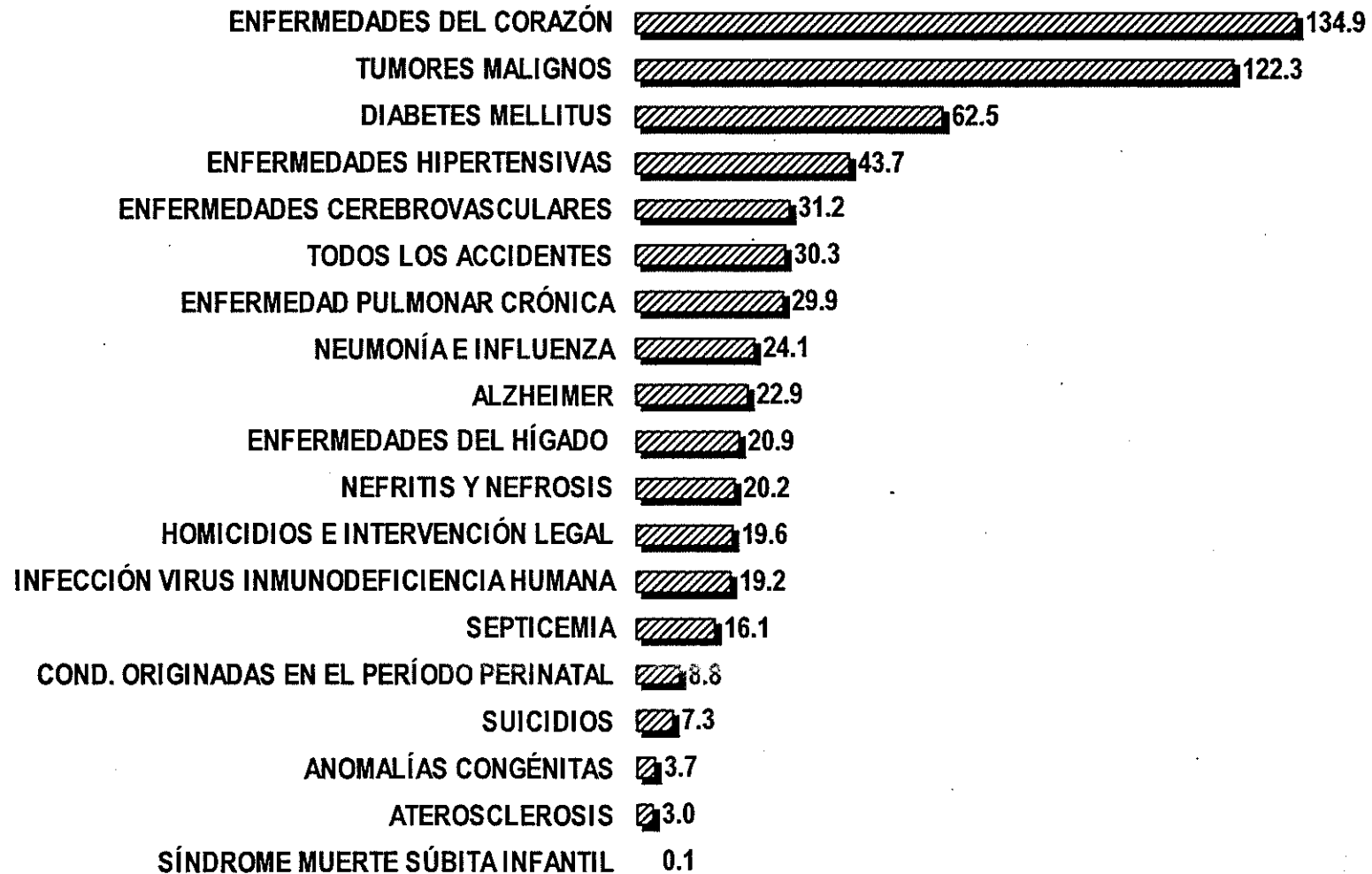

*TASAS POR 100,000 HABITANTES RATES PER 100,000 POPULATION
 FUENTE: DEPARTAMENTO DE SALUD, SAPEESI, DIVISIÓN DE ESTADÍSTICAS, SAN JUAN, PUERTO RICO
 SOURCE: DEPARTMENT OF HEALTH, ASPESIS, DIVISION OF STATISTICS, SAN JUAN, PUERTO RICO

Tabla 6 - TASAS* DE MORTALIDAD GENERAL POR REGIONES DE SALUD, MUNICIPIO DE RESIDENCIA Y CAUSAS ESPECÍFICAS
 Table 6 - GENERAL MORTALITY RATES BY REGIONS OF HEALTH, MUNICIPALITY OF RESIDENCE AND SELECTED CAUSES
 PUERTO RICO, 2001

Pag 1 de 6

| MUNICIPIOS MUNICIPALITIES | TOTAL | | ENF. CORAZÓN Heart Diseases | | CÁNCER | | DIABETES MELLITUS | | ACCIDENTES ACCIDENTS | | SIDA | | Cerebrovasculares Cerebrovasc. Dis. | |
|------------------------------|---------------|--------------|--------------------------------|--------------|--------------|--------------|-------------------|-------------|-------------------------|-------------|------------|-------------|--|-------------|
| | Núm. | Tasa | Núm. | Tasa | Núm. | Tasa | Núm. | Tasa | Núm. | Tasa | Núm. | Tasa | Núm. | Tasa |
| TOTAL | 28,794 | 749.9 | 5,181 | 134.9 | 4,696 | 122.3 | 2,399 | 62.5 | 1,162 | 30.3 | 737 | 19.2 | 1,197 | 31.2 |
| REGIÓN ARECIBO | 3,518 | 753.0 | 574 | 122.9 | 525 | 112.4 | 373 | 79.8 | 139 | 29.8 | 78 | 16.7 | 149 | 31.9 |
| ÁREA DE ARECIBO | 2,137 | 783.6 | 327 | 119.9 | 335 | 122.8 | 254 | 93.1 | 68 | 24.9 | 30 | 11.0 | 87 | 31.9 |
| ARECIBO | 856 | 848.9 | 129 | 127.9 | 130 | 128.9 | 105 | 104.1 | 22 | 21.8 | 15 | 14.9 | 35 | 34.7 |
| CAMUY | 273 | 759.2 | 44 | 122.4 | 40 | 111.2 | 35 | 97.3 | 13 | 36.2 | 5 | 13.9 | 4 | 11.1 |
| HATILLO | 297 | 749.7 | 47 | 118.6 | 59 | 148.9 | 37 | 93.4 | 11 | 27.8 | 5 | 12.6 | 13 | 32.8 |
| LARES | 252 | 719.7 | 39 | 111.4 | 35 | 100.0 | 23 | 65.7 | 8 | 22.8 | - | - | 19 | 54.3 |
| QUEBRADILLAS | 205 | 791.5 | 32 | 123.6 | 32 | 123.6 | 27 | 104.3 | 6 | 23.2 | 4 | 15.4 | 11 | 42.5 |
| UTUADO | 254 | 718.1 | 36 | 101.8 | 39 | 110.3 | 27 | 76.3 | 8 | 22.6 | 1 | 2.8 | 5 | 14.1 |
| ÁREA DE MANATÍ | 1,381 | 710.1 | 247 | 127.0 | 190 | 97.7 | 119 | 61.2 | 71 | 36.5 | 48 | 24.7 | 62 | 31.9 |
| BARCELONETA | 176 | 783.4 | 33 | 146.9 | 25 | 111.3 | 15 | 66.8 | 8 | 35.6 | 4 | 17.8 | 4 | 17.8 |
| CIALES | 155 | 775.2 | 22 | 110.0 | 27 | 135.0 | 9 | 45.0 | 9 | 45.0 | - | - | 9 | 45.0 |
| FLORIDA | 69 | 538.3 | 16 | 124.8 | 8 | 62.4 | 6 | 46.8 | 2 | 15.6 | 1 | 7.8 | 2 | 15.6 |
| MANATÍ | 344 | 745.3 | 57 | 123.5 | 47 | 101.8 | 37 | 80.2 | 17 | 36.8 | 14 | 30.3 | 21 | 45.5 |
| MOROVIS | 178 | 583.9 | 26 | 85.3 | 25 | 82.0 | 11 | 36.1 | 13 | 42.6 | 8 | 26.2 | 9 | 29.5 |
| VEGA BAJA | 459 | 733.6 | 93 | 148.6 | 58 | 92.7 | 41 | 65.5 | 22 | 35.2 | 21 | 33.6 | 17 | 27.2 |
| REGIÓN BAYAMÓN | 4,231 | 673.7 | 746 | 118.8 | 719 | 114.5 | 303 | 48.2 | 191 | 30.4 | 120 | 19.1 | 144 | 22.9 |
| ÁREA BARRANQUITAS | 873 | 621.2 | 155 | 110.3 | 135 | 96.1 | 62 | 44.1 | 45 | 32.0 | 13 | 9.3 | 38 | 27.0 |
| BARRANQUITAS | 170 | 580.9 | 31 | 105.9 | 22 | 75.2 | 13 | 44.4 | 15 | 51.3 | 6 | 20.5 | 10 | 34.2 |
| COMERÍO | 133 | 666.3 | 18 | 90.2 | 25 | 125.2 | 7 | 35.1 | 5 | 25.0 | 2 | 10.0 | 4 | 20.0 |
| COROZAL | 247 | 662.7 | 44 | 118.1 | 35 | 93.9 | 22 | 59.0 | 10 | 26.8 | 4 | 10.7 | 6 | 16.1 |
| NARANJITO | 188 | 628.8 | 35 | 117.1 | 29 | 97.0 | 14 | 46.8 | 10 | 33.4 | 1 | 3.3 | 7 | 23.4 |
| ORCOVIS | 135 | 559.4 | 27 | 111.9 | 24 | 99.4 | 6 | 24.9 | 5 | 20.7 | - | - | 11 | 45.6 |
| ÁREA DE BAYAMÓN | 2,287 | 695.0 | 401 | 121.9 | 422 | 128.2 | 170 | 51.7 | 89 | 27.0 | 59 | 17.9 | 72 | 21.9 |
| BAYAMÓN | 1,696 | 755.7 | 292 | 130.1 | 312 | 139.0 | 122 | 54.4 | 72 | 32.1 | 48 | 21.4 | 53 | 23.6 |
| TOA ALTA | 327 | 492.6 | 63 | 94.9 | 61 | 91.9 | 26 | 39.2 | 15 | 22.6 | 5 | 7.5 | 10 | 15.1 |
| VEGA ALTA | 264 | 689.9 | 46 | 120.2 | 49 | 128.0 | 22 | 57.5 | 2 | 5.2 | 6 | 15.7 | 9 | 23.5 |
| ÁREA DE CATAÑO | 1,071 | 676.2 | 190 | 120.0 | 162 | 102.3 | 71 | 44.8 | 57 | 36.0 | 48 | 30.3 | 34 | 21.5 |
| CATAÑO | 219 | 743.6 | 44 | 149.4 | 23 | 78.1 | 8 | 27.2 | 11 | 37.4 | 20 | 67.9 | 5 | 17.0 |
| DORADO | 249 | 724.6 | 45 | 130.9 | 44 | 128.0 | 26 | 75.7 | 12 | 34.9 | 7 | 20.4 | 12 | 34.9 |
| TOA BAJA | 603 | 637.6 | 101 | 106.8 | 95 | 100.5 | 37 | 39.1 | 34 | 36.0 | 21 | 22.2 | 17 | 18.0 |
| REGIÓN DE CAGUAS | 3,987 | 692.7 | 705 | 122.5 | 698 | 121.3 | 295 | 51.3 | 169 | 29.4 | 87 | 15.1 | 151 | 26.2 |
| ÁREA DE CAGUAS | 2,000 | 696.7 | 354 | 123.3 | 358 | 124.7 | 138 | 48.1 | 81 | 28.2 | 47 | 16.4 | 65 | 22.6 |
| AGUAS BUENAS | 200 | 679.7 | 39 | 132.5 | 35 | 118.9 | 18 | 61.2 | 7 | 23.8 | 2 | 6.8 | 4 | 13.6 |
| CAGUAS | 1,011 | 715.8 | 158 | 111.9 | 186 | 131.7 | 65 | 46.0 | 40 | 28.3 | 30 | 21.2 | 36 | 25.5 |
| GURABO | 243 | 645.0 | 56 | 148.7 | 42 | 111.5 | 17 | 45.1 | 12 | 31.9 | 10 | 26.5 | 8 | 21.2 |
| JUNCOS | 248 | 668.4 | 54 | 145.5 | 35 | 94.3 | 19 | 51.2 | 9 | 24.3 | 3 | 8.1 | 9 | 24.3 |
| SAN LORENZO | 298 | 715.6 | 47 | 112.9 | 60 | 144.1 | 19 | 45.6 | 13 | 31.2 | 2 | 4.8 | 8 | 19.2 |
| ÁREA DE CAYEY | 793 | 674.0 | 138 | 117.3 | 127 | 107.9 | 54 | 45.9 | 37 | 31.4 | 14 | 11.9 | 47 | 39.9 |
| AIBONITO | 199 | 746.7 | 40 | 150.1 | 29 | 108.8 | 19 | 71.3 | 7 | 26.3 | - | - | 16 | 60.0 |
| CAYEY | 342 | 720.7 | 58 | 122.2 | 58 | 122.2 | 21 | 44.3 | 18 | 37.9 | 11 | 23.2 | 18 | 37.9 |
| CIDRA | 252 | 578.6 | 40 | 91.8 | 40 | 91.8 | 14 | 32.1 | 12 | 27.6 | 3 | 6.9 | 13 | 29.8 |
| ÁREA DE HUMACAO | 1,194 | 698.8 | 213 | 124.7 | 213 | 124.7 | 103 | 60.3 | 51 | 29.8 | 26 | 15.2 | 39 | 22.8 |
| HUMACAO | 447 | 752.0 | 75 | 126.2 | 80 | 134.6 | 45 | 75.7 | 20 | 33.6 | 10 | 16.8 | 8 | 13.5 |
| LAS PIEDRAS | 208 | 590.3 | 30 | 85.1 | 40 | 113.5 | 15 | 42.6 | 7 | 19.9 | 4 | 11.4 | 8 | 22.7 |
| MAUNABO | 98 | 766.7 | 19 | 148.6 | 18 | 140.8 | 6 | 46.9 | 3 | 23.5 | 3 | 23.5 | 7 | 54.8 |
| NAGUABO | 173 | 724.8 | 34 | 142.4 | 28 | 117.3 | 11 | 46.1 | 8 | 33.5 | 8 | 33.5 | 5 | 20.9 |
| YABUCOA | 268 | 677.8 | 55 | 139.1 | 47 | 118.9 | 26 | 65.8 | 13 | 32.9 | 1 | 2.5 | 11 | 27.8 |

Tabla 6 - TASAS* DE MORTALIDAD GENERAL POR REGIONES DE SALUD, MUNICIPIO DE RESIDENCIA Y CAUSAS ESPECÍFICAS
 Table 6 - GENERAL MORTALITY RATES BY REGIONS OF HEALTH, MUNICIPALITY OF RESIDENCE AND SELECTED CAUSES
 PUERTO RICO, 2001

Pag 2 de 6

| MUNICIPIOS MUNICIPALITIES | TOTAL | | ENF. CORAZÓN Heart Diseases | | CÁNCER | | DIABETES MELLITUS | | ACCIDENTES ACCIDENTS | | SIDA | | Cerebrovasculares Cerebrovasc. Dis. | |
|------------------------------|-------|-------|--------------------------------|-------|--------|-------|-------------------|-------|-------------------------|------|------|------|--|------|
| | Núm. | Tasa | Núm. | Tasa | Núm. | Tasa | Núm. | Tasa | Núm. | Tasa | Núm. | Tasa | Núm. | Tasa |
| REGIÓN MAYAGÜEZ | 2,549 | 810.7 | 468 | 148.8 | 410 | 130.4 | 235 | 74.7 | 93 | 29.6 | 51 | 16.2 | 125 | 39.8 |
| ÁREA DE MAYAGÜEZ | 1,850 | 825.0 | 329 | 146.7 | 302 | 134.7 | 158 | 70.5 | 74 | 33.0 | 43 | 19.2 | 90 | 40.1 |
| AÑASCO | 207 | 721.6 | 34 | 118.5 | 27 | 94.1 | 21 | 73.2 | 6 | 20.9 | 5 | 17.4 | 7 | 24.4 |
| CABO ROJO | 402 | 840.0 | 68 | 142.1 | 71 | 148.4 | 34 | 71.0 | 19 | 39.7 | 2 | 4.2 | 16 | 33.4 |
| HORMIGUEROS | 127 | 757.6 | 19 | 113.3 | 26 | 155.1 | 11 | 65.6 | 8 | 47.7 | - | - | 12 | 71.6 |
| LAS MARIAS | 75 | 666.3 | 13 | 115.5 | 12 | 106.6 | 13 | 115.5 | 5 | 44.4 | 1 | 8.9 | 1 | 8.9 |
| MARICAO | 42 | 648.7 | 8 | 123.6 | 6 | 92.7 | 3 | 46.3 | 1 | 15.4 | - | - | 3 | 46.3 |
| MAYAGÜEZ | 878 | 894.6 | 165 | 168.1 | 143 | 145.7 | 69 | 70.3 | 31 | 31.6 | 32 | 32.6 | 46 | 46.9 |
| RINCÓN | 119 | 790.5 | 22 | 146.1 | 17 | 112.9 | 7 | 46.5 | 4 | 26.6 | 3 | 19.9 | 5 | 33.2 |
| ÁREA DE SAN GERMÁN | 699 | 775.1 | 139 | 154.1 | 108 | 119.8 | 77 | 85.4 | 19 | 21.1 | 8 | 8.9 | 35 | 38.8 |
| LAJAS | 188 | 707.2 | 34 | 127.9 | 30 | 112.8 | 19 | 71.5 | 6 | 22.6 | 1 | 3.8 | 8 | 30.1 |
| SABANA GRANDE | 217 | 826.0 | 52 | 197.9 | 32 | 121.8 | 21 | 79.9 | 5 | 19.0 | 2 | 7.6 | 14 | 53.3 |
| SAN GERMÁN | 294 | 787.6 | 53 | 142.0 | 46 | 123.2 | 37 | 99.1 | 8 | 21.4 | 5 | 13.4 | 13 | 34.8 |
| SUB REGIÓN AGUADILLA | 1,824 | 765.6 | 355 | 149.0 | 240 | 100.7 | 200 | 83.9 | 67 | 28.1 | 26 | 10.9 | 79 | 33.2 |
| AGUADA | 258 | 603.9 | 42 | 98.3 | 39 | 91.3 | 26 | 60.9 | 14 | 32.8 | 2 | 4.7 | 5 | 11.7 |
| AGUADILLA | 541 | 829.1 | 103 | 157.8 | 67 | 102.7 | 64 | 98.1 | 21 | 32.2 | 15 | 23.0 | 23 | 35.2 |
| ISABELA | 392 | 870.7 | 70 | 155.5 | 56 | 124.4 | 34 | 75.5 | 12 | 26.7 | 3 | 6.7 | 17 | 37.8 |
| MOCA | 253 | 625.3 | 47 | 116.2 | 32 | 79.1 | 32 | 79.1 | 7 | 17.3 | 1 | 2.5 | 14 | 34.6 |
| SAN SEBASTIÁN | 380 | 848.3 | 93 | 207.6 | 46 | 102.7 | 44 | 98.2 | 13 | 29.0 | 5 | 11.2 | 20 | 44.6 |
| REGIÓN PONCE | 4,575 | 766.3 | 959 | 160.6 | 757 | 126.8 | 424 | 71.0 | 163 | 27.3 | 114 | 19.1 | 224 | 37.5 |
| ÁREA DE GUAYAMA | 894 | 775.1 | 164 | 142.2 | 163 | 141.3 | 72 | 62.4 | 44 | 38.1 | 31 | 26.9 | 55 | 47.7 |
| ARROYO | 149 | 778.6 | 26 | 135.9 | 24 | 125.4 | 15 | 78.4 | 6 | 31.4 | 3 | 15.7 | 9 | 47.0 |
| GUAYAMA | 356 | 798.5 | 64 | 143.5 | 70 | 157.0 | 27 | 60.6 | 14 | 31.4 | 14 | 31.4 | 23 | 51.6 |
| PATILLAS | 174 | 861.2 | 28 | 138.6 | 27 | 133.6 | 18 | 89.1 | 10 | 49.5 | 5 | 24.7 | 9 | 44.5 |
| SALINAS | 215 | 684.5 | 46 | 146.5 | 42 | 133.7 | 12 | 38.2 | 14 | 44.6 | 9 | 28.7 | 14 | 44.6 |
| ÁREA DE PONCE | 2,785 | 768.7 | 601 | 165.9 | 461 | 127.2 | 255 | 70.4 | 89 | 24.6 | 75 | 20.7 | 120 | 33.1 |
| ADJUNTAS | 147 | 769.7 | 32 | 167.6 | 33 | 172.8 | 12 | 62.8 | 2 | 10.5 | - | - | 6 | 31.4 |
| COAMO | 302 | 794.7 | 63 | 165.8 | 52 | 136.8 | 23 | 60.5 | 8 | 21.1 | 4 | 10.5 | 12 | 31.6 |
| JAYUYA | 118 | 673.9 | 29 | 165.6 | 22 | 125.6 | 9 | 51.4 | 5 | 28.6 | 1 | 5.7 | 5 | 28.6 |
| JUANA DÍAZ | 372 | 727.9 | 77 | 150.7 | 61 | 119.4 | 36 | 70.4 | 17 | 33.3 | 8 | 15.7 | 18 | 35.2 |
| PONCE | 1,507 | 809.0 | 327 | 175.5 | 244 | 131.0 | 145 | 77.8 | 45 | 24.2 | 53 | 28.5 | 71 | 38.1 |
| SANTA ISABEL | 189 | 862.3 | 33 | 150.6 | 30 | 136.9 | 17 | 77.6 | 8 | 36.5 | 9 | 41.1 | 6 | 27.4 |
| VILLALBA | 150 | 528.2 | 40 | 140.9 | 19 | 66.9 | 13 | 45.8 | 4 | 14.1 | - | - | 2 | 7.0 |
| ÁREA DE YAUCO | 896 | 750.7 | 194 | 162.5 | 133 | 111.4 | 97 | 81.3 | 30 | 25.1 | 8 | 6.7 | 49 | 41.1 |
| GUÁNICA | 189 | 855.6 | 35 | 158.4 | 25 | 113.2 | 29 | 131.3 | 8 | 36.2 | 2 | 9.1 | 13 | 58.8 |
| GUAYANILLA | 178 | 766.3 | 47 | 202.3 | 18 | 77.5 | 15 | 64.6 | 6 | 25.8 | 2 | 8.6 | 11 | 47.4 |
| PEÑUELAS | 177 | 651.1 | 40 | 147.1 | 30 | 110.4 | 16 | 58.9 | 3 | 11.0 | 2 | 7.4 | 5 | 18.4 |
| YAUCO | 352 | 751.4 | 72 | 153.7 | 60 | 128.1 | 37 | 79.0 | 13 | 27.7 | 2 | 4.3 | 20 | 42.7 |
| REGIÓN METROPOLITANA | 6,843 | 781.2 | 1,149 | 131.2 | 1,145 | 130.7 | 485 | 55.4 | 267 | 30.5 | 229 | 26.1 | 281 | 32.1 |
| ÁREA DE CAROLINA | 2,279 | 667.8 | 365 | 107.0 | 397 | 116.3 | 156 | 45.7 | 98 | 28.7 | 61 | 17.9 | 81 | 23.7 |
| CANÓVANAS | 302 | 685.5 | 60 | 136.2 | 46 | 104.4 | 22 | 49.9 | 14 | 31.8 | 13 | 29.5 | 11 | 25.0 |
| CAROLINA | 1,348 | 721.1 | 216 | 115.5 | 238 | 127.3 | 97 | 51.9 | 51 | 27.3 | 34 | 18.2 | 44 | 23.5 |
| LOIZA | 177 | 538.3 | 24 | 73.0 | 26 | 79.1 | 11 | 33.5 | 6 | 18.2 | 7 | 21.3 | 8 | 24.3 |
| TRUJILLO ALTO | 452 | 584.0 | 65 | 84.0 | 87 | 112.4 | 26 | 33.6 | 27 | 34.9 | 7 | 9.0 | 18 | 23.3 |
| ÁREA DE SAN JUAN | 4,564 | 853.6 | 784 | 146.6 | 748 | 139.9 | 329 | 61.5 | 169 | 31.6 | 168 | 31.4 | 200 | 37.4 |
| GUAYNABO | 676 | 670.6 | 127 | 126.0 | 118 | 117.1 | 47 | 46.6 | 27 | 26.8 | 15 | 14.9 | 33 | 32.7 |
| SAN JUAN | 3,888 | 896.1 | 657 | 151.4 | 630 | 145.2 | 282 | 65.0 | 142 | 32.7 | 153 | 35.3 | 167 | 38.5 |
| SUB REGIÓN FAJARDO | 1,080 | 753.3 | 181 | 126.2 | 179 | 124.8 | 75 | 52.3 | 44 | 30.7 | 27 | 18.8 | 34 | 23.7 |
| CEIBA | 111 | 613.5 | 22 | 121.6 | 18 | 99.5 | 12 | 66.3 | 5 | 27.6 | 1 | 5.5 | 2 | 11.1 |
| CULEBRA | 11 | 577.4 | 3 | 157.5 | 1 | 52.5 | 1 | 52.5 | - | - | - | - | 1 | 52.5 |

Tabla 6 - TASAS* DE MORTALIDAD GENERAL POR REGIONES DE SALUD, MUNICIPIO DE RESIDENCIA Y CAUSAS ESPECÍFICAS
 Table 6 - GENERAL MORTALITY RATES BY REGIONS OF HEALTH, MUNICIPALITY OF RESIDENCE AND SELECTED CAUSES
 PUERTO RICO, 2001

Pag 3 de 6

| MUNICIPIOS MUNICIPALITIES | TOTAL | | ENF. CORAZÓN Heart Diseases | | CÁNCER | | DIABETES MELLITUS | | ACCIDENTES ACCIDENTS | | SIDA | | Cerebrovasculares Cerebrovasc. Dls. | |
|------------------------------|-------|--------|--------------------------------|-------|--------|-------|-------------------|------|-------------------------|------|------|------|--|------|
| | Núm. | Tasa | Núm. | Tasa | Núm. | Tasa | Núm. | Tasa | Núm. | Tasa | Núm. | Tasa | Núm. | Tasa |
| FAJARDO | 352 | 856.0 | 62 | 150.8 | 63 | 153.2 | 23 | 55.9 | 8 | 19.5 | 5 | 12.2 | 12 | 29.2 |
| LUQUILLO | 158 | 790.0 | 22 | 110.0 | 20 | 100.0 | 11 | 55.0 | 8 | 40.0 | 7 | 35.0 | 3 | 15.0 |
| RÍO GRANDE | 356 | 670.5 | 52 | 97.9 | 59 | 111.1 | 22 | 41.4 | 19 | 35.8 | 9 | 17.0 | 13 | 24.5 |
| VIEQUES | 92 | 1004.5 | 20 | 218.4 | 18 | 196.5 | 6 | 65.5 | 4 | 43.7 | 5 | 54.6 | 3 | 32.8 |
| P R NO ESPECIFICADO | - | - | - | - | - | - | - | - | - | - | - | - | - | - |
| NO RESIDENTE | 156 | - | 30 | - | 21 | - | 8 | - | 28 | - | 2 | - | 10 | - |
| CANADA | 5 | - | - | - | - | - | - | - | 1 | - | - | - | - | - |
| CUBA | 1 | - | - | - | - | - | - | - | - | - | - | - | - | - |
| ESTADOS UNIDOS | 86 | - | 23 | - | 8 | - | 7 | - | 13 | - | 2 | - | 5 | - |
| GUAM | - | - | - | - | - | - | - | - | - | - | - | - | - | - |
| ISLAS VÍRGENES | 37 | - | 6 | - | 9 | - | - | - | 5 | - | - | - | 3 | - |
| MEJICO | 2 | - | 1 | - | - | - | - | - | 1 | - | - | - | - | - |
| REPÚBLICA DOMINICANA | 6 | - | - | - | - | - | - | - | 1 | - | - | - | 1 | - |
| OTROS PAISES | 19 | - | - | - | 4 | - | 1 | - | 7 | - | - | - | 1 | - |
| DESCONOCIDOS | 31 | - | 14 | - | 2 | - | 1 | - | 1 | - | 3 | - | - | - |



Tabla 6 - TASAS* DE MORTALIDAD GENERAL POR REGIONES DE SALUD, MUNICIPIO DE RESIDENCIA Y CAUSAS ESPECÍFICAS
 Table 6 - GENERAL MORTALITY RATES BY REGIONS OF HEALTH, MUNICIPALITY OF RESIDENCE AND SELECTED CAUSES
 PUERTO RICO, 2001

Pag 4 de 6

| MUNICIPIOS MUNICIPALITIES | ENF. PULMONAR OBST. - COPD | | NEUMONÍA E INFLUENZA | | HIPERTENSIVAS HIPERTENSIVE | | HOMICIDIOS HOMICIDES | | ENF. HIGADO LIVER DISEAS | | SEPTICEMIA SEPTICAEMIA | | OTRAS CAUSAS OTHER CAUSES | |
|------------------------------|-------------------------------|-------------|-------------------------|-------------|-------------------------------|-------------|-------------------------|-------------|-----------------------------|-------------|---------------------------|-------------|------------------------------|--------------|
| | Núm. | Tasa | Núm. | Tasa | Núm. | Tasa | Núm. | Tasa | Núm. | Tasa | Núm. | Tasa | Núm. | Tasa |
| TOTAL | 1,147 | 29.9 | 924 | 24.1 | 1,679 | 43.7 | 752 | 19.6 | 804 | 20.9 | 620 | 16.1 | 7,496 | 195.2 |
| REGIÓN ARECIBO | 233 | 49.9 | 108 | 23.1 | 197 | 42.2 | 30 | 6.4 | 84 | 18.0 | 75 | 16.1 | 953 | 204.0 |
| ÁREA DE ARECIBO | 142 | 52.1 | 63 | 23.1 | 123 | 45.1 | 16 | 5.9 | 54 | 19.8 | 36 | 13.2 | 602 | 220.8 |
| ARECIBO | 55 | 54.5 | 28 | 27.8 | 44 | 43.6 | 6 | 5.9 | 20 | 19.8 | 14 | 13.9 | 253 | 250.9 |
| CAMUY | 16 | 44.5 | 4 | 11.1 | 20 | 55.6 | 2 | 5.6 | 6 | 16.7 | 6 | 16.7 | 78 | 216.9 |
| HATILLO | 25 | 63.1 | 8 | 20.2 | 12 | 30.3 | 2 | 5.0 | 2 | 5.0 | 5 | 12.6 | 71 | 179.2 |
| LARES | 20 | 57.1 | 10 | 28.6 | 15 | 42.8 | 2 | 5.7 | 7 | 20.0 | 7 | 20.0 | 67 | 191.3 |
| QUEBRADILLAS | 7 | 27.0 | 7 | 27.0 | 11 | 42.5 | - | - | 8 | 30.9 | - | - | 60 | 231.7 |
| UTUADO | 19 | 53.7 | 6 | 17.0 | 21 | 59.4 | 4 | 11.3 | 11 | 31.1 | 4 | 11.3 | 73 | 206.4 |
| ÁREA DE MANATÍ | 91 | 46.8 | 45 | 23.1 | 74 | 38.0 | 14 | 7.2 | 30 | 15.4 | 39 | 20.1 | 351 | 180.5 |
| BARCELONETA | 13 | 57.9 | 8 | 35.6 | 7 | 31.2 | - | - | 4 | 17.8 | 4 | 17.8 | 51 | 227.0 |
| CIALES | 19 | 95.0 | 4 | 20.0 | 6 | 30.0 | 3 | 15.0 | 3 | 15.0 | 4 | 20.0 | 40 | 200.1 |
| FLORIDA | 8 | 62.4 | 1 | 7.8 | 3 | 23.4 | - | - | 2 | 15.6 | 1 | 7.8 | 19 | 148.2 |
| MANATÍ | 19 | 41.2 | 12 | 26.0 | 19 | 41.2 | - | - | 5 | 10.8 | 10 | 21.7 | 86 | 186.3 |
| MOROVIS | 13 | 42.6 | 7 | 23.0 | 9 | 29.5 | 3 | 9.8 | 2 | 6.6 | 2 | 6.6 | 50 | 164.0 |
| VEGA BAJA | 19 | 30.4 | 13 | 20.8 | 30 | 48.0 | 8 | 12.8 | 14 | 22.4 | 18 | 28.8 | 105 | 167.8 |
| REGIÓN BAYAMÓN | 189 | 30.1 | 130 | 20.7 | 271 | 43.2 | 114 | 18.2 | 115 | 18.3 | 85 | 13.5 | 1,104 | 175.8 |
| ÁREA BARRANQUITAS | 52 | 37.0 | 19 | 13.5 | 66 | 47.0 | 12 | 8.5 | 28 | 19.9 | 12 | 8.5 | 236 | 167.9 |
| BARRANQUITAS | 10 | 34.2 | - | - | 7 | 23.9 | 2 | 6.8 | 4 | 13.7 | - | - | 50 | 170.8 |
| COMERÍO | 11 | 55.1 | 4 | 20.0 | 6 | 30.1 | 2 | 10.0 | 9 | 45.1 | 3 | 15.0 | 37 | 185.4 |
| COROZAL | 12 | 32.2 | 7 | 18.8 | 31 | 83.2 | 3 | 8.0 | 9 | 24.1 | 4 | 10.7 | 60 | 161.0 |
| NARANJITO | 9 | 30.1 | 7 | 23.4 | 19 | 63.6 | 3 | 10.0 | 1 | 3.3 | 3 | 10.0 | 50 | 167.2 |
| OROCOVIS | 10 | 41.4 | 1 | 4.1 | 3 | 12.4 | 2 | 8.3 | 5 | 20.7 | 2 | 8.3 | 39 | 161.6 |
| ÁREA DE BAYAMÓN | 96 | 29.2 | 66 | 20.1 | 136 | 41.3 | 56 | 17.0 | 58 | 17.6 | 53 | 16.1 | 609 | 185.1 |
| BAYAMÓN | 63 | 28.1 | 46 | 20.5 | 97 | 43.2 | 47 | 20.9 | 45 | 20.1 | 42 | 18.7 | 457 | 203.6 |
| TOA ALTA | 14 | 21.1 | 11 | 16.6 | 27 | 40.7 | 6 | 9.0 | 7 | 10.5 | 3 | 4.5 | 79 | 119.0 |
| VEGA ALTA | 19 | 49.7 | 9 | 23.5 | 12 | 31.4 | 3 | 7.8 | 6 | 15.7 | 8 | 20.9 | 73 | 190.8 |
| ÁREA DE CATAÑO | 41 | 25.9 | 45 | 28.4 | 69 | 43.6 | 46 | 29.0 | 29 | 18.3 | 20 | 12.6 | 259 | 163.5 |
| CATAÑO | 10 | 34.0 | 13 | 44.1 | 12 | 40.7 | 16 | 54.3 | 9 | 30.6 | 2 | 6.8 | 46 | 156.2 |
| DORADO | 9 | 26.2 | 7 | 20.4 | 18 | 52.4 | 5 | 14.5 | 3 | 8.7 | 3 | 8.7 | 58 | 168.8 |
| TOA BAJA | 22 | 23.3 | 25 | 26.4 | 39 | 41.2 | 25 | 26.4 | 17 | 18.0 | 15 | 15.9 | 155 | 163.9 |
| REGIÓN DE CAGUAS | 170 | 29.5 | 127 | 22.1 | 239 | 41.5 | 93 | 16.2 | 137 | 23.8 | 112 | 19.5 | 1,004 | 174.4 |
| ÁREA DE CAGUAS | 77 | 26.8 | 67 | 23.3 | 127 | 44.2 | 56 | 19.5 | 81 | 28.2 | 59 | 20.6 | 490 | 170.7 |
| AGUAS BUENAS | 13 | 44.2 | 4 | 13.6 | 19 | 64.6 | 7 | 23.8 | 6 | 20.4 | 6 | 20.4 | 40 | 135.9 |
| CAGUAS | 32 | 22.7 | 40 | 28.3 | 66 | 46.7 | 26 | 18.4 | 46 | 32.6 | 30 | 21.2 | 256 | 181.3 |
| GURABO | 8 | 21.2 | 7 | 18.6 | 14 | 37.2 | 4 | 10.6 | 6 | 15.9 | 2 | 5.3 | 57 | 151.3 |
| JUNCOS | 13 | 35.0 | 12 | 32.3 | 13 | 35.0 | 8 | 21.6 | 11 | 29.6 | 10 | 27.0 | 52 | 140.1 |
| SAN LORENZO | 11 | 26.4 | 4 | 9.6 | 15 | 36.0 | 11 | 26.4 | 12 | 28.8 | 11 | 26.4 | 85 | 204.1 |
| ÁREA DE CAYEY | 45 | 38.2 | 30 | 25.5 | 41 | 34.8 | 11 | 9.3 | 26 | 22.1 | 14 | 11.9 | 209 | 177.6 |
| AIBONITO | 22 | 82.5 | 5 | 18.8 | 6 | 22.5 | 3 | 11.3 | 3 | 11.3 | 2 | 7.5 | 47 | 176.3 |
| CAYEY | 12 | 25.3 | 13 | 27.4 | 20 | 42.1 | 5 | 10.5 | 15 | 31.6 | 7 | 14.8 | 86 | 181.2 |
| CIDRA | 11 | 25.3 | 12 | 27.6 | 15 | 34.4 | 3 | 6.9 | 8 | 18.4 | 5 | 11.5 | 76 | 174.5 |
| ÁREA DE HUMACAO | 48 | 28.1 | 30 | 17.6 | 71 | 41.6 | 26 | 15.2 | 30 | 17.6 | 39 | 22.8 | 305 | 178.5 |
| HUMACAO | 16 | 26.9 | 13 | 21.9 | 36 | 60.6 | 4 | 6.7 | 11 | 18.5 | 18 | 30.3 | 111 | 186.7 |
| LAS PIEDRAS | 8 | 22.7 | 6 | 17.0 | 10 | 28.4 | 10 | 28.4 | 8 | 22.7 | 2 | 5.7 | 60 | 170.3 |
| MAUNABO | 3 | 23.5 | 4 | 31.3 | 4 | 31.3 | 2 | 15.6 | 2 | 15.6 | 1 | 7.8 | 26 | 203.4 |
| NAGUABO | 8 | 33.5 | 5 | 20.9 | 6 | 25.1 | 2 | 8.4 | 3 | 12.6 | 6 | 25.1 | 49 | 205.3 |
| YABUCOA | 13 | 32.9 | 2 | 5.1 | 15 | 37.9 | 8 | 20.2 | 6 | 15.2 | 12 | 30.4 | 59 | 149.2 |

Tabla 6 - TASAS* DE MORTALIDAD GENERAL POR REGIONES DE SALUD, MUNICIPIO DE RESIDENCIA Y CAUSAS ESPECIFICAS
 Table 6 - GENERAL MORTALITY RATES BY REGIONS OF HEALTH, MUNICIPALITY OF RESIDENCE AND SELECTED CAUSES
 PUERTO RICO, 2001

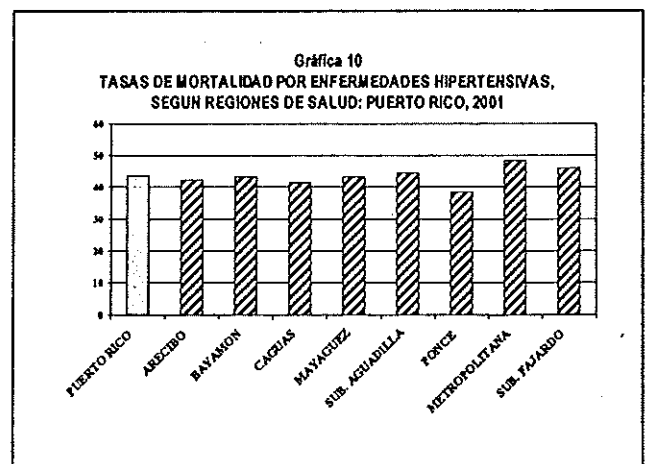
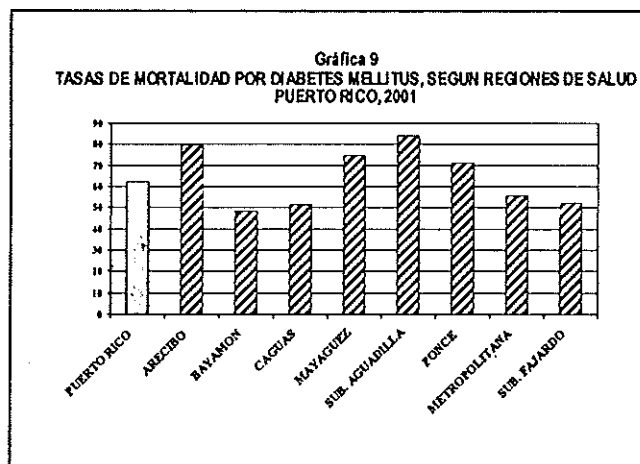
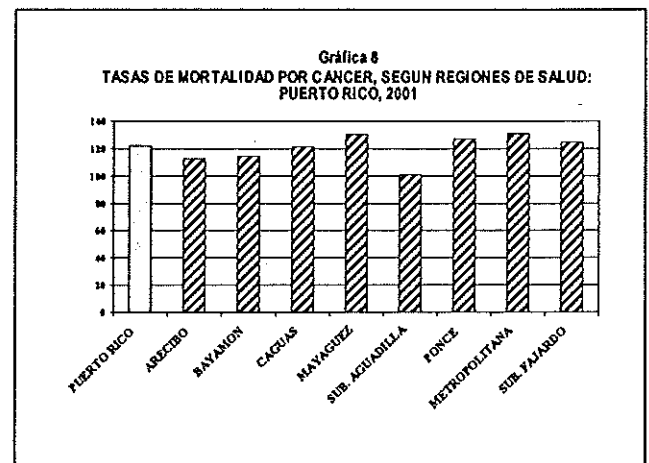
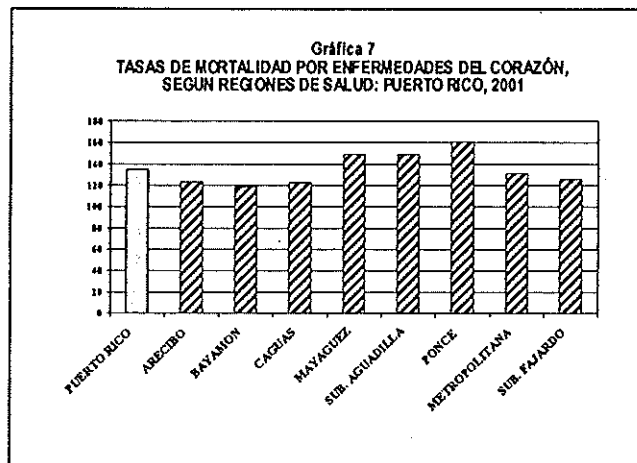
Pag 5 de 6

| MUNICIPIOS MUNICIPALITIES | ENF. PULMONAR OBST. - COPD | | NEUMONIA E INFLUENZA | | HIPERTENSIVAS HIPERTENSIVE | | HOMICIDIOS HOMICIDES | | ENF. HIGADO LIVER DISEAS | | SEPTICEMIA SEPTICAEMIA | | OTRAS CAUSAS OTHER CAUSES | |
|------------------------------|-------------------------------|-------|-------------------------|------|-------------------------------|------|-------------------------|------|-----------------------------|------|---------------------------|------|------------------------------|-------|
| | Núm. | Tasa | Núm. | Tasa | Núm. | Tasa | Núm. | Tasa | Núm. | Tasa | Núm. | Tasa | Núm. | Tasa |
| | REGIÓN MAYAGÜEZ | 66 | 21.0 | 88 | 28.0 | 136 | 43.3 | 17 | 5.4 | 89 | 28.3 | 61 | 19.4 | 710 |
| ÁREA DE MAYAGÜEZ | 55 | 24.5 | 69 | 30.8 | 111 | 49.5 | 15 | 6.7 | 60 | 26.8 | 49 | 21.9 | 495 | 220.7 |
| AÑASCO | 5 | 17.4 | 9 | 31.4 | 27 | 94.1 | 1 | 3.5 | 8 | 27.9 | 7 | 24.4 | 50 | 174.3 |
| CABO ROJO | 12 | 25.1 | 12 | 25.1 | 24 | 50.1 | 4 | 8.4 | 14 | 29.3 | 7 | 14.6 | 119 | 248.6 |
| HORMIGUEROS | 2 | 11.9 | 6 | 35.8 | 4 | 23.9 | 1 | 6.0 | 2 | 11.9 | 3 | 17.9 | 33 | 196.9 |
| LAS MARÍAS | 2 | 17.8 | 5 | 44.4 | 2 | 17.8 | - | - | 1 | 8.9 | 1 | 8.9 | 19 | 168.8 |
| MARICAO | 1 | 15.4 | 1 | 15.4 | 1 | 15.4 | 1 | 15.4 | 2 | 30.9 | 2 | 30.9 | 13 | 200.8 |
| MAYAGÜEZ | 26 | 26.5 | 33 | 33.6 | 46 | 46.9 | 8 | 8.2 | 29 | 29.5 | 23 | 23.4 | 227 | 231.3 |
| RINCÓN | 7 | 46.5 | 3 | 19.9 | 7 | 46.5 | - | - | 4 | 26.6 | 6 | 39.9 | 34 | 225.9 |
| ÁREA DE SAN GERMÁN | 11 | 12.2 | 19 | 21.1 | 25 | 27.7 | 2 | 2.2 | 29 | 32.2 | 12 | 13.3 | 215 | 238.4 |
| LAJAS | 5 | 18.8 | 6 | 22.6 | 7 | 26.3 | 1 | 3.8 | 9 | 33.9 | 4 | 15.0 | 58 | 218.2 |
| SABANA GRANDE | 4 | 15.2 | 7 | 26.6 | 10 | 38.1 | 1 | 3.8 | 2 | 7.6 | 4 | 15.2 | 63 | 239.8 |
| SAN GERMÁN | 2 | 5.4 | 6 | 16.1 | 8 | 21.4 | - | - | 18 | 48.2 | 4 | 10.7 | 94 | 251.8 |
| SUB REGIÓN AGUADILLA | 99 | 41.6 | 63 | 26.4 | 106 | 44.5 | 15 | 6.3 | 47 | 19.7 | 47 | 19.7 | 480 | 201.5 |
| AGUADA | 13 | 30.4 | 14 | 32.8 | 16 | 37.5 | 3 | 7.0 | 9 | 21.1 | 6 | 14.0 | 69 | 161.5 |
| AGUADILLA | 34 | 52.1 | 17 | 26.1 | 31 | 47.5 | 4 | 6.1 | 9 | 13.8 | 14 | 21.5 | 139 | 213.0 |
| ISABELA | 24 | 53.3 | 11 | 24.4 | 24 | 53.3 | 5 | 11.1 | 12 | 26.7 | 8 | 17.8 | 116 | 257.7 |
| MOCA | 17 | 42.0 | 11 | 27.2 | 13 | 32.1 | 1 | 2.5 | 7 | 17.3 | 9 | 22.2 | 62 | 153.2 |
| SAN SEBASTIÁN | 11 | 24.6 | 10 | 22.3 | 22 | 49.1 | 2 | 4.5 | 10 | 22.3 | 10 | 22.3 | 94 | 209.9 |
| REGIÓN PONCE | 153 | 25.6 | 109 | 18.3 | 230 | 38.5 | 108 | 18.1 | 118 | 19.8 | 74 | 12.4 | 1,142 | 191.3 |
| ÁREA DE GUAYAMA | 31 | 26.9 | 18 | 15.6 | 48 | 41.6 | 19 | 16.5 | 27 | 23.4 | 12 | 10.4 | 210 | 182.1 |
| ARROYO | 7 | 36.6 | 2 | 10.5 | 14 | 73.2 | 2 | 10.5 | 5 | 26.1 | 1 | 5.2 | 35 | 182.9 |
| GUAYAMA | 10 | 22.4 | 8 | 17.9 | 14 | 31.4 | 8 | 17.9 | 11 | 24.7 | 7 | 15.7 | 86 | 192.9 |
| PATILLAS | 9 | 44.5 | 5 | 24.7 | 11 | 54.4 | 1 | 4.9 | 7 | 34.6 | 2 | 9.9 | 42 | 207.9 |
| SALINAS | 5 | 15.9 | 3 | 9.6 | 9 | 28.7 | 8 | 25.5 | 4 | 12.7 | 2 | 6.4 | 47 | 149.6 |
| ÁREA DE PONCE | 89 | 24.6 | 68 | 18.8 | 140 | 38.6 | 78 | 21.5 | 71 | 19.6 | 47 | 13.0 | 691 | 190.7 |
| ADJUNTAS | 6 | 31.4 | 5 | 26.2 | 6 | 31.4 | 2 | 10.5 | 2 | 10.5 | 1 | 5.2 | 40 | 209.4 |
| COAMO | 16 | 42.1 | 6 | 15.8 | 14 | 36.8 | 5 | 13.2 | 7 | 18.4 | 8 | 21.1 | 84 | 221.0 |
| JAYUYA | 8 | 45.7 | 2 | 11.4 | 6 | 34.3 | - | - | 2 | 11.4 | 2 | 11.4 | 27 | 154.2 |
| JUANA DÍAZ | 14 | 27.4 | 9 | 17.6 | 15 | 29.4 | 13 | 25.4 | 9 | 17.6 | 4 | 7.8 | 91 | 178.1 |
| PONCE | 36 | 19.3 | 35 | 18.8 | 80 | 42.9 | 47 | 25.2 | 39 | 20.9 | 28 | 15.0 | 357 | 191.6 |
| SANTA ISABEL | 3 | 13.7 | 5 | 22.8 | 12 | 54.7 | 10 | 45.6 | 4 | 18.2 | 3 | 13.7 | 49 | 223.6 |
| VILLALBA | 6 | 21.1 | 6 | 21.1 | 7 | 24.6 | 1 | 3.5 | 8 | 28.2 | 1 | 3.5 | 43 | 151.4 |
| ÁREA DE YAUCO | 33 | 27.6 | 23 | 19.3 | 42 | 35.2 | 11 | 9.2 | 20 | 16.8 | 15 | 12.6 | 241 | 201.9 |
| GUÁNICA | 7 | 31.7 | - | - | 6 | 27.2 | 3 | 13.6 | 2 | 9.1 | 2 | 9.1 | 57 | 258.0 |
| GUAYANILLA | 6 | 25.8 | 7 | 30.1 | 15 | 64.6 | 2 | 8.6 | 5 | 21.5 | 3 | 12.9 | 41 | 176.5 |
| PEÑUELAS | 6 | 22.1 | 1 | 3.7 | 10 | 36.8 | - | - | 5 | 18.4 | 6 | 22.1 | 53 | 195.0 |
| YAUCO | 14 | 29.9 | 15 | 32.0 | 11 | 23.5 | 6 | 12.8 | 8 | 17.1 | 4 | 8.5 | 90 | 192.1 |
| REGIÓN METROPOLITANA | 209 | 23.9 | 248 | 28.3 | 424 | 48.4 | 344 | 39.3 | 169 | 19.3 | 135 | 15.4 | 1,758 | 200.7 |
| ÁREA DE CAROLINA | 73 | 21.4 | 101 | 29.6 | 165 | 48.3 | 117 | 34.3 | 54 | 15.8 | 30 | 8.8 | 581 | 170.2 |
| CANÓVANAS | 13 | 29.5 | 12 | 27.2 | 18 | 40.9 | 18 | 40.9 | 4 | 9.1 | 4 | 9.1 | 67 | 152.1 |
| CAROLINA | 42 | 22.5 | 64 | 34.2 | 100 | 53.5 | 53 | 28.4 | 37 | 19.8 | 14 | 7.5 | 358 | 191.5 |
| LOÍZA | 2 | 6.1 | 6 | 18.2 | 15 | 45.6 | 25 | 76.0 | 4 | 12.2 | 1 | 3.0 | 42 | 127.7 |
| TRUJILLO ALTO | 16 | 20.7 | 19 | 24.5 | 32 | 41.3 | 21 | 27.1 | 9 | 11.6 | 11 | 14.2 | 114 | 147.3 |
| ÁREA DE SAN JUAN | 136 | 25.4 | 147 | 27.5 | 259 | 48.4 | 227 | 42.5 | 115 | 21.5 | 105 | 19.6 | 1,177 | 220.1 |
| GUAYNABO | 22 | 21.8 | 18 | 17.9 | 34 | 33.7 | 28 | 27.8 | 11 | 10.9 | 11 | 10.9 | 185 | 183.5 |
| SAN JUAN | 114 | 26.3 | 129 | 29.7 | 225 | 51.9 | 199 | 45.9 | 104 | 24.0 | 94 | 21.7 | 992 | 228.6 |
| SUB REGIÓN FAJARDO | 26 | 18.1 | 47 | 32.8 | 66 | 46.0 | 27 | 18.8 | 42 | 29.3 | 28 | 19.5 | 304 | 212.0 |
| CEIBA | 1 | 5.5 | 5 | 27.6 | 5 | 27.6 | 3 | 16.6 | 4 | 22.1 | 2 | 11.1 | 31 | 171.3 |
| CULEBRA | 2 | 105.0 | - | - | 1 | 52.5 | - | - | - | - | - | - | 2 | 105.0 |

Tabla 6 - TASAS* DE MORTALIDAD GENERAL POR REGIONES DE SALUD, MUNICIPIO DE RESIDENCIA Y CAUSAS ESPECÍFICAS
 Table 6 - GENERAL MORTALITY RATES BY REGIONS OF HEALTH, MUNICIPALITY OF RESIDENCE AND SELECTED CAUSES
 PUERTO RICO, 2001

Pag 6 de 6

| MUNICIPIOS MUNICIPALITIES | ENF. PULMONAR OBST. - COPD | | NEUMONÍA E INFLUENZA | | HIPERTENSIVAS HIPERTENSIVE | | HOMICIDIOS HOMICIDES | | ENF. HÍGADO LIVER DISEAS | | SEPTICEMIA SEPTICAEMIA | | OTRAS CAUSAS OTHER CAUSES | |
|------------------------------|-------------------------------|------|-------------------------|------|-------------------------------|-------|-------------------------|------|-----------------------------|------|---------------------------|------|------------------------------|-------|
| | Núm. | Tasa | Núm. | Tasa | Núm. | Tasa | Núm. | Tasa | Núm. | Tasa | Núm. | Tasa | Núm. | Tasa |
| | FAJARDO | 13 | 31.6 | 21 | 51.1 | 16 | 38.9 | 10 | 24.3 | 13 | 31.6 | 13 | 31.6 | 93 |
| LUQUILLO | 2 | 10.0 | 8 | 40.0 | 20 | 100.0 | 2 | 10.0 | 6 | 30.0 | 6 | 30.0 | 43 | 215.0 |
| RÍO GRANDE | 6 | 11.3 | 11 | 20.7 | 19 | 35.8 | 11 | 20.7 | 16 | 30.1 | 5 | 9.4 | 114 | 214.7 |
| VIEQUES | 2 | 21.8 | 2 | 21.8 | 5 | 54.6 | 1 | 10.9 | 3 | 32.8 | 2 | 21.8 | 21 | 229.3 |
| P.R. NO ESPECIFICADO | - | - | - | - | - | - | - | - | - | - | - | - | - | - |
| NO RESIDENTE | 2 | - | 2 | - | 10 | - | 3 | - | 3 | - | 3 | - | 34 | - |
| CANADA | - | - | - | - | - | - | - | - | 1 | - | 1 | - | 2 | - |
| CUBA | - | - | - | - | - | - | - | - | - | - | - | - | 1 | - |
| ESTADOS UNIDOS | 1 | - | 1 | - | 7 | - | 3 | - | 2 | - | 1 | - | 13 | - |
| GUAM | - | - | - | - | - | - | - | - | - | - | - | - | - | - |
| ISLAS VÍRGENES | - | - | 1 | - | 2 | - | - | - | - | - | 1 | - | 10 | - |
| MEJICO | - | - | - | - | - | - | - | - | - | - | - | - | - | - |
| REPÚBLICA DOMINICANA | - | - | - | - | 1 | - | - | - | - | - | - | - | 3 | - |
| OTROS PAISES | 1 | - | - | - | - | - | - | - | - | - | - | - | 5 | - |
| DESCONOCIDOS | - | - | 2 | - | - | - | 1 | - | - | - | - | - | 7 | - |

* TASAS POR 100,000 HABITANTES - RATES PER 100,000 HABITANTS

FUENTE: DEPARTAMENTO DE SALUD, SAPEESI, DIVISIÓN DE ESTADÍSTICAS, SAN JUAN, PR.

SOURCE: DEPARTMENT OF HEALTH, ASPESIS, DIVISION OF STATISTICS, SAN JUAN, PR.

Gráfica 11 - DISTRIBUCIÓN PORCENTUAL DE CAUSAS ESPECÍFICAS DE MUERTE
 Chart 11 - PERCENTAGE DISTRIBUTION OF SELECTED DEATH CAUSES
 PUERTO RICO, 2001

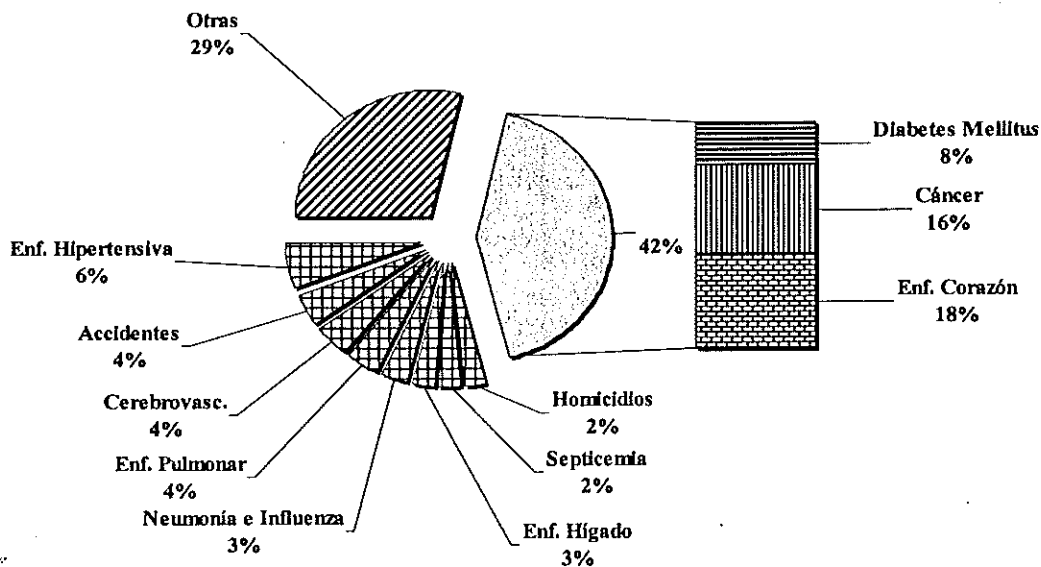

FUENTE: DEPARTAMENTO DE SALUD, SAPEESI, DIVISIÓN DE ESTADÍSTICAS, SAN JUAN, PUERTO RICO
 SOURCE: DEPARTMENT OF HEALTH, ASPESIS, DIVISION OF STATISTICS, SAN JUAN, PUERTO RICO

Gráfica 12 - MUERTES VIOLENTAS* POR AÑOS
Chart 12 - VIOLENT DEATHS BY YEARS
PUERTO RICO, 1960 - 2001

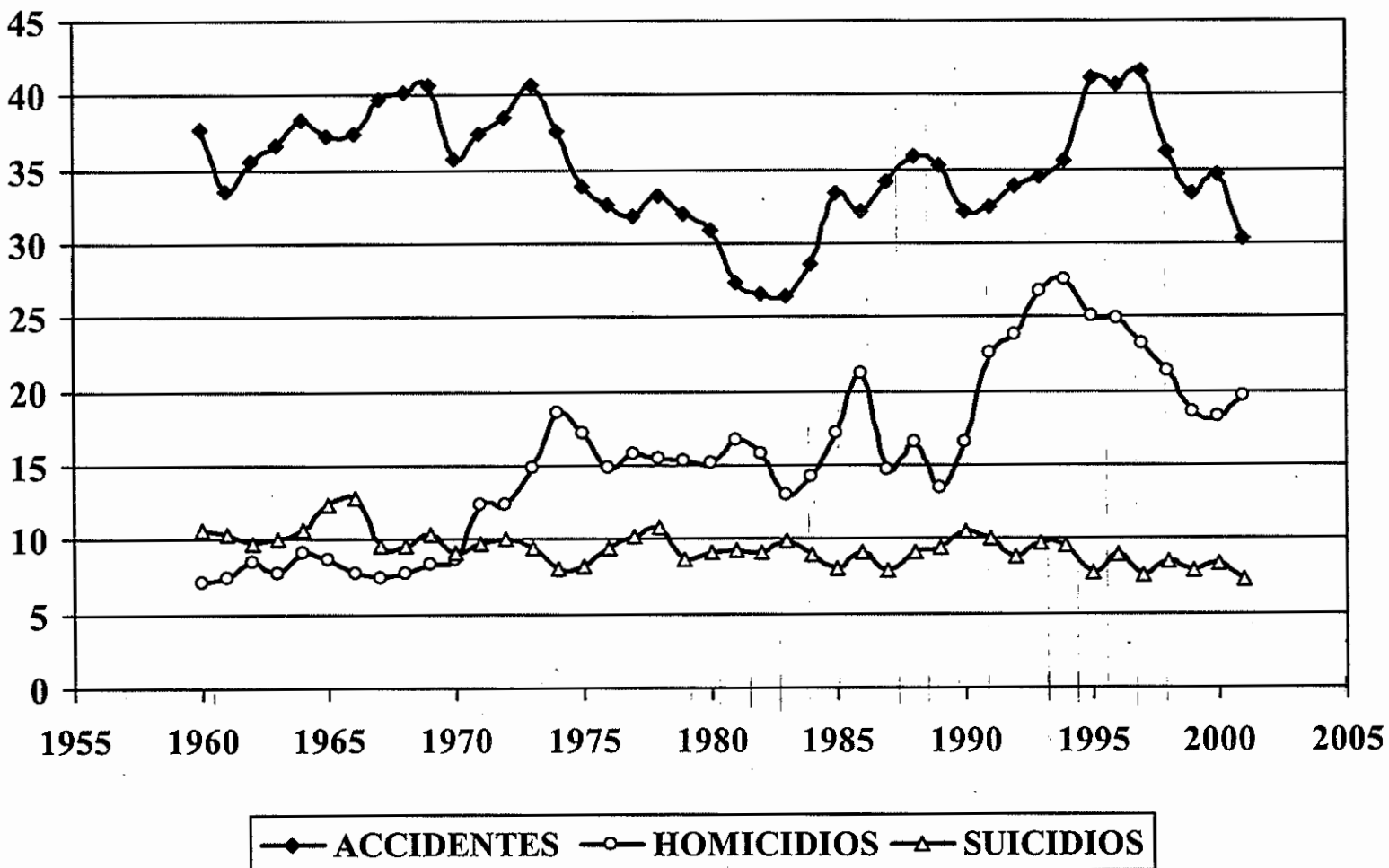

* TASAS POR 100,000 HABITANTES RATES PER 100,000 POPULATION
 FUENTE: DEPARTAMENTO DE SALUD, SAPEESI, DIVISION DE ESTADISTICAS, SAN JUAN, PUERTO RICO
 SOURCE: DEPARTMENT OF HEALTH, ASPEESI, DIVISION OF STATISTICS, SAN JUAN, PUERTO RICO

Tabla 7 - MUERTES VIOLENTAS POR AÑO Y TASAS POR 100,000 HABITANTES
 Table 7 - VIOLENT DEATHS BY YEAR AND RATES BY 100,000 INHABITANTS
 PUERTO RICO, 2001

| AÑOS YEARS | ACCIDENTES ACCIDENTS | | ACCIDENTES DE TRÁNSITO TRAFFIC - ACCIDENTS | | HOMICIDIOS HOMICIDES | | SUICIDIOS SUICIDES | |
|---------------|-------------------------|--------------|---|--------------|-------------------------|--------------|-----------------------|--------------|
| | NÚMERO NUMBER | TASA RATE | NÚMERO NUMBER | TASA RATE | NÚMERO NUMBER | TASA RATE | NÚMERO NUMBER | TASA RATE |
| 2001* | 1,162 | 30.3 | 554 | 14.4 | 752 | 19.6 | 280 | 7.3 |
| 2000* | 1,319 | 34.6 | 622 | 16.3 | 698 | 18.3 | 315 | 8.3 |
| 1999* | 1,269 | 33.4 | 618 | 16.2 | 705 | 18.5 | 299 | 7.9 |
| 1998 | 1,387 | 36.2 | 569 | 14.8 | 819 | 21.4 | 324 | 8.5 |
| 1997 | 1,582 | 41.6 | 623 | 16.4 | 881 | 23.2 | 288 | 7.6 |
| 1996 | 1,520 | 40.7 | 653 | 17.5 | 928 | 24.9 | 331 | 8.9 |
| 1995 | 1,529 | 41.1 | 635 | 17.1 | 928 | 25.0 | 291 | 7.8 |
| 1994 | 1,313 | 35.6 | 631 | 17.1 | 1,017 | 27.6 | 355 | 9.6 |
| 1993 | 1,236 | 34.5 | 611 | 17.1 | 959 | 26.8 | 346 | 9.7 |
| 1992 | 1,209 | 33.8 | 614 | 17.2 | 851 | 23.8 | 314 | 8.8 |
| 1991 | 1,154 | 32.5 | 581 | 16.4 | 803 | 22.6 | 355 | 10.0 |
| 1990 | 1,136 | 32.2 | 548 | 15.5 | 583 | 16.5 | 371 | 10.5 |
| 1989 | 1,235 | 35.3 | 577 | 16.5 | 467 | 13.4 | 327 | 9.4 |
| 1988 | 1,241 | 35.9 | 630 | 18.2 | 576 | 16.6 | 314 | 9.1 |
| 1987 | 1,173 | 34.2 | 652 | 19.0 | 505 | 14.7 | 272 | 7.9 |
| 1986 | 1,096 | 32.2 | 618 | 18.1 | 723 | 21.2 | 310 | 9.1 |
| 1985 | 1,127 | 33.4 | 593 | 17.6 | 579 | 17.1 | 269 | 8.0 |
| 1984 | 958 | 28.6 | 559 | 16.7 | 479 | 14.3 | 300 | 9.0 |
| 1983 | 878 | 26.4 | 533 | 16.0 | 433 | 13.0 | 328 | 9.9 |
| 1982 | 874 | 26.6 | 487 | 14.8 | 517 | 15.7 | 300 | 9.1 |
| 1981 | 891 | 27.4 | 512 | 15.7 | 543 | 16.7 | 302 | 9.3 |
| 1980 | 990 | 30.9 | 554 | 17.3 | 483 | 15.1 | 292 | 9.1 |
| 1979 | 1,010 | 32.0 | 547 | 17.3 | 483 | 15.3 | 274 | 8.7 |
| 1978 | 1,039 | 33.3 | 583 | 18.7 | 485 | 15.5 | 339 | 10.9 |
| 1977 | 980 | 31.9 | 532 | 17.3 | 484 | 15.7 | 314 | 10.2 |
| 1976 | 983 | 32.6 | 510 | 16.9 | 446 | 14.8 | 283 | 9.4 |
| 1975 | 993 | 33.8 | 501 | 17.0 | 502 | 17.1 | 241 | 8.2 |
| 1974 | 1,088 | 37.6 | 597 | 20.7 | 536 | 18.5 | 233 | 8.1 |
| 1973 | 1,169 | 40.7 | 650 | 22.6 | 427 | 14.9 | 270 | 9.4 |
| 1972 | 1,104 | 38.5 | 599 | 20.9 | 352 | 12.3 | 288 | 10.1 |
| 1971 | 1,039 | 37.4 | 538 | 19.4 | 343 | 12.3 | 273 | 9.8 |
| 1970 | 971 | 35.7 | 486 | 17.9 | 236 | 8.7 | 251 | 9.2 |
| 1969 | 1,100 | 40.7 | 524 | 19.4 | 224 | 8.3 | 279 | 10.3 |
| 1968 | 1,071 | 40.2 | 566 | 21.2 | 206 | 7.7 | 255 | 9.6 |
| 1967 | 1,048 | 39.8 | 494 | 18.6 | 196 | 7.4 | 252 | 9.6 |
| 1966 | 978 | 37.4 | 424 | 16.2 | 202 | 7.7 | 334 | 12.8 |
| 1965 | 964 | 37.3 | 441 | 17.1 | 222 | 8.6 | 318 | 12.3 |
| 1964 | 974 | 38.3 | 450 | 17.7 | 231 | 9.1 | 269 | 10.6 |
| 1963 | 914 | 36.7 | 424 | 17.0 | 195 | 7.8 | 248 | 10.0 |
| 1962 | 868 | 35.5 | 368 | 15.0 | 207 | 8.5 | 237 | 9.7 |

* INCLUYE TIPO DE MUERTE NO ESPECIFICADO - INCLUDES TYPE OF DEATH UNSPECIFIED

FUENTE: DEPARTAMENTO DE SALUD, SAPEESI, DIVISIÓN DE ESTADÍSTICAS, SAN JUAN, PUERTO RICO.

SOURCE: DEPARTMENT OF HEALTH, ASPESIS, DIVISION OF STATISTICS, SAN JUAN, PUERTO RICO.

Tabla 8 - MUERTES VIOLENTAS POR GRUPO DE EDAD Y TASAS
 Table 8 - VIOLENT DEATHS BY AGE GROUPS AND RATES
 PUERTO RICO, 2001

| AÑOS YEARS | ACCIDENTES ACCIDENTS | | HOMICIDIOS HOMICIDES | | SUICIDIOS SUICIDES | | SIN DETERMINAR UNDETERMINED | |
|--------------------|-------------------------|--------------|-------------------------|--------------|-----------------------|--------------|--------------------------------|--------------|
| | NÚMERO NUMBER | TASA RATE | NÚMERO NUMBER | TASA RATE | NÚMERO NUMBER | TASA RATE | NÚMERO NUMBER | TASA RATE |
| TOTAL | 1,162 | 30.3 | 752 | 19.6 | 280 | 7.3 | 59 | 1.5 |
| < 1 AÑO - < 1 YEAR | 1 | 0.2 | 5 | 0.9 | - | - | - | - |
| 1 | 4 | 0.7 | 1 | 0.2 | - | - | - | - |
| 2 | 1 | 0.2 | - | - | - | - | - | - |
| 3 | 5 | 0.8 | 2 | 0.3 | - | - | - | - |
| 4 | 3 | 0.5 | - | - | - | - | - | - |
| 5 - 9 | 12 | 0.4 | 2 | 0.1 | - | - | - | - |
| 10 - 14 | 27 | 0.9 | 5 | 0.2 | 2 | 0.1 | 1 | - |
| 15 - 19 | 69 | 2.2 | 102 | 3.3 | 12 | 0.4 | 6 | 0.2 |
| 20 - 24 | 123 | 4.1 | 215 | 7.1 | 29 | 1 | 3 | 0.1 |
| 25 - 29 | 89 | 3.2 | 169 | 6.2 | 25 | 0.9 | 7 | 0.3 |
| 30 - 34 | 97 | 3.7 | 75 | 2.9 | 20 | 0.8 | 2 | 0.1 |
| 35 - 39 | 104 | 3.9 | 47 | 1.8 | 24 | 0.9 | 5 | 0.2 |
| 40 - 44 | 84 | 3.3 | 39 | 1.5 | 27 | 1.1 | 10 | 0.4 |
| 45 - 49 | 86 | 3.6 | 28 | 1.2 | 32 | 1.4 | 4 | 0.2 |
| 50 - 54 | 71 | 3 | 21 | 0.9 | 21 | 0.9 | 5 | 0.2 |
| 55 - 59 | 67 | 3.4 | 15 | 0.8 | 21 | 1.1 | 2 | 0.1 |
| 60 - 64 | 49 | 3 | 9 | 0.5 | 17 | 1 | 4 | 0.2 |
| 65 - 69 | 45 | 3.3 | 4 | 0.3 | 17 | 1.2 | 2 | 0.1 |
| 70 - 74 | 40 | 3.7 | 3 | 0.3 | 10 | 0.9 | 1 | 0.1 |
| 75 - 79 | 42 | 5 | 3 | 0.4 | 10 | 1.2 | 1 | 0.1 |
| 80 - 84 | 38 | 6.8 | 3 | 0.5 | 8 | 1.4 | 2 | 0.4 |
| 85+ | 103 | 20.7 | 2 | 0.4 | 5 | 1 | 2 | 0.4 |
| SIN ESP (UNSP AGE) | 2 | - | 2 | - | - | - | 2 | - |

FUENTE: DEPARTAMENTO DE SALUD, SAPEESI, DIVISIÓN DE ESTADÍSTICAS, SAN JUAN, PUERTO RICO.

SOURCE: DEPARTMENT OF HEALTH, ASPESI, DIVISION OF STATISTICS, SAN JUAN, PUERTO RICO.

Tabla 9 - DEFUNCIONES POR OCUPACIÓN, GRUPOS DE EDAD Y SEXO
 Table 9 - DEATHS BY OCCUPATION, AGE GROUPS AND SEX
 PUERTO RICO, 2001

Pag 1 de 4

| OCUPACIÓN - OCCUPATION | TOTALES | | | < 15 | | | 15 - 19 | | | 20 - 24 | | | 25 - 29 | | |
|---|---------------|-----------------|-------------------|------------|-----------------|-------------------|------------|-----------------|-------------------|------------|-----------------|-------------------|------------|-----------------|-------------------|
| | TOTAL | HOMBRES - MALES | MUJERES - FEMALES | TOTAL | HOMBRES - MALES | MUJERES - FEMALES | TOTAL | HOMBRES - MALES | MUJERES - FEMALES | TOTAL | HOMBRES - MALES | MUJERES - FEMALES | TOTAL | HOMBRES - MALES | MUJERES - FEMALES |
| TOTAL | 28,794 | 16,235 | 12,559 | 658 | 392 | 266 | 251 | 207 | 44 | 465 | 383 | 82 | 419 | 329 | 90 |
| PROFESIONALES, TÉCNICOS AFIN PROFESSIONAL, TECH & KINDRED WORKERS | 1,538 | 925 | 613 | - | - | - | - | - | - | 4 | 3 | 1 | 19 | 13 | 6 |
| MÉDICOS Y DENTISTAS PHYSICIAN & DENTIST | 72 | 60 | 12 | - | - | - | - | - | - | - | - | - | 1 | 1 | - |
| AGRICULTORES Y ADMINIS. DE FINCAS FARMERS, FARM MANAGER | 1,539 | 1,529 | 10 | - | - | - | 2 | 2 | - | 1 | 1 | - | 10 | 10 | - |
| ADM.GERENTES, PROPIETARIOS EXCEPTO FINCAS MANAGER, EXCEPT FARM | 2,409 | 2,100 | 309 | - | - | - | - | - | - | 8 | 7 | 1 | 21 | 18 | 3 |
| OFICINISTAS Y TRABAJADORES AFINES CLERICAL & KINDRED WORKERS | 896 | 386 | 510 | - | - | - | 4 | 4 | - | 20 | 17 | 3 | 13 | 4 | 9 |
| VENEDORES SALES WORKERS | 558 | 493 | 65 | - | - | - | 3 | 3 | - | 18 | 15 | 3 | 16 | 15 | 1 |
| ARTESANOS, CAPATACES, TRABAJADORES AFINES CRAFTSMEN, & KINDRED WORKERS | 2,336 | 2,296 | 40 | - | - | - | 10 | 10 | - | 34 | 34 | - | 38 | 38 | - |
| OPERARIOS Y TRABAJ. AFIN OPERATIVES AND KINDRED WORKERS | 3,244 | 2,513 | 731 | - | - | - | 6 | 6 | - | 32 | 29 | 3 | 45 | 43 | 2 |
| TRABAJADORES DE SERVICIOS SERVICE WORKERS | 3,147 | 2,268 | 879 | - | - | - | 17 | 17 | - | 73 | 67 | 6 | 66 | 54 | 12 |
| OBRAERO AGRÍCOLA Y MAYORDOMO O CAPATAZ FARM, LABORER, FOREMAN | 663 | 653 | 10 | - | - | - | - | - | - | - | - | - | - | - | - |
| OBRAERO, EXC. FNCA, MINA LABORER, EX. FARM, MINE | 1,568 | 1,553 | 15 | - | - | - | 14 | 14 | - | 73 | 72 | 1 | 53 | 53 | - |
| ESTUDIANTES STUDENTS | 203 | 140 | 63 | 51 | 34 | 17 | 91 | 66 | 25 | 44 | 28 | 16 | 12 | 8 | 4 |
| SIN ESPECIFICAR UNSPECIFIED | 10,621 | 1,319 | 9,302 | 607 | 358 | 249 | 104 | 85 | 19 | 158 | 110 | 48 | 125 | 72 | 53 |

Tabla 9 - DEFUNCIONES POR OCUPACIÓN, GRUPOS DE EDAD Y SEXO
 Table 9 - DEATHS BY OCCUPATION, AGE GROUPS AND SEX
 PUERTO RICO, 2001

Pag 2 de 4

| OCUPACIÓN - OCCUPATION | 30 - 34 | | | 35 - 39 | | | 40 - 44 | | | 45 - 49 | | | 50 - 54 | | |
|---|------------|-----------------|-------------------|------------|-----------------|-------------------|------------|-----------------|-------------------|------------|-----------------|-------------------|--------------|-----------------|-------------------|
| | TOTAL | HOMBRES - MALES | MUJERES - FEMALES | TOTAL | HOMBRES - MALES | MUJERES - FEMALES | TOTAL | HOMBRES - MALES | MUJERES - FEMALES | TOTAL | HOMBRES - MALES | MUJERES - FEMALES | TOTAL | HOMBRES - MALES | MUJERES - FEMALES |
| TOTAL | 440 | 330 | 110 | 582 | 417 | 165 | 755 | 554 | 201 | 925 | 632 | 293 | 1,256 | 850 | 406 |
| PROFESIONALES, TÉCNICOS AFIN PROFESSIONAL, TECH & KINDRED WORKERS | 17 | 14 | 3 | 28 | 16 | 12 | 58 | 30 | 28 | 69 | 39 | 30 | 93 | 58 | 35 |
| MÉDICOS Y DENTISTAS PHYSICIAN & DENTIST | - | - | - | 2 | 2 | - | 1 | - | 1 | 9 | 8 | 1 | 5 | 4 | 1 |
| AGRICULTORES Y ADMINIS. DE FINCAS FARMERS, FARM MANAGER | 2 | 2 | - | 4 | 4 | - | 12 | 12 | - | 17 | 17 | - | 24 | 24 | - |
| ADM. GERENTES, PROPIETARIOS EXCEPT FINCAS MANAGER, EXCEPT FARM | 19 | 17 | 2 | 39 | 35 | 4 | 49 | 41 | 8 | 65 | 57 | 8 | 117 | 101 | 16 |
| OFICINISTAS Y TRABAJADORES AFINES CLERICAL & KINDRED WORKERS | 19 | 12 | 7 | 29 | 5 | 24 | 29 | 11 | 18 | 52 | 20 | 32 | 64 | 25 | 39 |
| VENDEDORES SALES WORKERS | 13 | 10 | 3 | 12 | 10 | 2 | 19 | 17 | 2 | 19 | 14 | 5 | 36 | 31 | 5 |
| ARTESANOS, CAPATACES, TRABAJADORES AFINES CRAFTSMEN, & KINDRED WORKERS | 49 | 48 | 1 | 57 | 56 | 1 | 96 | 95 | 1 | 117 | 116 | 1 | 156 | 154 | 2 |
| OPERARIOS, TRAB. AFIN OPERATIVES AND KINDRED WORKERS | 41 | 36 | 5 | 62 | 58 | 4 | 88 | 80 | 8 | 113 | 101 | 12 | 171 | 138 | 33 |
| TRABAJADORES DE SERVICIOS SERVICE WORKERS | 51 | 41 | 10 | 80 | 62 | 18 | 94 | 79 | 15 | 125 | 93 | 32 | 159 | 125 | 34 |
| OBROERO AGRÍCOLA Y MAYORDOMO O CAPATAZ FARM, LABORER, FOREMAN | 4 | 4 | - | 8 | 8 | - | 7 | 7 | - | 15 | 15 | - | 20 | 19 | 1 |
| OBROERO, EXC. FNCA, MINA LABORER, EX. FARM, MINE | 71 | 70 | 1 | 87 | 87 | - | 105 | 104 | 1 | 100 | 99 | 1 | 112 | 110 | 2 |
| ESTUDIANTES STUDENTS | 1 | 1 | - | 2 | 1 | 1 | - | - | - | 1 | 1 | - | 1 | 1 | - |
| SIN ESPECIFICAR UNSPECIFIED | 153 | 75 | 78 | 172 | 73 | 99 | 197 | 78 | 119 | 223 | 52 | 171 | 298 | 60 | 238 |

Tabla 9 - DEFUNCIONES POR OCUPACIÓN, GRUPOS DE EDAD Y SEXO
 Table 9 - DEATHS BY OCCUPATION, AGE GROUPS AND SEX
 PUERTO RICO, 2001

Pag 3 de 4

| OCUPACIÓN - OCCUPATION | 55 - 59 | | | 60 - 64 | | | 65 - 69 | | | 70 - 74 | | |
|---|--------------|-----------------|-------------------|--------------|-----------------|-------------------|--------------|-----------------|-------------------|--------------|-----------------|-------------------|
| | TOTAL | HOMBRES - MALES | MUJERES - FEMALES | TOTAL | HOMBRES - MALES | MUJERES - FEMALES | TOTAL | HOMBRES - MALES | MUJERES - FEMALES | TOTAL | HOMBRES - MALES | MUJERES - FEMALES |
| TOTAL | 1,670 | 1068 | 602 | 1,957 | 1,209 | 748 | 2,459 | 1,444 | 1,015 | 2,903 | 1,673 | 1,230 |
| PROFESIONALES, TÉCNICOS AFIN PROFESSIONAL, TECH & KINDRED WORKERS | 106 | 68 | 38 | 120 | 79 | 41 | 167 | 105 | 62 | 175 | 125 | 50 |
| MÉDICOS Y DENTISTAS PHYSICIAN & DENTIST | 5 | 5 | - | 3 | 2 | 1 | 2 | 2 | - | 11 | 9 | 2 |
| AGRICULTORES Y ADMINISTRADORES DE FINCAS FARMERS, FARM MANAGER | 40 | 40 | - | 66 | 65 | 1 | 89 | 89 | - | 137 | 137 | - |
| ADM. GERENTES, PROPIETARIOS EXCEPTO FINCAS MANAGER, EXCEPT FARM | 148 | 133 | 15 | 170 | 150 | 20 | 263 | 226 | 37 | 292 | 265 | 27 |
| OFICINISTAS Y TRABAJADORES AFINES CLERICAL & KINDRED WORKERS | 62 | 22 | 40 | 75 | 36 | 39 | 96 | 39 | 57 | 90 | 44 | 46 |
| VENDEDORES SALES WORKERS | 51 | 47 | 4 | 45 | 39 | 6 | 43 | 35 | 8 | 60 | 55 | 5 |
| ARTESANOS, CAPATACES, TRABAJADORES AFINES CRAFTSMEN, & KINDRED WORKERS | 182 | 176 | 6 | 214 | 210 | 4 | 245 | 241 | 4 | 238 | 236 | 2 |
| OPERARIOS Y TRABAJADORES AFINES OPERATIVES AND KINDRED WORKERS | 270 | 220 | 50 | 300 | 231 | 69 | 335 | 277 | 58 | 381 | 299 | 82 |
| TRABAJADORES DE SERVICIOS SERVICE WORKERS | 233 | 167 | 66 | 272 | 201 | 71 | 348 | 250 | 98 | 377 | 271 | 106 |
| OBRAERO AGRÍCOLA Y MAYORDOMO O CAPATAZ FARM, LABORER, FOREMAN | 33 | 33 | - | 32 | 32 | - | 39 | 39 | - | 50 | 50 | - |
| OBRAERO, EXC. FNCA, MINA LABORER, EX. FARM, MINE | 105 | 105 | - | 117 | 117 | - | 102 | 102 | - | 124 | 121 | 3 |
| ESTUDIANTES STUDENTS | - | - | - | - | - | - | - | - | - | - | - | - |
| SIN ESPECIFICAR UNSPECIFIED | 435 | 52 | 383 | 543 | 47 | 496 | 730 | 39 | 691 | 968 | 61 | 907 |

Tabla 9 - DEFUNCIONES POR OCUPACIÓN, GRUPOS DE EDAD Y SEXO
 Table 9 - DEATHS BY OCCUPATION, AGE GROUPS AND SEX
 PUERTO RICO, 2001

Pag 4 de 4

| OCUPACIÓN - OCCUPATION | 75 - 79 | | | 80 - 84 | | | 85 y más | | | Sin Determinar | | |
|---|--------------|-----------------|-------------------|--------------|-----------------|-------------------|--------------|-----------------|-------------------|----------------|-----------------|-------------------|
| | TOTAL | HOMBRES - MALES | MUJERES - FEMALES | TOTAL | HOMBRES - MALES | MUJERES - FEMALES | TOTAL | HOMBRES - MALES | MUJERES - FEMALES | TOTAL | HOMBRES - MALES | MUJERES - FEMALES |
| TOTAL | 3,657 | 1,931 | 1,726 | 3,798 | 1,908 | 1,890 | 6,568 | 2,885 | 3,683 | 31 | 23 | 8 |
| PROFESIONALES, TÉCNICOS AFIN PROFESSIONAL, TECH & KINDRED WORKERS | 213 | 136 | 77 | 169 | 100 | 69 | 300 | 139 | 161 | - | - | - |
| MÉDICOS Y DENTISTAS PHYSICIAN & DENTIST | 15 | 12 | 3 | 7 | 7 | - | 11 | 8 | 3 | - | - | - |
| AGRICULTORES Y ADMINIS. DE FINCAS FARMERS, FARM MANAGER | 226 | 225 | 1 | 257 | 255 | 2 | 652 | 646 | 6 | - | - | - |
| ADM. GERENTES, PROPIETARIOS EXCEPT FINCAS MANAGER, EXCEPT FARM | 325 | 280 | 45 | 365 | 311 | 54 | 527 | 458 | 69 | 1 | 1 | - |
| OFICINISTAS Y TRABAJADORES AFINES CLERICAL & KINDRED WORKERS | 109 | 57 | 52 | 100 | 47 | 53 | 133 | 43 | 90 | 1 | - | 1 |
| VENDEDORES SALES WORKERS | 72 | 66 | 6 | 57 | 51 | 6 | 94 | 85 | 9 | - | - | - |
| ARTESANOS, CAPATACES, TRABAJADORES AFINES CRAFTSMEN, & KINDRED WORKERS | 282 | 277 | 5 | 286 | 283 | 3 | 330 | 320 | 10 | 2 | 2 | - |
| OPERARIOS, TRABAFIN OPERATIVES AND KINDRED WORKERS | 449 | 334 | 115 | 411 | 315 | 96 | 540 | 346 | 194 | - | - | - |
| TRABAJADORES DE SERVICIOS SERVICE WORKERS | 412 | 285 | 127 | 365 | 250 | 115 | 474 | 306 | 168 | 1 | - | 1 |
| OBRERO AGRÍCOLA Y MAYORDOMO O CAPATAZ FARM, LABORER, FOREMAN | 86 | 83 | 3 | 115 | 115 | - | 254 | 248 | 6 | - | - | - |
| OBRERO, EXC. FNCA, MINA LABORER, EX. FARM, MINE | 130 | 127 | 3 | 131 | 130 | 1 | 243 | 241 | 2 | 1 | 1 | - |
| ESTUDIANTES STUDENTS | - | - | - | - | - | - | - | - | - | - | - | - |
| SIN ESPECIFICAR UNSPECIFIED | 1,338 | 49 | 1,289 | 1,535 | 44 | 1,491 | 3,010 | 45 | 2,965 | 25 | 19 | 6 |

FUENTE: DEPARTAMENTO DE SALUD, SAPEESI, DIVISIÓN DE ESTADÍSTICAS, SAN JUAN, PUERTO RICO.

SOURCE: DEPARTMENT OF HEALTH, ASPESIS, DIVISION OF STATISTICS, SAN JUAN, PUERTO RICO.

Tabla 10 - MUERTES FETALES POR MES Y SEXO
 Table 10 - FETAL DEATHS BY MONTH AND SEX
 PUERTO RICO, 2001

| MES MONTH | 2001 | | | 2000 | | | 1999 | | |
|-------------------------|-------|------------------|--------------------|-------|------------------|--------------------|-------|------------------|--------------------|
| | TOTAL | HOMBRES MALES | MUJERES FEMALES | TOTAL | HOMBRES MALES | MUJERES FEMALES | TOTAL | HOMBRES MALES | MUJERES FEMALES |
| TOTAL | * 584 | 318 | 263 | * 651 | 363 | 286 | * 684 | 354 | 328 |
| ENERO JANUARY | * 50 | 24 | 23 | 53 | 35 | 18 | 47 | 29 | 18 |
| FEBRERO FEBRUARY | 46 | 31 | 15 | 41 | 20 | 21 | 46 | 24 | 22 |
| MARZO MARCH | 44 | 20 | 24 | 49 | 31 | 18 | * 56 | 23 | 32 |
| ABRIL APRIL | 46 | 23 | 23 | * 44 | 27 | 16 | 54 | 34 | 20 |
| MAYO MAY | 53 | 24 | 29 | 63 | 22 | 41 | 54 | 30 | 24 |
| JUNIO JUNE | 45 | 23 | 22 | 54 | 28 | 26 | 67 | 27 | 40 |
| JULIO JULY | 57 | 29 | 28 | 73 | 44 | 29 | 45 | 29 | 16 |
| AGOSTO AUGUST | 51 | 29 | 22 | 68 | 39 | 29 | 70 | 43 | 27 |
| SEPTIEMBRE SEPTEMBER | 49 | 30 | 19 | * 58 | 30 | 27 | * 61 | 30 | 30 |
| OCTUBRE OCTOBER | 43 | 25 | 18 | 48 | 33 | 15 | 72 | 26 | 46 |
| NOVIEMBRE NOVEMBER | 53 | 31 | 22 | 57 | 32 | 25 | 55 | 32 | 23 |
| DICIEMBRE DECEMBER | 47 | 29 | 18 | 43 | 22 | 21 | 57 | 27 | 30 |

*TOTAL INCLUYE SEXO NO ESPECIFICADO

TOTAL INCLUDES UNSPECIFIED SEX

FUENTE: DEPARTAMENTO DE SALUD, SAPEESI, DIVISIÓN DE ESTADÍSTICAS, SAN JUAN, PUERTO RICO.

SOURCE: DEPARTMENT OF HEALTH, ASPESIS, DIVISION OF STATISTICS, SAN JUAN, PUERTO RICO.

Tabla 11 - MUERTES FETALES POR MUNICIPIO DE OCURRENCIA, MUNICIPIO DE RESIDENCIA Y TASA
 Table 11 - FETAL DEATHS AND RATES BY MUNICIPALITIES OF RESIDENCE AND OCCURRENCE
 PUERTO RICO, 2001

Pag 1 de 3

| MUNICIPIOS MUNICIPALITIES | OCURRENCIA OCCURRENCE | | RESIDENCIA RESIDENCE | |
|------------------------------|--------------------------|---------------|-------------------------|---------------|
| | NÚMERO NUMBER | TASA* RATE | NÚMERO NUMBER | TASA* RATE |
| TOTAL | 584 | 10.4 | 584 | 10.4 |
| REGIÓN ARECIBO | 55 | 7.8 | 69 | 9.8 |
| ÁREA DE ARECIBO | 24 | 6.4 | 32 | 8.5 |
| ARECIBO | 24 | 17.2 | 14 | 10.1 |
| CAMUY | 0 | 0.0 | 0 | 0.0 |
| HATILLO | 0 | 0.0 | 7 | 13.1 |
| LARES | 0 | 0.0 | 2 | 4.3 |
| QUEBRADILLAS | 0 | 0.0 | 7 | 18.4 |
| UTUADO | 0 | 0.0 | 2 | 3.9 |
| ÁREA DE MANATÍ | 31 | 9.5 | 37 | 11.3 |
| BARCELONETA | 0 | 0.0 | 6 | 15.5 |
| CIALES | 0 | 0.0 | 3 | 10.0 |
| FLORIDA | 0 | 0.0 | 1 | 5.1 |
| MANATÍ | 30 | 39.3 | 8 | 10.8 |
| MOROVIS | 0 | 0.0 | 9 | 16.4 |
| VEGA BAJA | 1 | 0.9 | 10 | 9.2 |
| REGIÓN BAYAMÓN | 69 | 7.3 | 88 | 9.3 |
| ÁREA BARRANQUITAS | 0 | 0.0 | 11 | 5.1 |
| BARRANQUITAS | 0 | 0.0 | 2 | 4.4 |
| COMERÍO | 0 | 0.0 | 1 | 3.5 |
| COROZAL | 0 | 0.0 | 5 | 8.7 |
| NARANJITO | 0 | 0.0 | 2 | 4.6 |
| OROCOVIS | 0 | 0.0 | 1 | 2.6 |
| ÁREA DE BAYAMÓN | 69 | 14.2 | 50 | 10.3 |
| BAYAMÓN | 69 | 20.8 | 35 | 10.6 |
| TOA ALTA | 0 | 0.0 | 10 | 10.6 |
| VEGA ALTA | 0 | 0.0 | 5 | 8.3 |
| ÁREA DE CATAÑO | 0 | 0.0 | 27 | 10.9 |
| CATAÑO | 0 | 0.0 | 0 | 0.0 |
| DORADO | 0 | 0.0 | 8 | 14.4 |
| TOA BAJA | 0 | 0.0 | 19 | 13.3 |
| REGIÓN DE CAGUAS | 64 | 7.5 | 83 | 9.7 |
| ÁREA DE CAGUAS | 35 | 8.3 | 39 | 9.2 |
| AGUAS BUENAS | 0 | 0.0 | 3 | 7.0 |
| CAGUAS | 35 | 16.2 | 24 | 11.2 |
| GURABO | 0 | 0.0 | 1 | 1.9 |
| JUNCOS | 0 | 0.0 | 2 | 3.4 |
| SAN LORENZO | 0 | 0.0 | 9 | 17.0 |
| ÁREA DE CAYEY | 7 | 3.9 | 15 | 8.3 |
| AIBONITO | 3 | 6.7 | 0 | 0.0 |
| CAYEY | 4 | 5.4 | 9 | 12.2 |
| CIDRA | 0 | 0.0 | 6 | 9.6 |

Tabla 11 - MUERTES FETALES POR MUNICIPIO DE OCURRENCIA, MUNICIPIO DE RESIDENCIA Y TASA
 Table 11 - FETAL DEATHS AND RATES BY MUNICIPALITIES OF RESIDENCE AND OCCURRENCE
 PUERTO RICO, 2001

Pag 2 de 3

| MUNICIPIOS MUNICIPALITIES | OCURRENCIA OCCURRENCE | | RESIDENCIA RESIDENCE | |
|------------------------------|--------------------------|---------------|-------------------------|---------------|
| | NÚMERO NUMBER | TASA* RATE | NÚMERO NUMBER | TASA* RATE |
| ÁREA DE HUMACAO | 22 | 8.8 | 29 | 11.6 |
| HUMACAO | 21 | 23.4 | 11 | 12.4 |
| LAS PIEDRAS | 0 | 0.0 | 8 | 15.6 |
| MAUNABO | 0 | 0.0 | 1 | 5.6 |
| NAGUABO | 0 | 0.0 | 4 | 11.1 |
| YABUCOA | 1 | 1.8 | 5 | 8.9 |
| REGIÓN MAYAGÜEZ | 51 | 12.7 | 45 | 11.2 |
| ÁREA DE MAYAGÜEZ | 42 | 14.6 | 36 | 12.6 |
| AÑASCO | 0 | 0.0 | 2 | 5.1 |
| CABO ROJO | 0 | 0.0 | 10 | 16.5 |
| HORMIGUEROS | 0 | 0.0 | 2 | 9.6 |
| LAS MARIAS | 0 | 0.0 | 5 | 34.5 |
| MARICAO | 0 | 0.0 | 1 | 12.2 |
| MAYAGÜEZ | 42 | 33.8 | 14 | 11.5 |
| RINCÓN | 0 | 0.0 | 2 | 9.1 |
| ÁREA DE SAN GERMÁN | 9 | 7.9 | 9 | 7.9 |
| LAJAS | 0 | 0.0 | 5 | 15.2 |
| SABANA GRANDE | 0 | 0.0 | 1 | 2.9 |
| SAN GERMÁN | 9 | 19.0 | 3 | 6.4 |
| SUB REGIÓN AGUADILLA | 27 | 8.5 | 38 | 11.9 |
| AGUADA | 0 | 0.0 | 5 | 8.5 |
| AGUADILLA | 15 | 19.1 | 16 | 20.4 |
| ISABELA | 0 | 0.0 | 5 | 8.3 |
| MOCA | 11 | 17.9 | 6 | 9.8 |
| SAN SEBASTIÁN | 1 | 1.7 | 6 | 10.1 |
| REGIÓN PONCE | 94 | 10.1 | 98 | 10.5 |
| ÁREA DE GUAYAMA | 14 | 7.8 | 22 | 12.3 |
| ARROYO | 0 | 0.0 | 5 | 17.1 |
| GUAYAMA | 14 | 18.6 | 11 | 14.6 |
| PATILLAS | 0 | 0.0 | 1 | 3.7 |
| SALINAS | 0 | 0.0 | 5 | 10.4 |
| ÁREA DE PONCE | 73 | 12.6 | 60 | 10.4 |
| ADJUNTAS | 0 | 0.0 | 2 | 6.2 |
| COAMO | 0 | 0.0 | 6 | 10.5 |
| JAYUYA | 0 | 0.0 | 1 | 3.6 |
| JUANA DÍAZ | 0 | 0.0 | 8 | 9.5 |
| PONCE | 73 | 25.1 | 38 | 13.2 |
| SANTA ISABEL | 0 | 0.0 | 3 | 7.3 |
| VILLALBA | 0 | 0.0 | 2 | 4.3 |
| ÁREA DE YAUCO | 7 | 4.0 | 16 | 9.1 |
| GUÁNICA | 0 | 0.0 | 3 | 10.6 |
| GUAYANILLA | 1 | 2.7 | 5 | 13.5 |
| PEÑUELAS | 0 | 0.0 | 6 | 12.6 |
| YAUCO | 6 | 9.4 | 2 | 3.1 |

Tabla 11 - MUERTES FETALES POR MUNICIPIO DE OCURRENCIA, MUNICIPIO DE RESIDENCIA Y TASA
 Table 11 - FETAL DEATHS AND RATES BY MUNICIPALITIES OF RESIDENCE AND OCCURRENCE
 PUERTO RICO, 2001

Pag 3 de 3

| MUNICIPIOS MUNICIPALITIES | OCURRENCIA OCCURRENCE | | RESIDENCIA RESIDENCE | |
|------------------------------|--------------------------|---------------|-------------------------|---------------|
| | NÚMERO NUMBER | TASA* RATE | NÚMERO NUMBER | TASA* RATE |
| REGIÓN METROPOLITANA | 209 | 16.3 | 119 | 9.4 |
| ÁREA DE CAROLINA | 21 | 4.2 | 54 | 10.8 |
| CANÓVANAS | 0 | 0.0 | 10 | 13.2 |
| CAROLINA | 20 | 7.2 | 29 | 10.5 |
| LOIZA | 0 | 0.0 | 4 | 9.2 |
| TRUJILLO ALTO | 1 | 1.0 | 11 | 10.4 |
| ÁREA DE SAN JUAN | 188 | 24.1 | 65 | 8.5 |
| GUAYNABO | 0 | 0.0 | 13 | 9.3 |
| SAN JUAN | 188 | 29.4 | 52 | 8.3 |
| SUB REGIÓN FAJARDO | 15 | 6.9 | 29 | 13.2 |
| CEIBA | 0 | 0.0 | 1 | 3.7 |
| CULEBRA | 0 | 0.0 | 0 | 0.0 |
| FAJARDO | 15 | 24.6 | 9 | 14.9 |
| LUQUILLO | 0 | 0.0 | 3 | 9.0 |
| RÍO GRANDE | 0 | 0.0 | 13 | 15.7 |
| VIEQUES | 0 | 0.0 | 3 | 22.7 |
| P R NO ESPECIFICADO | 0 | 0.0 | 0 | 0.0 |
| NO RESIDENTE | 0 | 0.0 | 4 | 38.8 |
| CANADA | 0 | 0.0 | 0 | 0.0 |
| CUBA | 0 | 0.0 | 0 | 0.0 |
| ESTADOS UNIDOS | 0 | 0.0 | 0 | 0.0 |
| GUAM | 0 | 0.0 | 0 | 0.0 |
| ISLAS VÍRGENES | 0 | 0.0 | 3 | 96.8 |
| MEJICO | 0 | 0.0 | 0 | 0.0 |
| REPÚBLICA DOMINICANA | 0 | 0.0 | 0 | 0.0 |
| OTROS PAÍSES | 0 | 0.0 | 1 | 14.1 |
| DESCONOCIDOS | 0 | 0.0 | 11 | 354.8 |

* TASAS POR 1,000 NACIDOS VIVOS - RATES PER 1,000 LIVE BIRTHS.

FUENTE: DEPARTAMENTO DE SALUD, SAPEESI, DIVISIÓN DE ESTADÍSTICAS, SAN JUAN, PUERTO RICO.

SOURCE: DEPARTMENT OF HEALTH, ASPESIS, DIVISION OF STATISTICS, SAN JUAN, PUERTO RICO.

Mapa 3 - TASAS* DE MORTALIDAD INFANTIL POR MUNICIPIOS Map 3 - INFANT MORTALITY RATES BY MUNICIPALITIES PUERTO RICO, 2001

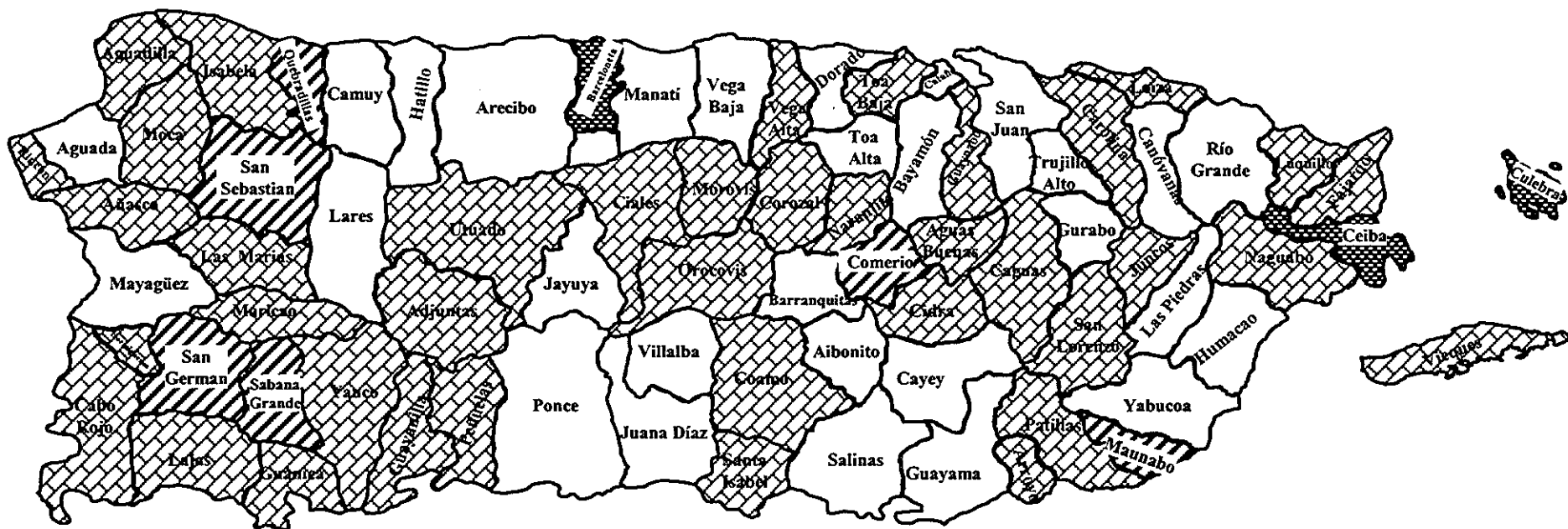

- Menos de 9.1 por 1000 - Less than 9.1 per 1000
- ▨ De 9.1 a 16.5 por 1000 - From 9.1 to 16.5 por 1000
- ▩ Más de 16.5 por 1000 - More than 16.5 per 1000
- Sin muertes infantiles - Without infant deads

* TASAS POR 1,000 HABITANTES - RATES PER 1,000 POPULATION
 FUENTE: DEPARTAMENTO DE SALUD, SAPEESI, DIVISI3N DE ESTADÍSTICAS, SAN JUAN, PUERTO RICO
 SOURCE: DEPARTMENT OF HEALTH, ASPEESI, DIVISION OF STATISTICS, SAN JUAN, PUERTO RICO

Tabla 12 - PRIMERAS DIEZ CAUSAS DE MORTALIDAD INFANTIL
 Table 12 - TEN LEADING CAUSES OF INFANT MORTALITY
 PUERTO RICO, 2001

| CAUSAS DE MUERTE CAUSES OF DEATH | NUMERO NUMBER | POR CIENTO PERCENT | TASAS 1/ RATES |
|--|------------------|-----------------------|-------------------|
| TODAS LAS CAUSAS ALL CAUSES | 515 | 100.0 | 919.9 |
| TRASTORNOS RELACIONADOS CON GESTACIÓN CORTA Y MALNUTRICIÓN DISORDER RELATED TO LENGTH OF GESTATION AND FETAL MALNUTRITION | 163 | 31.7 | 291.2 |
| MALFORMACIONES CONGÉNITAS, DEFORMIDADES Y ANOMALÍAS CROMOSÓMICAS CONGENITAL MALFORMATIONS, DEFORMATIONS AND CHROMOSOMAL ABNORMALITIES | 88 | 17.1 | 157.2 |
| OTROS TRASTORNOS RESPIRATORIOS ORIGINADOS EN EL PERÍODO PERINATAL OTHER RESPIRATORY CONDITIONS ORIGINATING IN THE PERINATAL PERIOD | 54 | 10.5 | 96.5 |
| DIFICULTAD RESPIRATORIA DEL RECIÉN NACIDO RESPIRATORY DISTRESS OF NEWBORN | 29 | 5.6 | 51.8 |
| OTRAS CONDICIONES PERINATALES OTHER PERINATAL CONDITION | 28 | 5.4 | 50.0 |
| SEPSIS BACTERIANA DEL RECIÉN NACIDO BACTERIAL SEPSIS OF NEWBORN | 22 | 4.3 | 39.3 |
| TRASTORNOS HEMATOLÓGICOS Y HEMORRAGICOS DEL RECIÉN NACIDO HEMORRHAGIC AND HEMATOLOGICAL DISORDERS OF NEWBORN | 17 | 3.3 | 30.4 |
| ENFERMEDADES DEL SISTEMA CIRCULATORIO DISEASES OF THE CIRCULATORY SYSTEM | 12 | 2.3 | 21.4 |
| SEPTICEMIA SEPTICEMIA | 12 | 2.3 | 21.4 |
| RECIÉN NACIDO AFECTADO POR FACTORES MATERNO Y POR COMPLICACIONES DEL EMBARAZO, PARTO Y ALUMBRAMIENTO NEWBORN AFFECTED BY MATERNAL FACTORS AND BY COMPLICATIONS OF PREGNANCY, LABOR AND DELIVERY | 10 | 1.9 | 17.9 |
| OTRAS CAUSAS OTHER CAUSES | 80 | 15.5 | 142.9 |

1/ TASA POR 100,000 NACIDOS VIVOS

FUENTE: DEPARTAMENTO DE SALUD, SAPEESI, DIVISI3N DE ESTADÍSTICAS, SAN JUAN, PUERTO RICO.

SOURCE: DEPARTMENT OF HEALTH, ASPESIS, DIVISION OF STATISTICS, SAN JUAN, PUERTO RICO.

Gráfica 13 - TASAS* DE MORTALIDAD INFANTIL Y MORTALIDAD FETAL POR AÑOS
Chart 13 - INFANT DEATH RATES AND FETAL DEATH BY YEARS
PUERTO RICO, 1960 - 2001

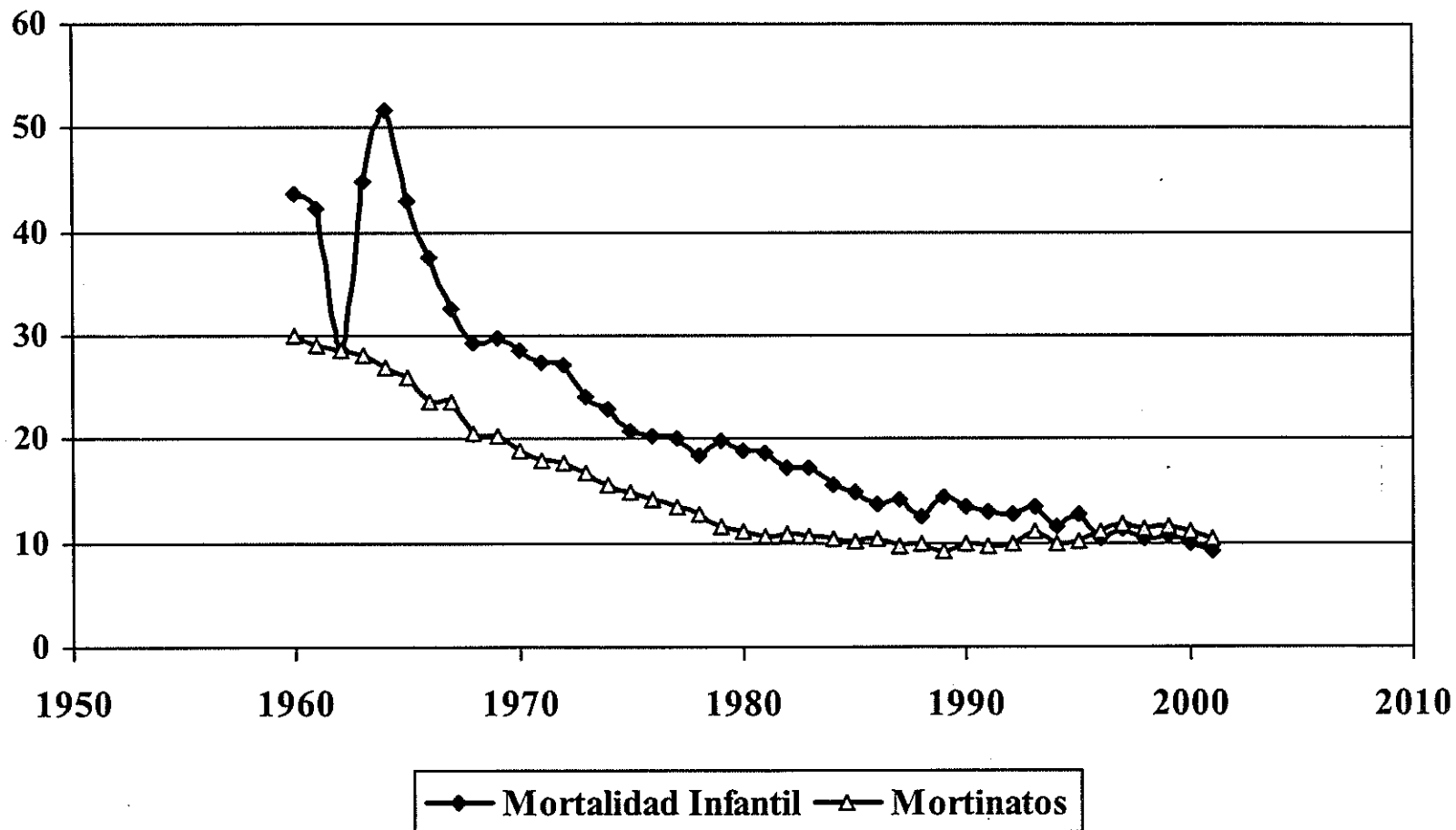

* TASAS POR 1,000 NACIDOS VIVOS, RATES PER 1,000 LIVE BIRTHS
 FUENTE: DEPARTAMENTO DE SALUD, SAPEESI, DIVISION DE ESTADISTICAS, SAN JUAN, PUERTO RICO
 SOURCE: DEPARTMENT OF HEALTH, ASPEESI, DIVISION OF STATISTICS, SAN JUAN, PUERTO RICO

Tabla 13 - PRIMERAS DIEZ CAUSAS DE MORTALIDAD NEONATAL
 Table 13 - TEN LEADING CAUSES OF NEONATAL MORTALITY
 PUERTO RICO, 2001

| CAUSAS DE MUERTE CAUSES OF DEATH | NUMERO NUMBER | POR CIENTO PERCENT | TASAS 1/ RATES |
|--|------------------|-----------------------|-------------------|
| TODAS LAS CAUSAS ALL CAUSES | 397 | 100.0 | 709.1 |
| TRASTORNOS RELACIONADOS CON GESTACIÓN CORTA Y MALNUTRICIÓN DISORDER RELATED TO LENGTH OF GESTATION AND FETAL MALNUTRITION | 158 | 39.8 | 282.2 |
| MALFORMACIONES CONGÉNITAS, DEFORMIDADES Y ANOMALÍAS CROMOSÓMICAS CONGENITAL MALFORMATIONS, DEFORMATIONS AND CHROMOSOMAL ABNORMALITIES | 68 | 17.1 | 121.5 |
| OTROS TRASTORNOS RESPIRATORIOS ORIGINADOS EN EL PERÍODO PERINATAL OTHER RESPIRATORY CONDITIONS ORIGINATING IN THE PERINATAL PERIOD | 52 | 13.1 | 92.9 |
| DIFICULTAD RESPIRATORIA DEL RECIÉN NACIDO RESPIRATORY DISTRESS OF NEWBORN | 29 | 7.3 | 51.8 |
| OTRAS CONDICIONES PERINATALES OTHER PERINATAL CONDITION | 26 | 6.5 | 46.4 |
| SEPSIS BACTERIANA DEL RECIÉN NACIDO BACTERIAL SEPSIS OF NEWBORN | 22 | 5.5 | 39.3 |
| TRASTORNOS HEMATOLÓGICOS Y HEMORRÁGICOS DEL RECIÉN NACIDO HEMORRHAGIC AND HEMATOLOGICAL DISORDERS OF NEWBORN | 16 | 4.0 | 28.6 |
| RECIÉN NACIDO AFECTADO POR FACTORES MATEERNAS Y POR COMPLICACIONES DEL EMBARAZO, PARTO Y ALUMBRAMIENTO NEWBORN AFFECTED BY MATERNAL FACTORS AND BY COMPLICATIONS OF PREGNANCY, LABOR AND DELIVERY | 10 | 2.5 | 17.9 |
| HIPOXIA INTRAUTERINA Y ASFIXIA DEL NACIMIENTO INTRAUTERINE HYPOXIA AND BIRTH ASPHYXIA | 4 | 1.0 | 7.1 |
| ENFERMEDADES DEL SISTEMA DIGESTIVO DISEASES OF THE DIGESTIVE SYSTEM | 1 | 0.3 | 1.8 |
| OTRAS CAUSAS OTHER CAUSES | 11 | 2.8 | 19.6 |

Nota: En un caso se conoce la causa de muerte pero no la edad. Por ello la suma de la mortalidad neonatal y postneonatal no coincide con la mortalidad infantil
 1/ TASA POR 100,000 NACIDOS VIVOS

FUENTE: DEPARTAMENTO DE SALUD, SAPEESI, DIVISIÓN DE ESTADÍSTICAS, SAN JUAN, PUERTO RICO.

SOURCE: DEPARTMENT OF HEALTH, ASPESIS, DIVISION OF STATISTICS, SAN JUAN, PUERTO RICO.

Tabla 14 - PRIMERAS DIEZ CAUSAS DE MORTALIDAD POSTNEONATAL
 Table 14 - TEN LEADING CAUSES OF POSNEONATAL MORTALITY
 PUERTO RICO, 2001

| CAUSAS DE MUERTE CAUSES OF DEATH | NÚMERO NUMBER | POR CIENTO PERCENT | TASAS 1/ RATES |
|--|------------------|-----------------------|-------------------|
| TODAS LAS CAUSAS ALL CAUSES | 117 | 100.0 | 209.0 |
| MALFORMACIONES CONGÉNITAS, DEFORMIDADES Y ANOMALÍAS CROMOSÓMICAS CONGENITAL MALFORMATIONS, DEFORMATIONS AND CHROMOSOMAL ABNORMALITIES | 20 | 17.1 | 35.7 |
| SEPTICEMIA SEPTICEMIA | 12 | 10.3 | 21.4 |
| ENFERMEDADES DEL SISTEMA CIRCULATORIO DISEASES OF THE CIRCULATORY SYSTEM | 11 | 9.4 | 19.6 |
| OTROS Y SIN ESPECIFICAR PROBLEMAS RESPIRATORIOS OTHER AND UNSPECIFIED DISEASES OF RESPIRATORY SYSTEM | 10 | 8.5 | 17.9 |
| ENFERMEDADES DEL SISTEMA DIGESTIVO DISEASES OF THE DIGESTIVE SYSTEM | 8 | 6.8 | 14.3 |
| ENFERMEDADES DEL SISTEMA NERVIOSO DISEASES OF THE NERVOUS SYSTEM | 7 | 6.0 | 12.5 |
| CAUSAS EXTERNAS DE MORTALIDAD EXTERNAL CAUSES OF MORTALITY | 7 | 6.0 | 12.5 |
| INFLUENZA Y NEUMONÍA INFLUENZA AND PNEUMONIA | 6 | 5.1 | 10.7 |
| TRASTORNOS RELACIONADOS CON GESTACIÓN CORTA Y MALNUTRICIÓN DISORDER RELATED TO LENGTH OF GESTATION AND FETAL MALNUTRITION | 5 | 4.3 | 8.9 |
| ENFERMEDADES ENDOCRINAS, NUTRICIONALES Y METABÓLICAS ENDOCRINE, NUTRITIONAL AND METABOLIC DISEASES | 5 | 4.3 | 8.9 |
| OTRAS CAUSAS OTHER CAUSES | 26 | 22.2 | 46.4 |

Nota: En un caso se conoce la causa de muerte pero no la edad. Por ello la suma de la mortalidad neonatal y postneonatal no coincide con la mortalidad infantil
 1/ TASA POR 100,000 NACIDOS VIVOS

FUENTE: DEPARTAMENTO DE SALUD, SAPEESI, DIVISIÓN DE ESTADÍSTICAS, SAN JUAN, PUERTO RICO.

SOURCE: DEPARTMENT OF HEALTH, ASPESIS, DIVISIÓN OF STATISTICS, SAN JUAN, PUERTO RICO.

Tabla 15 - MORTALIDAD MATERNA POR CAUSA Y GRUPOS DE EDAD
 Table 15 - MATERNAL MORTALITY BY CAUSE AND AGE GROUPS
 PUERTO RICO, 2001

| CAUSA - CAUSE | TOTAL | < 15 | 15 - 19 | 20 - 24 | 25 - 29 | 30 - 34 | 35 - 39 | 40 - 44 | 45 - 49 | 50 + | SIN ESPEC UNSPEC |
|--|-------|------|---------|---------|---------|---------|---------|---------|---------|------|------------------|
| COMPLICACIONES DEL EMBARAZO, DEL PARTO Y DEL PUERPERIO (O00-O99) COMPLICATIONS OF PREGNANCY, CHILDIRTH AND THE PUERPERIUM | 5 | - | - | 1 | 1 | 3 | - | - | - | - | - |
| ECLAMPSIA Y PRE-ECLAMPSIA (O11,013-016) ECLAMPSIA AND PRE-ECLAMPSIA | 1 | - | - | 1 | - | - | - | - | - | - | - |
| COMPLICACIONES PRINCIPALMENTE RELACIONADAS CON EL PUERPERIO (O85-O92) COMPLICATIONS PREDOMINANTLY RELATED TO PUERPERIUM | 2 | - | - | - | - | 2 | - | - | - | - | - |
| TODAS LAS OTRAS CAUSAS OBSTÉTRICAS DIRECTAS (O10,012,021-043,047-066,068-071,073-075) ALL OTHER DIRECT OBSTETRIC CAUSES | 2 | - | - | - | 1 | 1 | - | - | - | - | - |

FUENTE: DEPARTAMENTO DE SALUD, SAPEESI, DIVISIÓN DE ESTADÍSTICAS, SAN JUAN, PUERTO RICO.

SOURCE: DEPARTMENT OF HEALTH, ASPESIS, DIVISION OF STATISTICS, SAN JUAN, PUERTO RICO.

Gráfica 14 - TASA* DE MORTALIDAD MATERNA POR AÑOS
Chart 14 - MATERNAL MORTALITY RATES BY YEARS
PUERTO RICO, 1960 - 2001

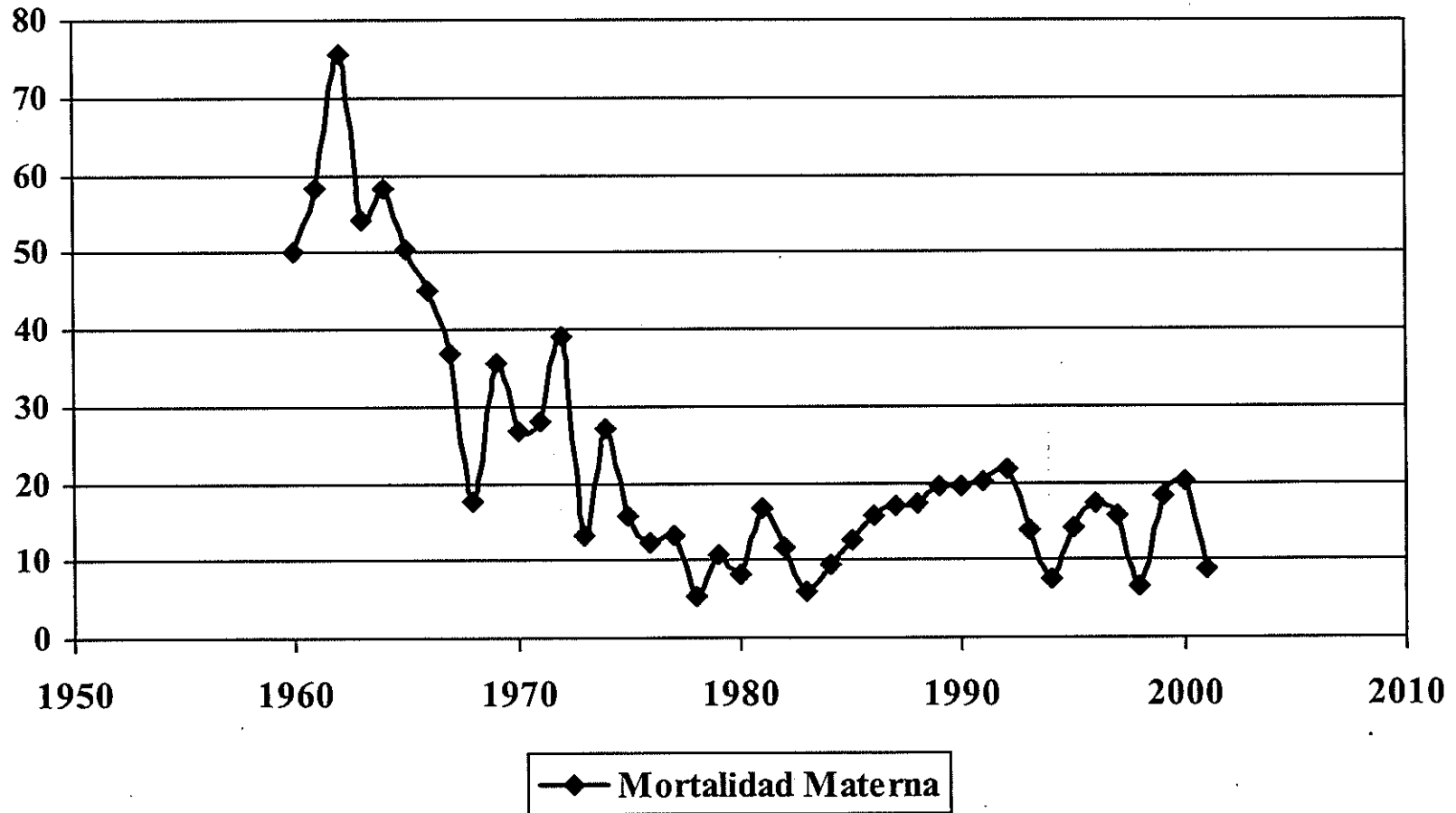

*TASAS POR 100,000 NACIDOS VIVOS, RATES PER 1,000 LIVE BIRTHS
 FUENTE: DEPARTAMENTO DE SALUD, SAPEESI, DIVISI3N DE ESTADÍSTICAS, SAN JUAN, PUERTO RICO
 SOURCE: DEPARTMENT OF HEALTH, ASPESIS, DIVISION OF STATISTICS, SAN JUAN, PUERTO RICO

Tabla 16 - TASAS DE MORTALIDAD MATERNA POR MUNICIPIO DE RESIDENCIA Y OCURRENCIA
 Table 16 - MATERNAL MORTALITY RATES BY MUNICIPALITY OF RESIDENCE AND OCCURRENCE
 PUERTO RICO, 2001

| MUNICIPIOS MUNICIPALITIES | OCURRENCIA OCCURRENCE | | RESIDENCIA RESIDENCE | |
|------------------------------|--------------------------|--------------|-------------------------|--------------|
| | NÚMERO NUMBER | TASA RATE | NÚMERO NUMBER | TASA RATE |
| TOTAL | 5 | 8.9 | 5 | 8.9 |
| BAYAMÓN | 1 | 30.8 | 2 | 27.8 |
| CAGUAS | - | - | 1 | 25.2 |
| CAMUY | 1 | 208.8 | - | - |
| MANATÍ | - | - | 1 | 29.3 |
| PONCE | - | - | 1 | 15 |
| SAN LORENZO | 1 | 192.7 | - | - |
| SANTA ISABEL | 1 | 244.5 | - | - |
| TOA BAJA | 1 | 70.9 | - | - |

*TASAS POR 100,000 NACIMIENTOS VIVOS

RATES BY 100,000 LIVE BIRTHS

FUENTE: DEPARTAMENTO DE SALUD, SAPEESI, DIVISIÓN DE ESTADÍSTICAS, SAN JUAN, PUERTO RICO.

SOURCE: DEPARTMENT OF HEALTH, ASPESIS, DIVISION OF STATISTICS, SAN JUAN, PUERTO RICO.

Gráfica 15 - TASAS* DE NUPCIALIDAD Y DIVORCIOS POR AÑOS
Chart 15 – MARRIAGE AND DIVORCE RATES BY YEARS
PUERTO RICO, 1960 - 2001

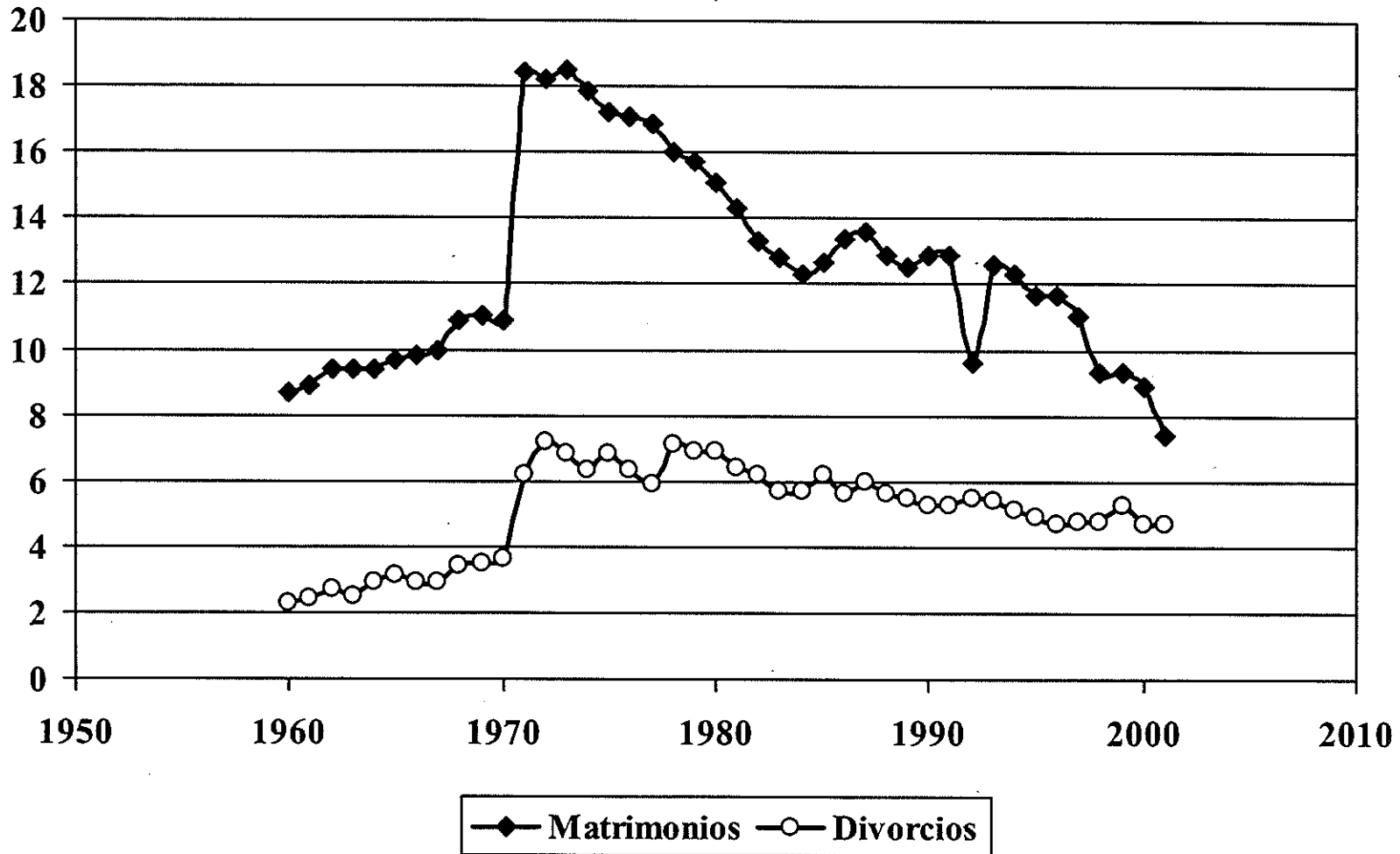

*TASAS POR 1,000 HABITANTES DE 15 AÑOS O MAS - RATES PER 1,000 POPULATION 15 YEARS OR OLDER
 FUENTE: DEPARTAMENTO DE SALUD, SAPEESI, DIVISIÓN DE ESTADÍSTICAS, SAN JUAN, PUERTO RICO
 SOURCE: DEPARTMENT OF HEALTH, ASPEESI, DIVISION OF STATISTICS, SAN JUAN, PUERTO RICO

Tabla 17 - MATRIMONIOS POR EDAD DE LOS CONTRAYENTES
Table 17 - MARRIAGES BY AGE OF BRIDE AND GROOM
PUERTO RICO, 2001

| EDAD DE LA CONTRAYENTE AGE OF THE BRIDE | EDAD DEL CONTRAYENTE - AGE OF GROOM | | | | | | | | | | | |
|---|-------------------------------------|----------|--------------|--------------|--------------|--------------|--------------|--------------|--------------|------------|--------------|----------------------|
| | TOTAL | <15 | 15 - 19 | 20 - 24 | 25 - 29 | 30 - 34 | 35 - 39 | 40 - 44 | 45 - 49 | 50 - 54 | 55+ | No Espec. Unspec. |
| TOTAL | 28,598 | 0 | 1,788 | 7,893 | 6,899 | 4,039 | 2,535 | 1,705 | 1,179 | 853 | 1,706 | 1 |
| < 15 | 98 | 0 | 44 | 43 | 10 | 0 | 1 | 0 | 0 | 0 | 0 | 0 |
| 15 - 19 | 4,196 | 0 | 1,220 | 2,137 | 602 | 172 | 47 | 7 | 3 | 5 | 3 | 0 |
| 20 - 24 | 8,554 | 0 | 438 | 4,284 | 2,639 | 788 | 255 | 102 | 33 | 9 | 6 | 0 |
| 25 - 29 | 6,009 | 0 | 66 | 1,099 | 2,591 | 1,331 | 543 | 228 | 97 | 30 | 24 | 0 |
| 30 - 34 | 3,326 | 0 | 18 | 241 | 697 | 1,042 | 674 | 354 | 148 | 82 | 70 | 0 |
| 35 - 39 | 2,218 | 0 | 2 | 61 | 253 | 434 | 592 | 400 | 241 | 129 | 106 | 0 |
| 40 - 44 | 1,579 | 0 | 0 | 17 | 74 | 189 | 289 | 367 | 287 | 181 | 175 | 0 |
| 45 - 49 | 1,021 | 0 | 0 | 7 | 26 | 62 | 95 | 165 | 237 | 194 | 235 | 0 |
| 50 - 54 | 678 | 0 | 0 | 2 | 5 | 17 | 30 | 59 | 92 | 139 | 334 | 0 |
| 55 + | 917 | 0 | 0 | 0 | 2 | 4 | 9 | 23 | 41 | 84 | 753 | 1 |
| NO ESPECIFICADA UNSPECIFIED | 2 | 0 | 0 | 2 | 0 | 0 | 0 | 0 | 0 | 0 | 0 | 0 |

FUENTE: DEPARTAMENTO DE SALUD, SAPEESI, DIVISI3N DE ESTADÍSTICAS, SAN JUAN, PUERTO RICO.

SOURCE: DEPARTMENT OF HEALTH, ASPESIS, DIVISION OF STATISTICS, SAN JUAN, PUERTO RICO.

Tabla 18 - MATRIMONIOS POR PRIMERA VEZ POR EDAD DE LOS CONTRAYENTES
Table 18 - FIRST MARRIAGE BY AGE OF BRIDE AND GROOM
PUERTO RICO, 2001

| EDAD DEL CONTRAYENTE AGE OF GROOM | EDAD DE LA CONTRAYENTE - AGE OF THE BRIDE | | | | | | | | | | | |
|---|---|-----------|--------------|--------------|--------------|--------------|------------|------------|------------|-----------|------------|----------------------|
| | TOTAL | <15 | 15 - 19 | 20 - 24 | 25 - 29 | 30 - 34 | 35 - 39 | 40 - 44 | 45 - 49 | 50 - 54 | 55+ | No Espec. Unspec. |
| TOTAL | 17,589 | 94 | 3,947 | 7,246 | 3,852 | 1,288 | 541 | 266 | 142 | 88 | 123 | 2 |
| < 15 | 0 | 0 | 0 | 0 | 0 | 0 | 0 | 0 | 0 | 0 | 0 | 0 |
| 15 - 19 | 1,727 | 44 | 1,213 | 413 | 50 | 7 | 0 | 0 | 0 | 0 | 0 | 0 |
| 20 - 24 | 7,118 | 43 | 2,067 | 3,998 | 832 | 143 | 27 | 4 | 2 | 0 | 0 | 2 |
| 25 - 29 | 5,087 | 6 | 510 | 2,159 | 1,927 | 362 | 93 | 19 | 9 | 1 | 1 | 0 |
| 30 - 34 | 1,995 | 0 | 115 | 482 | 753 | 459 | 121 | 45 | 16 | 2 | 2 | 0 |
| 35 - 39 | 820 | 1 | 33 | 146 | 191 | 198 | 159 | 66 | 16 | 9 | 1 | 0 |
| 40 - 44 | 360 | 0 | 5 | 35 | 59 | 81 | 82 | 55 | 23 | 17 | 3 | 0 |
| 45 - 49 | 179 | 0 | 2 | 10 | 30 | 19 | 34 | 36 | 35 | 11 | 2 | 0 |
| 50 - 54 | 112 | 0 | 1 | 2 | 6 | 8 | 14 | 27 | 21 | 20 | 13 | 0 |
| 55 + | 191 | 0 | 1 | 1 | 4 | 11 | 11 | 14 | 20 | 28 | 101 | 0 |
| NO ESPECIFICADA UNSPECIFIED | 0 | 0 | 0 | 0 | 0 | 0 | 0 | 0 | 0 | 0 | 0 | 0 |

FUENTE: DEPARTAMENTO DE SALUD, SAPEESI, DIVISI3N DE ESTADÍSTICAS, SAN JUAN, PUERTO RICO.

SOURCE: DEPARTMENT OF HEALTH, ASPESIS, DIVISION OF STATISTICS, SAN JUAN, PUERTO RICO.

Tabla 19 - MATRIMONIOS POR EDAD Y ESTADO CIVIL PREVIO DE LOS CONTRAYENTES
 Table 19 - MARRIAGES BY AGE AND PREVIOUS CIVIL STATUS OF BRIDE AND GROOM
 PUERTO RICO, 2001

DATOS DE LA CONTRAYENTE (BRIDE)

| EDAD AGE | TOTAL | SOLTERA SINGLE | VIUDA WIDOW | DIVORCIADA DIVORCED | NO ESP. UNSP. |
|--------------------------------|---------------|-------------------|----------------|------------------------|------------------|
| TOTAL | 28,598 | 21,314 | 587 | 6,697 | 0 |
| < 15 | 98 | 98 | 0 | 0 | 0 |
| 15 - 19 | 4,196 | 4,161 | 2 | 33 | 0 |
| 20 - 24 | 8,554 | 8,095 | 17 | 442 | 0 |
| 25 - 29 | 6,009 | 4,816 | 40 | 1,153 | 0 |
| 30 - 34 | 3,326 | 1,947 | 46 | 1,333 | 0 |
| 35 - 39 | 2,218 | 996 | 57 | 1,165 | 0 |
| 40 - 44 | 1,579 | 508 | 64 | 1,007 | 0 |
| 45 - 49 | 1,021 | 282 | 65 | 674 | 0 |
| 50 - 54 | 678 | 175 | 66 | 437 | 0 |
| 55 + | 917 | 234 | 230 | 453 | 0 |
| NO ESPECIFICADA UNSPECIFIED | 2 | 2 | 0 | 0 | 0 |

DATOS DEL CONTRAYENTE (GROOM)

| EDAD AGE | TOTAL | SOLTERO SINGLE | VIUDO WIDOW | DIVORCIADO DIVORCED | NO ESP. UNSP. |
|--------------------------------|---------------|-------------------|----------------|------------------------|------------------|
| TOTAL | 28,598 | 20,467 | 580 | 7,551 | 0 |
| < 15 | 0 | 0 | 0 | 0 | 0 |
| 15 - 19 | 1,788 | 1,783 | 0 | 5 | 0 |
| 20 - 24 | 7,893 | 7,602 | 9 | 282 | 0 |
| 25 - 29 | 6,899 | 5,830 | 16 | 1,053 | 0 |
| 30 - 34 | 4,039 | 2,586 | 32 | 1,421 | 0 |
| 35 - 39 | 2,535 | 1,230 | 34 | 1,271 | 0 |
| 40 - 44 | 1,705 | 601 | 31 | 1,073 | 0 |
| 45 - 49 | 1,179 | 327 | 27 | 825 | 0 |
| 50 - 54 | 853 | 192 | 57 | 604 | 0 |
| 55 + | 1,706 | 316 | 373 | 1,017 | 0 |
| NO ESPECIFICADA UNSPECIFIED | 1 | 0 | 1 | 0 | 0 |

FUENTE: DEPARTAMENTO DE SALUD, SAPEESI, DIVISIÓN DE ESTADÍSTICAS, SAN JUAN, PUERTO RICO.

SOURCE: DEPARTMENT OF HEALTH, ASPEESI, DIVISION OF STATISTICS, SAN JUAN, PUERTO RICO.

Tabla 20 - DIVORCIOS CONCEDIDOS EN LAS SALAS DEL TRIBUNAL GENERAL DE JUSTICIA POR SALA Y CAUSAL
 Table 20 - DIVORCES GRANTED BY CAUSES AT GENERAL JUSTICE TRIBUNAL COURTROOMS
 PUERTO RICO, 2001

| CAUSALES | Total | Aguadilla | Albionito | Arecibo | Bayamón | Caguas | Carolina | Fajardo | Guayama | Humacao | Mayagüez | Ponce | San Juan | Uttao |
|--|---------------|--------------|------------|--------------|--------------|--------------|--------------|------------|------------|------------|--------------|--------------|--------------|------------|
| Total | 13,870 | 1,229 | 356 | 1,075 | 1,646 | 1,551 | 1,633 | 101 | 542 | 513 | 1,088 | 1,297 | 2,443 | 396 |
| Consentimiento mutuo Mutual consent | 7,027 | 720 | 125 | 594 | 418 | 908 | 1,016 | 29 | 257 | 170 | 569 | 608 | 1,375 | 238 |
| Separación por más de dos años Separation for two or more years | 3,865 | 255 | 125 | 269 | 737 | 339 | 395 | 41 | 167 | 230 | 319 | 409 | 494 | 85 |
| Trato cruel Cruel treatment and graves injuries | 2,397 | 207 | 94 | 174 | 390 | 260 | 180 | 22 | 105 | 94 | 165 | 244 | 406 | 56 |
| Abandono por más de un año Abandonment for more than 1 year | 382 | 21 | 7 | 27 | 71 | 23 | 27 | 2 | 9 | 8 | 21 | 21 | 136 | 9 |
| Adulterio Adultery | 85 | 15 | 3 | 6 | 14 | 12 | 3 | 1 | 3 | 2 | 7 | 6 | 9 | 4 |
| Convicto a delito grave con pérdida derechos civiles Felony | 18 | 1 | 0 | 1 | 1 | 2 | 3 | 1 | 1 | 1 | 1 | 1 | 5 | 0 |
| Embriaguez habitual o uso continuo de narcóticos Habitual drunkenness or drugs | 12 | 0 | 0 | 0 | 1 | 7 | 0 | 1 | 0 | 1 | 1 | 0 | 1 | 0 |
| Exequatur Exequatur | 81 | 10 | 2 | 4 | 14 | 0 | 8 | 4 | 0 | 6 | 4 | 8 | 17 | 4 |
| Otras Causales Others Causals | 3 | 0 | 0 | 0 | 0 | 0 | 1 | 0 | 0 | 1 | 1 | 0 | 0 | 0 |

Fuente: Administración de Tribunales, Oficina de Estadísticas, San Juan, Puerto Rico.

Tabla 21 - DIVORCIOS CONCEDIDOS EN LAS SALAS DEL TRIBUNAL GENERAL DE JUSTICIA POR MES Y CAUSAL
 Table 21 - DIVORCES GRANTED AT GENERAL JUSTICE TRIBUNAL COURTROOMS BY CAUSES AND BY MONTH
 PUERTO RICO, 2001

| CAUSALES | Total | Enero | Febrero | Marzo | Abril | Mayo | Junio | Julio | Agosto | Septiembre | Octubre | Noviembre | Diciembre |
|--|---------------|------------|--------------|--------------|--------------|--------------|--------------|------------|--------------|--------------|--------------|--------------|--------------|
| Total | 13,870 | 941 | 1,214 | 1,406 | 1,040 | 1,178 | 1,395 | 713 | 1,396 | 1,306 | 1,151 | 1,076 | 1,054 |
| Consentimiento mutuo Mutual consent | 7,027 | 412 | 621 | 705 | 519 | 613 | 725 | 393 | 751 | 678 | 535 | 550 | 525 |
| Separación por más de dos años Separation for two or more years | 3,865 | 307 | 337 | 403 | 280 | 333 | 369 | 196 | 376 | 359 | 337 | 294 | 274 |
| Trato cruel Cruel treatment and graves injuries | 2,397 | 178 | 212 | 246 | 196 | 172 | 233 | 90 | 222 | 220 | 234 | 181 | 213 |
| Abandono por más de un año Abandonment for more than 1 year | 382 | 27 | 30 | 41 | 31 | 38 | 47 | 24 | 24 | 33 | 28 | 31 | 28 |
| Adulterio Adultery | 85 | 9 | 3 | 7 | 5 | 9 | 8 | 5 | 8 | 9 | 7 | 11 | 4 |
| Convicto a delito grave con pérdida derechos civiles Felony | 18 | 2 | 2 | 0 | 2 | 3 | 4 | 0 | 1 | 1 | 1 | 0 | 2 |
| Embriaguez habitual o uso continuo de narcóticos Habitual drunkenness or drugs | 12 | 1 | 2 | 0 | 1 | 0 | 1 | 1 | 4 | 0 | 0 | 1 | 1 |
| Exequatur Exequatur | 81 | 5 | 7 | 4 | 6 | 9 | 8 | 3 | 10 | 6 | 9 | 7 | 7 |
| Otras Causales Others Causals | 3 | 0 | 0 | 0 | 0 | 1 | 0 | 1 | 0 | 0 | 0 | 1 | 0 |

Fuente: Administración de Tribunales, Oficina de Estadísticas, San Juan, Puerto Rico.

